

Translations of

MATHEMATICAL MONOGRAPHS

Volume 140

Traveling Wave Solutions of Parabolic Systems

Aizik I. Volpert

Vitaly A. Volpert

Vladimir A. Volpert



American Mathematical Society
Providence, Rhode Island

А. И. Вольперт, Вит. А. Вольперт, Вл. А. Вольперт

БЕГУЩИЕ ВОЛНЫ, ОПИСЫВАЕМЫЕ
ПАРАБОЛИЧЕСКИМИ СИСТЕМАМИ

Translated by James F. Heyda from an original Russian manuscript

2000 *Mathematics Subject Classification*. Primary 35K55, 80A30;
Secondary 92E10, 80A25.

ABSTRACT. Traveling wave solutions of parabolic systems describe a wide class of phenomena in combustion physics, chemical kinetics, biology, and other natural sciences. The book is devoted to the general mathematical theory of such solutions. The authors describe in detail such questions as existence and stability of solutions, properties of the spectrum, bifurcations of solutions, approach of solutions of the Cauchy problem to waves and systems of waves. The final part of the book is devoted to applications to combustion theory and chemical kinetics.

The book can be used by graduate students and researchers specializing in nonlinear differential equations, as well as by specialists in other areas (engineering, chemical physics, biology), where the theory of wave solutions of parabolic systems can be applied.

Library of Congress Cataloging-in-Publication Data

Vol'pert, A. I. (Aizik Isaakovich)

[Begushchie volny, opisyyaemye parabolicheskimi sistemami. English]

Traveling wave solutions of parabolic systems/Aizik I. Volpert, Vitaly A. Volpert, Vladimir A. Volpert.

p. cm. — (Translations of mathematical monographs, ISSN 0065-9282; v. 140)

Includes bibliographical references.

ISBN 0-8218-4609-4 (acid-free)

1. Differential equations, Parabolic. 2. Differential equations, Nonlinear. 3. Chemical kinetics—Mathematical models. I. Volpert, Vitaly A., 1958–. II. Volpert, Vladimir A., 1954–. III. Title. IV. Series.

QA377.V6413 1994

515'.353—dc20

94-16518

© 1994 by the American Mathematical Society. All rights reserved.

The American Mathematical Society retains all rights
except those granted to the United States Government.

Printed in the United States of America.

Reprinted with corrections, 2000

∞ The paper used in this book is acid-free and falls within the guidelines
established to ensure permanence and durability.

Information on copying and reprinting can be found in the back of this volume.

This volume was typeset by the author using $\mathcal{A}\mathcal{M}\mathcal{S}\text{-T}\mathcal{E}\mathcal{X}$,
the American Mathematical Society's $\text{T}\mathcal{E}\mathcal{X}$ macro system.

Visit the AMS home page at URL: <http://www.ams.org/>

10 9 8 7 6 5 4 3 2 05 04 03 02 01 00

Contents

Preface	xi
INTRODUCTION. Traveling Waves Described by Parabolic Systems	1
§1. Classification of waves	2
§2. Existence of waves	11
§3. Stability of waves	16
§4. Wave propagation speed	22
§5. Bifurcations of waves	23
§6. Traveling waves in physics, chemistry, and biology	32
PART I. STATIONARY WAVES	
CHAPTER 1. Scalar Equation	39
§1. Introduction	39
§2. Functionals ω_* and ω^*	45
§3. Waves and systems of waves	51
§4. Properties of solutions of parabolic equations	72
§5. Approach to waves and systems of waves	85
§6. Supplement (Additions and bibliographic commentaries)	111
CHAPTER 2. Leray-Schauder Degree	121
§1. Introduction. Formulation of results	121
§2. Estimate of linear operators from below	128
§3. Functional $c(u)$ and operator $A(u)$	134
§4. Leray-Schauder degree	138
§5. Linearized operator	141
§6. Index of a stationary point	144
§7. Supplement. Leray-Schauder degree in the multidimensional case	149
CHAPTER 3. Existence of Waves	153
§1. Introduction. Formulation of results	153
§2. A priori estimates	159
§3. Existence of monotone waves	173
§4. Monotone systems	176
§5. Supplement and bibliographic commentaries	183
CHAPTER 4. Structure of the Spectrum	187
§1. Elliptic problems with a parameter	189
§2. Continuous spectrum	192
§3. Structure of the spectrum	198

§4. Examples	208
§5. Spectrum of monotone systems	212
CHAPTER 5. Stability and Approach to a Wave	217
§1. Stability with shift and its connection with the spectrum	218
§2. Stability of planar waves to spatial perturbations	225
§3. Conditions of instability	237
§4. Stability of waves for monotone systems	238
§5. On the solutions of nonstationary problems	242
§6. Approach to a monotone wave	250
§7. Minimax representation of the speed	254
PART II. BIFURCATION OF WAVES	
CHAPTER 6. Bifurcation of Nonstationary Modes of Wave Propagation	259
§1. Statement of the problem	259
§2. Representation of solutions in series form. Stability of solutions	263
§3. Examples	268
CHAPTER 7. Mathematical Proofs	273
§1. Statement of the problem and linear analysis	273
§2. General representation of solutions of the nonlinear problem. Existence of solutions	285
§3. Stability of branching-off solutions	295
PART III. WAVES IN CHEMICAL KINETICS AND COMBUSTION	
CHAPTER 8. Waves in Chemical Kinetics	299
§1. Equations of chemical kinetics	299
§2. Monotone systems	306
§3. Existence and stability of waves	312
§4. Branching chain reactions	316
§5. Other model systems	333
Bibliographic commentaries	335
CHAPTER 9. Combustion Waves with Complex Kinetics	337
§1. Introduction	337
§2. Existence of waves for kinetic systems with irreversible reactions	338
§3. Stability of a wave in the case of equality of transport coefficients	362
§4. Examples	366
Bibliographic commentaries	375
CHAPTER 10. Estimates and Asymptotics of the Speed of Combustion Waves	377
§1. Estimates for the speed of a combustion wave in a condensed medium	377
§2. Estimates for the speed of a gas combustion wave	392
§3. Determination of asymptotics of the speed by the method of successive approximations	400
Bibliographic commentaries	409

SUPPLEMENT. Asymptotic and Approximate Analytical Methods in Combustion Problems	411
§1. Narrow reaction zone method. Speed of a stationary combustion wave	411
§2. Stability of a stationary combustion wave	415
§3. Nonadiabatic combustion	416
§4. Stage combustion	418
§5. Transformations in a combustion wave	423
§6. Application of the methods of bifurcation theory to the study of nonstationary modes of propagation of combustion waves	426
§7. Surveys and monographs	431
Bibliography	433

Preface

The theory of traveling wave solutions of parabolic equations is one of the fast developing areas of modern mathematics. The history of this theory begins with the famous mathematical work by Kolmogorov, Petrovskii, and Piskunov and with works in chemical physics, the best known among them by Zel'dovich and Frank-Kamenetskiĭ in combustion theory and by Semenov, who discovered branching chain flames.

Traveling wave solutions are solutions of special type. They can be usually characterized as solutions invariant with respect to translation in space. The existence of traveling waves appears to be very common in nonlinear equations, and, in addition, they often determine the behavior of the solutions of Cauchy-type problems.

From the physical point of view, traveling waves usually describe transition processes. Transition from one equilibrium to another is a typical case, although more complicated situations can arise. These transition processes usually “forget” their initial conditions and reflect the properties of the medium itself.

Among the basic questions in the theory of traveling waves we mention the problem of wave existence, stability of waves with respect to small perturbations and global stability, bifurcations of waves, determination of wave speed, and systems of waves (or wave trains). The case of a scalar equation has been rather well studied, basically due to applicability of comparison theorems of a special kind for parabolic equations and of phase space analysis for the ordinary differential equations. For systems of equations, comparison theorems of this kind are, in general, not applicable, and the phase space analysis becomes much more complicated. This is why systems of equations are much less understood and require new approaches. In this book, some of these approaches are presented, together with more traditional approaches adapted for specific classes of systems of equations and for a more complete analysis of scalar equations. From our point of view, it is very important that these mathematical results find numerous applications, first and foremost in chemical kinetics and combustion. The authors understand that the theory of traveling waves is far from being complete and hope that this book will help in its development.

This book was basically written when the authors worked at the Institute of Chemical Physics of the Soviet Academy of Sciences. This scientific school, created by N. N. Semenov, Director of the Institute for a long time, by Ya. B. Zeldovich, who worked there, and by other outstanding personalities, has a strong tradition

of collaboration among physicists, chemists, and mathematicians. This special atmosphere had a strong influence on the scientific interests of the authors and was very useful to us. We would like to thank all our colleagues with whom we worked for many years and without whom this book could not have been written.

Aizik Volpert

Department of Mathematics, Technion, Haifa, 32000, Israel

Vitaly Volpert

Universite Lyon 1, CNRS, Villeurbanne Cedex, 69622 France

Vladimir Volpert

Northwestern University, Evanston, Illinois 60208

June 1993

INTRODUCTION

Traveling Waves Described by Parabolic Systems

Propagation of waves, described by nonlinear parabolic equations, was first considered in a paper by A. N. Kolmogorov, I. G. Petrovskii, and N. S. Piskunov [**Kolm 1**]. These mathematical investigations arose in connection with a model for the propagation of dominant genes, a topic also considered by R. A. Fisher [**Fis 1**]. Moreover, when [**Kolm 1**] appeared in 1937, the fact that waves can be described not only by hyperbolic equations, but also by parabolic equations, did not receive the proper attention of mathematicians. This is indicated by the fact that subsequent mathematical papers in this direction (Ya. I. Kanel' [**Kan 1, 2, 3**]) did not appear until more than twenty years later, although mathematical models, which form a basis for these papers, models of combustion, were formulated by Ya. B. Zel'dovich somewhat earlier (see, for example, [**Zel 4, 5**]). It was not until the seventies, under the influence of a great number of the most diverse problems of physics, chemistry, and biology, that an intensive development of this theme began.

At the present time a large number of papers is devoted to wave solutions of parabolic systems and this number continues to increase. In recent years, along with the study of one-dimensional waves, an interest in multi-dimensional waves has developed. This interest was stimulated by observation of spinning waves in combustion, spiral waves in chemical kinetics, etc.

The overwhelming number of natural science problems mentioned above leads to wave solutions of the parabolic system of equations

$$(0.1) \quad \frac{\partial u}{\partial t} = A\Delta u + F(u),$$

where $u = (u_1, \dots, u_m)$ is a vector-valued function, A is a symmetric nonnegative-definite matrix, Δ is the Laplace operator, and $F(u)$ is a given vector-valued function, which we will sometimes refer to as a source. System (0.1) is considered in a domain Ω of space \mathbb{R}^n on whose boundary, assuming Ω does not coincide with \mathbb{R}^n , boundary conditions are specified.

We attempt in the present introduction to give a general picture of current results concerning wave solutions of system (0.1) (see also [**Vol 47**]). Later on in the text we present in detail results of a general character, i.e., results connected with general methods of analysis and with sufficiently general classes of systems. In the remaining cases we limit ourselves to a brief exposition or to references to original papers. However, in selecting material for a detailed exposition interests of the authors are dominant.

Numbering of formulas and various propositions are carried out according to sections, the first digit indicating the section number. If in references the chapter is not indicated, it may be assumed that reference is being made to a section within the current chapter.

§1. Classification of waves

Waves described by parabolic systems can be divided into several classes. The most conventional is the class of waves referred to as stationary. By a *stationary wave* we mean a solution $u(x, t)$ of system (0.1) of the form

$$(1.1) \quad u(x, t) = w(x_1 - ct, x'),$$

where $w(x)$ is a function of n variables, $x = (x_1, \dots, x_n)$, $x' = (x_2, \dots, x_n)$, and c is a constant (speed of the wave). We assume here that Ω is a cylinder and that the system of coordinates is chosen so that axis x_1 is directed along the axis of the cylinder.

In recent years a large body of experimental material has accumulated and, in addition, a number of mathematical models connected with it have been studied in which not just stationary waves can be observed. In particular, we can observe *periodic waves*, defined as solutions $u(x, t)$ of system (0.1) of the form

$$(1.2) \quad u(x, t) = w(x_1 - ct, x', t),$$

where the function $w(x, t)$ is periodic in t ; Ω , as defined above, is a cylinder; and x_1 is directed along the axis of the cylinder.

Other forms of waves also occur, some of which we indicate below.

1.1. Stationary waves. We present a classification of stationary waves currently being studied. Part I of the present text is devoted to stationary waves.

1.1.1. *One-dimensional planar waves.* We consider system (0.1) with the following boundary condition on the surface of cylinder Ω :

$$(1.3) \quad \frac{\partial u}{\partial \nu} = 0,$$

where ν is the normal to the surface. We refer to a solution of the form

$$(1.4) \quad u(x, t) = w(x_1 - ct)$$

as a planar wave. This, obviously, corresponds to the definition given above of a stationary wave, one-dimensional in space, i.e., a solution of the system

$$(1.5) \quad \frac{\partial u}{\partial t} = A \frac{\partial^2 u}{\partial x_1^2} + F(u).$$

Function w of the variable $\xi = x_1 - ct$ is a solution of the following system of ordinary differential equations over the whole axis:

$$(1.6) \quad Aw'' + cw' + F(w) = 0.$$

Obviously, the system of equations (1.6) can be reduced to the system of first order equations

$$(1.7) \quad w' = p, \quad Ap' = -cp - F(w).$$

Thus, the problem of classifying planar waves can be reduced to the study of the trajectories of system (1.7). Apparently, however, not all trajectories are of interest. Solutions of system (1.6) are stationary solutions of system (1.5), written in coordinates connected with the front of a wave; of most interest are those waves which are stable stationary solutions.

We present a classification of planar waves encountered in applications.

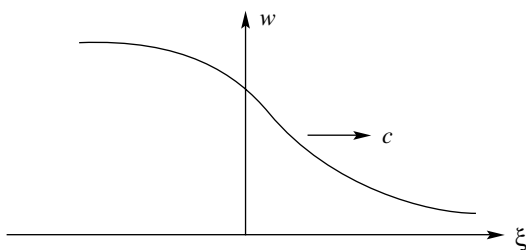

FIGURE 1.1. A monotone wave front

By *wave fronts* we mean solutions $w(\xi)$ of system (1.6), having limits as $\xi \rightarrow \pm\infty$,

$$(1.8) \quad \lim_{\xi \rightarrow \pm\infty} w(\xi) = w_{\pm},$$

where

$$(1.9) \quad w_+ \neq w_-.$$

Typical representatives of such waves are waves of combustion and waves in chemical kinetics, in particular, frontal polymerization, concentrational waves in Belousov-Zhabotinsky reactions, cold flames, etc. A characteristic form of a monotone wave front for each component of the vector-valued function w is shown in Figure 1.1. If we return to the initial coordinate x_1 , the wave front is then the profile shown in this figure moving along the x_1 -axis at constant speed c .

It is readily seen that we have the equalities

$$(1.10) \quad F(w_+) = 0, \quad F(w_-) = 0$$

if the function $w(\xi)$, together with its first derivative, is bounded on the whole axis and if the limits (1.8) exist. Actually, in this case it is easy to show that

$$w'(\xi) \rightarrow 0 \quad \text{and} \quad w''(\xi) \rightarrow 0 \quad \text{as} \quad |\xi| \rightarrow \infty,$$

and, passing to the limit in (1.6), we obtain (1.10).

Thus, w_+ and w_- are stationary points of the nondistributed system

$$(1.11) \quad \frac{du}{dt} = F(u),$$

corresponding to system (1.5). It turns out to be the case that in studying wave fronts connecting points w_+ and w_- (i.e., solutions of system (1.6) satisfying conditions (1.8)) it is very important to have information concerning stability of the stationary points w_+ and w_- . Obviously, only the following three types of sources $F(u)$ are possible:

- A.** Both points w_+ and w_- are stable stationary points of equation (1.11).
- B.** One of the points w_+ or w_- is stable, the other is unstable.
- C.** Both points w_+ and w_- are unstable.

As we shall show below, answers to questions concerning the existence of waves, their uniqueness, and a number of other questions, depend on the source type for $F(u)$.

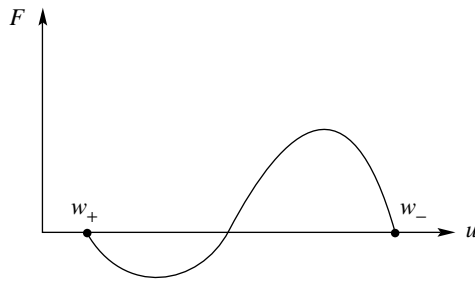

FIGURE 1.2. A Type A source (bistable case)

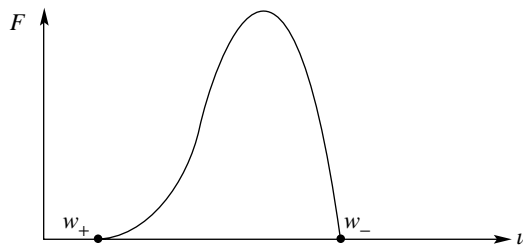

FIGURE 1.3. A Type A source (bistable case)

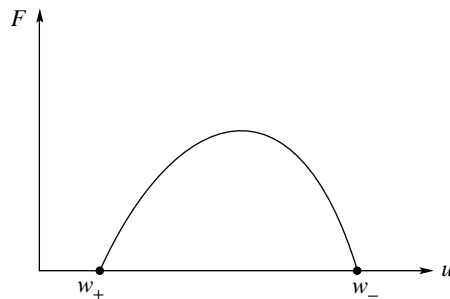

FIGURE 1.4. A Type B source (monostable case)

Sources of various types are shown in Figures 1.2–1.5 in the case of a scalar equation (1.5). Figures 1.2 and 1.3 display sources of Type A; Figures 1.4 and 1.5 display sources of types B and C, respectively. Sources shown in Figures 1.2, 1.4, and 1.5 are encountered in problems concerned with the propagation of dominant genes (see [Kolm 1] and [Aro 1]); the source shown in Figure 1.3 appears in problems of combustion (see [Zel 5]).

In the case of a Type A source we shall also say that we have a bistable case, for Type B sources a monostable case, and for Type C sources an unstable case.

Figure 1.6 depicts a Type A source of more complex form. It has a stable intermediate stationary point w_0 , so that one can speak of two waves: one joining point w_+ with w_0 , and one joining w_0 with w_- ; one can also speak of the wave

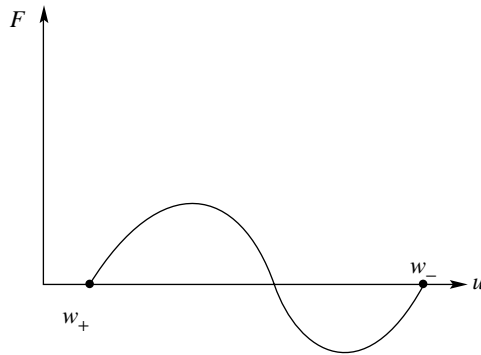

FIGURE 1.5. A Type C source (unstable case)

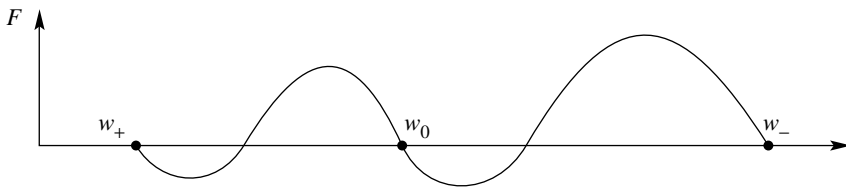

FIGURE 1.6. A Type A source with a stable intermediate stationary point

joining w_+ with w_- . We shall concern ourselves with the question of which waves may be realized in actuality when, in what follows, we discuss systems of waves.

Pulses differ from wave fronts only by the fact that, instead of (1.9), we have the equality

$$(1.12) \quad w_+ = w_-.$$

Currently, the most studied equations describing pulses (as well as periodic waves, see below) are the equations for propagation of nerve impulses, namely, the Hodgkin-Huxley equations and the simpler Fitz-Hugh-Nagumo equations, which are special cases of system (1.5). The characteristic form of the pulses described by the equations mentioned is shown in Figures 1.7 and 1.8 on the next page.

Waves periodic in space are solutions of system (1.6) for which the function $w(\xi)$ is periodic. Periodic waves were discovered in problems of propagation of nerve impulses and in problems of chemical kinetics. Corresponding to them in the phase plane are the limit cycles of system (1.7).

1.1.2. *Multi-dimensional waves* are solutions of the form (1.1) which cannot be written in the form (1.4). Experimentally such waves may be observed as a uniform displacement of a “curved” front along the axis of the cylinder. Obviously, if instead of boundary condition (1.3) we consider a different boundary value problem, for example, of the first or the third kind, then a stationary wave, if it exists, is multi-dimensional. However, even in the case of condition (1.3) multi-dimensional waves can also be realized.

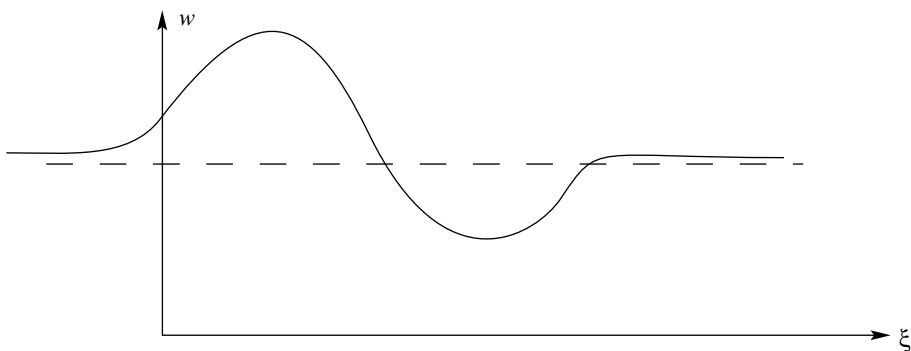

FIGURE 1.7. A wave solution in the form of a pulse

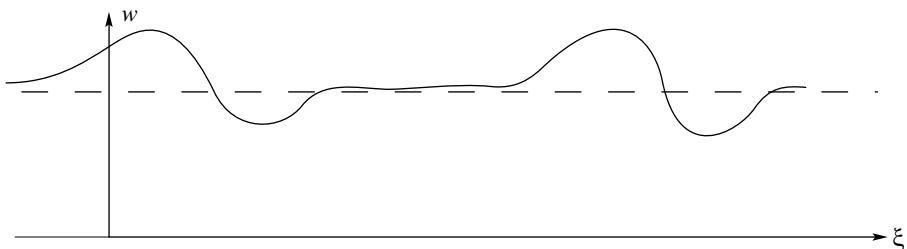

FIGURE 1.8. A wave solution in the form of a pulse

Let us assume that the following limits exist:

$$(1.13) \quad \lim_{\xi \rightarrow \pm\infty} w(\xi, x') = w_{\pm}(x').$$

We can then expect that the function $w_{\pm}(x')$ will satisfy the equation

$$(1.14) \quad \Phi(w_{\pm}) = 0.$$

Here Φ is the nonlinear operator

$$(1.15) \quad \Phi(u) = A\Delta' u + F(u),$$

where Δ' is the Laplace operator in the variables $x' = (x_2, \dots, x_n)$. The operator $\Phi(u)$ is considered on functions given in a cross-section of the cylinder Ω , satisfying the same boundary conditions as in the initial problem (for simplicity we assume that in these conditions there is no dependence on x_1).

Here, as we did in the one-dimensional formulation, we can speak of three cases A, B, and C, except that here, instead of equation (1.11), we must consider the operator equation

$$(1.16) \quad \frac{du}{dt} = \Phi(u).$$

1.2. Periodic waves. Periodic waves, determined by equation (1.2), describe various processes that were observed in combustion (see the supplement to Part III) and other physico-chemical processes (see, for example, [Beg 1]). Currently, the

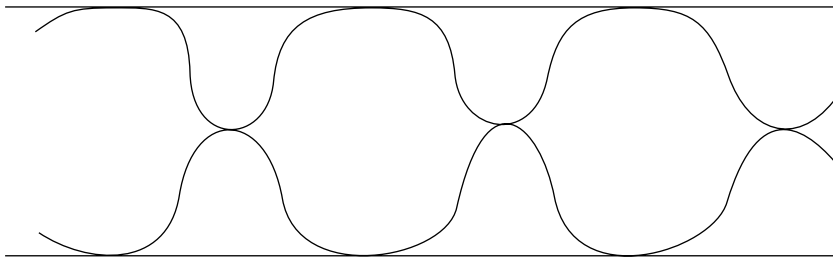

FIGURE 1.9. Two-spot mode of wave propagation in a strip

basic general methods for studying periodic waves are the methods of bifurcation theory (see below). We now present some forms of periodic waves encountered in applications.

It is convenient to describe the character of wave propagation by considering the motion of certain characteristic points, for example, maximum points of solutions. We shall refer to these maximum points as *hot spots*. This type of terminology arose in experiments dealing with combustion, where luminous spots, corresponding to maximum points of the temperature, were observed propagating along the specimen.

1.2.1. *One-dimensional waves* are solutions of system (1.5) of the form $w(x_1 - ct, t)$, where $w(\xi, t)$ is a periodic function of t . As an example of a physical model we cite the oscillatory mode of combustion (see [Shk 3]) in which a planar front of combustion performs periodic oscillations relative to a uniformly moving coordinate frame. We remark that the character of the oscillations can be fairly complex. In particular, in numerical modeling of combustion problems, bifurcations have been observed leading to the successive doubling of the period, and then to irregular oscillations [Ald 6, Dim 1, Bay 4].

1.2.2. *Two-dimensional waves* are solutions of the form (1.2) of system (0.1), considered in an infinite strip of width l : $-\infty < x_1 < +\infty$, $0 \leq x_2 \leq l$. We shall assume that condition (1.3) is satisfied. The nature of the wave propagation manifests itself by motion of the hot spots. A planar wave propagates along the strip when the width of the strip is sufficiently small. As l increases, a critical value $l = l_1$ is attained and a *one-spot* mode of wave propagation then arises: the spot moves along the line $x_2 = 0$, then moves onto the line $x_2 = l$, after which the motion of the spot again takes place along the line $x_2 = 0$, and so on, in a periodic fashion. With further widening of the strip a second critical value $l = l_2$ appears, giving rise to a *two-spot* mode. The spots move simultaneously along the lines $x_2 = 0$ and $x_2 = l$, after which, moving towards one another, they merge onto the line $x_2 = l/2$ and move along this line: they then diverge and, once again, two spots appear on the lines $x_2 = 0$ and $x_2 = l$, after which the motion described is repeated. Depending on how much the width of the strip is increased, at some $l = l_3$ a three-spot mode appears, and so forth. Such modes for combustion of a plate were obtained numerically in [Ivl 3]. A two-spot mode is shown in Figure 1.9.

1.2.3. *Spinning waves*. We consider the case of a three-dimensional space ($n = 3$) and a circular cylinder Ω , along whose axis a wave is propagating. We introduce polar coordinates r and φ in a disk cross-section of the cylinder. By a

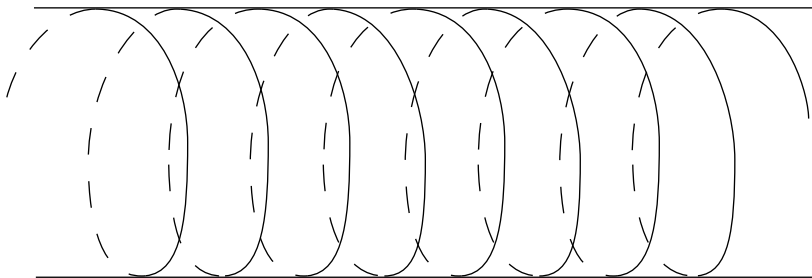

FIGURE 1.10. One-spot spinning mode of wave propagation in a circular cylinder

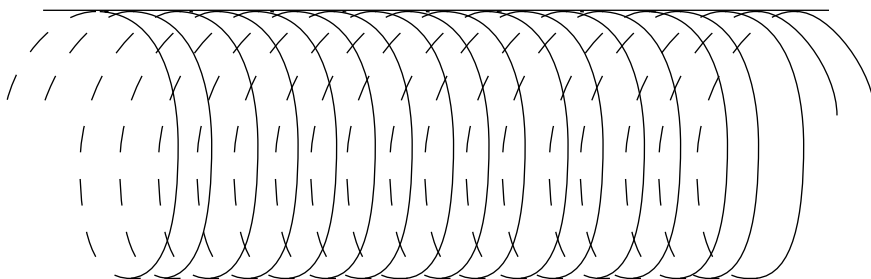

FIGURE 1.11. Two-spot spinning mode of wave propagation in a circular cylinder

spinning wave we mean a solution of system (0.1) of the form

$$u(x, t) = w(x_1 - ct, r, \varphi - \sigma t),$$

where c and σ are constants; c is the speed of propagation along the axis of the cylinder, σ is the angular rate.

Spinning waves were observed in the combustion of condensed systems [Mer7] as the motion of luminous spots along a spiral on the surface of the cylindrical specimen. Spinning wave propagation patterns were studied experimentally, in particular, their dependence on the radius of the cylinder. It was established that for small radii the spinning mode is not present; with an increase in the radius a one-spot spinning mode appears (Figure 1.10); next, a two-spot mode appears (Figure 1.11) when two spots move simultaneously along a spiral, and so forth.

1.2.4. *Symmetric waves.* In studies made using methods of bifurcation theory [Vol 13, 21, 30] waves coexisting with spinning waves were observed in a circular cylinder. These were called symmetric waves (they are also called standing waves). An analysis of the stability of these waves (see Chapter 6) showed that spinning and symmetric waves cannot be simultaneously stable at their birth occurring as the result of a loss of stability of a plane wave. Symmetric waves, just like spinning waves, can have one spot, two spots, etc. In a *one-spot* symmetric mode motion of the spots proceeds as follows: a spot moves along the surface of the cylinder parallel to its axis; it then bifurcates and two spots appear, moving along the surface and meeting on the diametrically opposite side of the cylinder surface, etc. in a periodic mode. A one-spot symmetric mode is depicted in Figure 1.9 if we

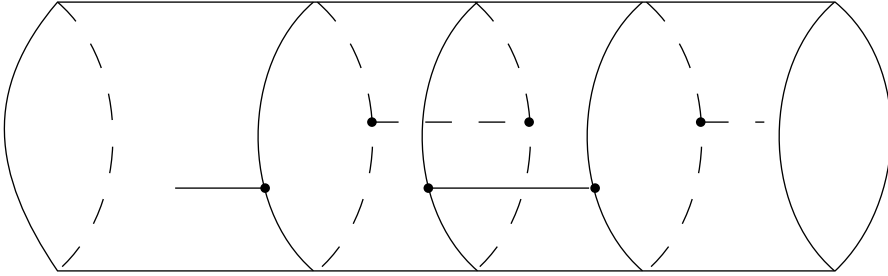

FIGURE 1.12. One-spot symmetric mode of wave propagation on the surface of a cylinder

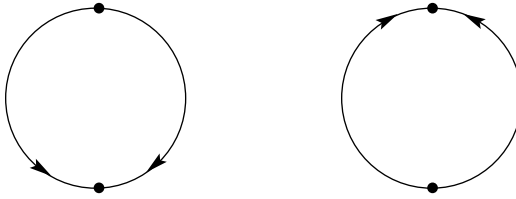

FIGURE 1.13. An end-view of a one-spot symmetric mode

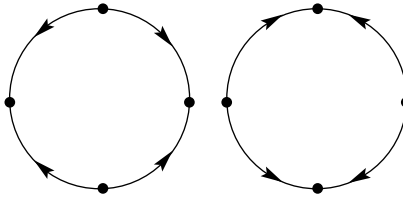

FIGURE 1.14. An end-view of a two-spot symmetric mode

identify lines bounding the strip from its sides. A direct representation of a one-spot symmetric mode on the surface of a cylinder is shown in Figure 1.12. An end-view is shown in Figure 1.13. Motion of the spots in the case of a *two-spot* symmetric mode is completely analogous, except that now two spots, located at diametrically opposite points of the surface, move simultaneously; each of the spots bifurcates and they meet at points shifted with respect to the initial points by an angle $\pi/2$. Figure 1.14 depicts an end-view of a two-spot symmetric mode.

The question as to whether a symmetric mode in combustion has been observed experimentally is an open one. In experiments modes have been observed in which the spots move along the surface of a circular cylinder towards each other; unfortunately, however, there is no detailed description of these modes. It can be assumed that these modes are symmetric.

1.2.5. *Radial waves.* We have in mind periodic waves in a circular cylinder, i.e., waves of the form (1.2) in which there is no dependence on angle, so that motion takes place along the axis of the cylinder and in the direction of the radius. Obviously, such waves can be considered in a section of the cylinder by plane $x_1 = 0$ and a corresponding body of revolution about the axis of the cylinder can be obtained. As bifurcation analysis shows, such waves can exist with a various number of spots. In the case of a one-spot mode, motion of the spots takes place

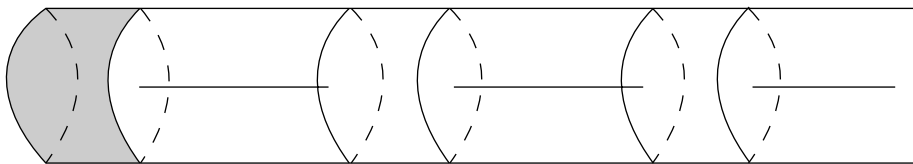

FIGURE 1.15. One-spot radial wave

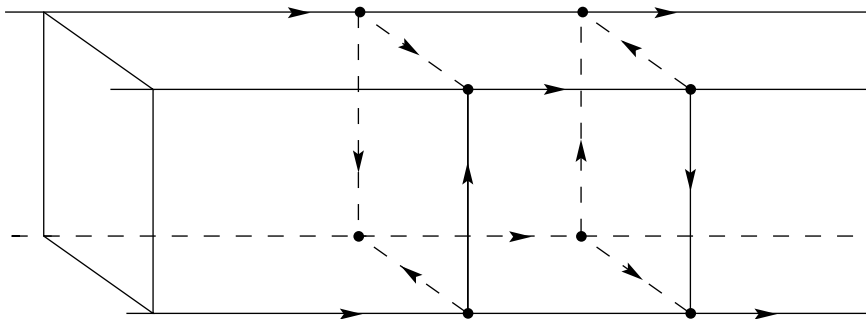

FIGURE 1.16. A mode of wave propagation in a cylinder of rectangular cross-section

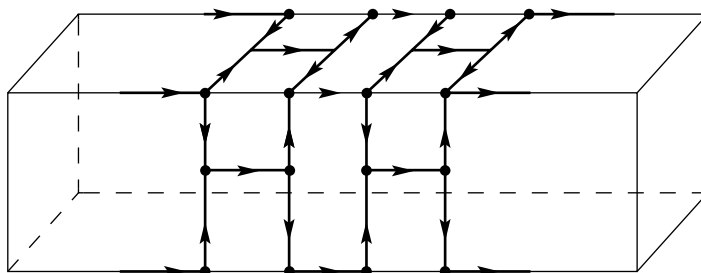

FIGURE 1.17. A mode of wave propagation in a cylinder of rectangular cross-section

as follows: a spot moves along the axis of the cylinder, then goes over onto the surface, fills in a complete circle, then again falls onto the axis, and so forth (see Figure 1.15). A mode of this kind has been observed in combustion [Mak 3].

REMARK. As follows from a bifurcation analysis (see below), with a loss of stability of a planar wave such that a pair of complex conjugate eigenvalues goes across the imaginary axis, there generically arise, in the circular cylinder, periodic waves of four and only four types: one-dimensional, spinning, symmetric, and radial.

1.2.6. *Waves in a cylinder of rectangular cross-section.* In this case various modes of propagation of the spots are possible. They have been studied by the methods of bifurcation theory (see §5). Two of these are shown in Figures 1.16 and 1.17. Modes of this kind were obtained experimentally in combustion [Vol 32].

We restrict the discussion here to cylinders with circular and rectangular cross-sections. Cylinder of arbitrary cross-section will be discussed in §5.

1.2.7. *Waves of more complex structure.* We have enumerated in some sense the simplest forms of periodic waves. All of them can be obtained as bifurcations in the vicinity of a planar wave. More complex waves are also possible, being obtained through interaction of modes already described. Such waves emerge during computer calculations, for example, as secondary bifurcations. As examples, we can point to the birth of symmetric waves from developed one-dimensional oscillations [Meg 1, 2], and also, waves which appear as the rotation of “curved” fronts [Buc 3].

1.3. Other forms of waves. Along with the waves presented above, other forms of waves are encountered.

1.3.1. *Rotating and spiral waves.* Rotating waves are similar to spin waves, differing only in that propagation is with respect to an angular coordinate. The pertinent domain Ω is a body of revolution about an axis (or about a point for $n = 2$).

Spiral waves have been observed experimentally in chemical kinetics, wherein the spot of a chemical reaction moves along a spiral. In this case Ω is taken to be a plane, and rotation of the wave is described in polar coordinates with simultaneous propagation along a radius. Three-dimensional spiral waves have also been studied.

Rotating and spiral waves have been discussed in a large number of papers (see [Ale 1, Ang 1, Auc 1, 2, Bark 1, Bern 1, Brazh 1, Coh 1, Duf 1, Ern 1, 2, Gom 1, Gre 1–4, Grin 1, Hag 4, Kee 1, 2, Koga 1, Kop 6, Kri 1–3, Nan 1, Ort 1, Pelc 1, Ren 1, Win 1–3]).

1.3.2. *Target type waves.* Waves of this kind are observed experimentally in chemical kinetics as concentric waves diverging from a center with simultaneous generation of new waves at the center. References concerned with these waves are [Erm 4, Fife 4, 5, Hag 2, Kop 1, 2, 5, 6, Tys 1].

1.4. Systems of waves. A study of the behavior of solutions of a Cauchy problem for system (0.1) for large values of t shows that it is not always single waves that are involved. We arrive at this conclusion already in the study of a scalar equation in the one-dimensional case. This has already been mentioned for the source shown in Figure 1.6. Possible waves here are $[w_+, w_0]$ -, $[w_0, w_-]$ -, and $[w_+, w_-]$ -waves, where we use the notation $[w_{\pm}, w_0]$ to show that the waves connect the points w_{\pm} and w_0 . In Figure 1.18 the possible cases are shown schematically: $[w_0, w_-]$ -wave with a speed c_- , $[w_+, w_0]$ -wave with a speed c_+ . Existence of a $[w_+, w_-]$ -wave depends on the relationship between the speeds c_+ and c_- . If $c_- > c_+$, then the $[w_0, w_-]$ -wave overtakes the $[w_+, w_0]$ -wave; the waves then merge and the wave $[w_+, w_-]$ emerges as a solitary wave with an intermediate speed. But if $c_- \leq c_+$, then the two waves coexist and we have a system of waves. Studies presented in Chapter 1 show that in precisely this way an asymptotic solution of system (0.1) is obtained as $t \rightarrow \infty$.

Systems of waves, or in other terminology wave trains, or minimal decomposition of waves, were studied first from the physical point of view in combustion theory [Kha 3, Mer 6] and mathematically in [Fife 7].

§2. Existence of waves

2.1. Methods of proof for the existence of waves. At the present time there is a large number of papers concerned with the existence of waves in which

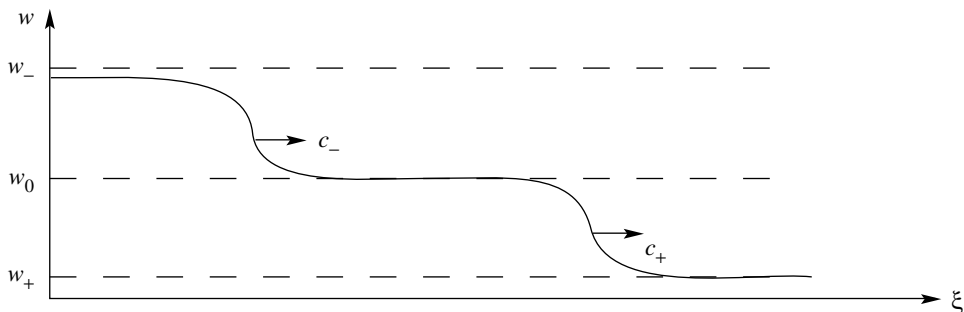

FIGURE 1.18. A system of waves (wave train)

various methods of analysis are employed. It appears, however, that we can single out three basic approaches:

1. Topological methods, in particular, the Leray-Schauder method.
2. Reduction of a system of equations of the second order to a system of first order ordinary equations and various methods of analyzing the trajectories of this system (for one-dimensional waves).
3. Methods of bifurcation theory.

Other methods are also in use. In this section, and in the supplement to Chapter 3, we attempt briefly to characterize the known methods and results on the existence of waves. A more detailed discussion of the Leray-Schauder method will be given; we develop this method in the text in connection with wave solutions of parabolic systems and, as it appears to us, it is a very promising method. We remark that in the overwhelming majority of papers the existence of waves for systems of equations is discussed in the one-dimensional case.

2.1.1. *Leray-Schauder method.* As is well known, the Leray-Schauder method consists in constructing a continuous deformation of an initial system to a model system for which it is known that solutions exist and possess the required properties. For these systems we consider the vector field generated by them in a functional space, and we assume that a homotopic invariant is defined, namely, rotation of the vector field, or, in other terminology, the Leray-Schauder degree, satisfying the following properties:

1. Principle of nonzero rotation.

If on the boundary of a domain in a functional space the degree is defined and different from zero, then in this domain there are stationary points.

2. Homotopic invariance.

If during a continuous deformation of a system the solution does not reach the boundary of a domain, then the degree does not vary on this boundary.

Thus, if we have a priori estimates of solutions, i.e., in a homotopy process solutions are found in some ball in functional space, and if for a model system the degree on the ball boundary is different from zero, then it is also different from zero for the initial system. Consequently, solutions also exist for the initial system.

Thus, to apply the Leray-Schauder method it is necessary to define the degree with the indicated properties; to construct a model system for which the degree is different from zero on the boundary of a ball of sufficiently large radius; and to construct a continuous deformation of the initial system to the model system such that there are a priori estimates of solutions.

Rotation of a vector field for completely continuous vector fields is well defined and widely applied, in particular, in proving existence of solutions by the Leray-Schauder method. Systems of equations of the type (1.6) can be reduced to completely continuous vector fields, but only in case they are considered in bounded domains (see §1 of Chapter 2). For waves, i.e., for solutions considered in unbounded domains, one cannot make use of an existing theory for completely continuous vector fields, and this is actually the case. Essentially the situation is the following.

To construct the degree it is necessary to select, in an appropriate way, a functional space and to define an operator A vanishing on solutions of system (1.6), i.e., on waves. A vector field will thereby be determined. Operator A can be approximated in various ways by operators A_n , which correspond to completely continuous vector fields and for which the degree can be defined in the usual way. Moreover, this can be done so that the degree for operators A_n is independent of n if n is sufficiently large, and we can take this quantity as the degree of operator A . If $\gamma(A, D)$, the degree of operator A on the boundary of domain D , is different from zero, then $\gamma(A_n, D)$ will also be different from zero; consequently, there exists a sequence of functions u_n , belonging to domain D , for which $A_n(u_n) = 0$. This sequence is bounded (domain D is assumed to be bounded) and, consequently, some subsequence converges weakly. The main difficulty here is that the weak limit of this sequence may not belong to domain D , and, as a consequence, the principle of nonzero rotation can be violated. To avoid this situation we need to show, for the class of operators considered, that weak convergence of solutions implies strong convergence (precise statements appear in Chapter 2). To proceed we need to obtain estimates from below for operator A . These estimates for operators corresponding to the system of equations (1.6) were obtained, thereby making it possible to define the degree by Skrypnik's method [Skr 1]. It should be noted that rotation of a vector field possessing the usual properties cannot be constructed in an arbitrary functional space. Even in the case of a scalar equation it is easy to give an example whereby, in the space of continuous functions C , a wave under deformation disappears with no violation of a priori estimates. This is connected with the fact that during motion with respect to a parameter a wave can be attracted to an intermediate stationary point and, instead of a wave satisfying conditions (1.8), we will have a system of waves. In constructing the degree for operators describing traveling waves, it is convenient to use weighted Sobolev spaces.

Yet another difficulty arising here is that solutions of equation (1.6) are invariant with respect to a translation in the spatial variable. In addition, the speed c of the wave is an unknown and must also be found in solving the problem. It is therefore convenient in the study of waves to introduce a functionalization of the parameter. This means that the speed of the wave is considered not as an unknown constant, but as a given functional defined on the same space as operator A . Here the value of the functional depends on the magnitude of the translation of the stationary solution, making it possible to single out one wave from a family of waves. Thus functionalization of a parameter allows us to consider an isolated stationary point in a given space instead of a whole line of stationary points.

We remark that the degree for operators describing traveling waves is defined without any assumptions as to the form of the nonlinearity of $F(u)$, except, naturally, for smoothness and stability of the points w_{\pm} . This result, apparently, can be rather easily generalized to the multi-dimensional case. As for the monostable case, there arise here additional complexities associated with the facts that waves exist

for a whole half-interval (half-axis) of speeds and form an entire family of solutions. It can be expected that the degree can be successfully introduced with a proper selection of weighted norms, identifying a single wave (a single speed) of a family of waves.

Having defined the degree, we see that the possibility of obtaining a priori estimates of solutions also determines the class of systems for which we can successfully apply the Leray-Schauder method to prove the existence of waves. (The construction of a model system can be carried out rather easily and is, in the main, of a technical nature.) Hitherto it has been possible to do this for locally-monotone systems (see §2.2), yet one may expect that there exist other types of nonlinearities also for which a priori estimates of solutions can be obtained. It should be noted that the problem of obtaining a priori estimates in one form or another also arises for other methods of proving the existence of waves; one should therefore not assume that this restricts the application of the Leray-Schauder method in comparison with other approaches.

2.1.2. *Other methods for proving the existence of waves.* A widely used method is one based on phase portrait analysis. This means that the system of equations (1.6) is placed into correspondence with the first order system of equations (1.7). As has already been noted, its trajectories correspond to waves. In particular, if the question concerns waves satisfying conditions (1.8), i.e., wave fronts or pulses, we then have in mind trajectories of system (1.7) joining the stationary points $(w_+, 0)$ and $(w_-, 0)$ in the phase space (w, p) . To periodic waves there correspond limit cycles.

Thus the problem of proving existence of waves reduces to proving existence of corresponding trajectories of system (1.7).

This method is very suitable when applied to a scalar equation. Actually, in this case (1.7) is a system of two equations and the analysis is carried out in the two-dimensional phase plane, a situation rather well studied. To prove existence of wave fronts a trajectory is drawn off from one of the stationary points $(w_+, 0)$ or $(w_-, 0)$ and it is proved that the constant c can be selected so that this trajectory reaches the other of these stationary points. Precisely this method was used for the first time in [Kolm 1] to prove the existence of a wave.

The situation is far more involved for the system of equations (1.6). Here it is necessary to consider a phase space of dimensionality greater than or equal to 4; application of the method indicated entails essential difficulties. To successfully apply this method one must deal with a system of special form, possessing specific properties. It is of interest to note that many systems arising in various physical problems possess the required properties. Therefore, it is this approach that was successfully used to prove the existence of wave fronts in various mathematical models of physics, chemistry, and biology (see Chapter 3, §5).

To prove the existence of a pulse, it is obviously sufficient to establish in the phase plane (w, p) the existence of a trajectory of system (1.7) leaving and entering the stationary point $(w_+, 0)$. In the general case only results obtained with the aid of bifurcation theory are available: under certain conditions birth of a separatrix loop from the stationary points may be proved.

One of the general approaches to proving the existence of periodic waves also yields a theory of bifurcations. The question concerns birth of periodic waves of small amplitude from constant stationary solutions under a change of parameters (see below). Another approach to proving the existence of periodic waves is

connected with an assumption concerning the existence of stable limit cycles for the system (1.11). Use is made of the small parameter method: for large speeds c a small parameter can be introduced into system (1.6) so that as $c \rightarrow \infty$ we obtain system (1.11).

Results concerning the existence of multi-dimensional waves for scalar equations are presented in the supplement to Chapter 1. Multi-dimensional waves close to planar waves have been studied by methods of bifurcation theory (see §5).

2.2. Locally-monotone and monotone systems. Scalar equation. In this subsection we present basic results on the existence of waves of wavefront type for a class of systems of equations. We assume that the matrix A is a diagonal matrix and that the vector-valued function $F(u)$ satisfies the conditions

$$(2.1) \quad \frac{\partial F_i}{\partial u_j} \geq 0, \quad i, j = 1, \dots, n, \quad i \neq j,$$

for all $u \in \mathbb{R}^n$. In this case the systems of equations (0.1) and (1.6) are called *monotone* systems. Such systems of equations are often encountered in applications (see §6 and Chapters 8 and 9).

The simplest particular case of such systems is the scalar equation ($n = 1$). If conditions (2.1) with strong inequalities are satisfied only on the surfaces $F_i(u) = 0$ ($i = 1, \dots, n$), the system of equations (0.1) is then said to be locally monotone (a generalization of this concept is given in §2 of Chapter 3).

As we have already remarked, for wave fronts we assume existence of the limits (1.8) and $F(w_{\pm}) = 0$. We seek monotone waves (for definiteness, monotonically decreasing) with the same direction of monotonicity for all components $w_i(x)$ of the vector $w(x)$. (Nonmonotone waves for monotone systems are unstable; see Chapter 5, §6.) Obviously, then, $w_+ < w_-$ and it is sufficient to require that inequality (2.1) be satisfied in the interval $[w_+, w_-]$, i.e., for $w_+ \leq w \leq w_-$.

We formulate a theorem for the existence of a wave in the case of a source of Type A.

THEOREM 2.1. *Let system (0.1) be monotone. Further, let the vector-valued function $F(u)$ vanish in a finite number of points u^k , $w_+ \leq u^k \leq w_-$ ($k = 1, \dots, m$). Let us assume that all the eigenvalues of the matrices $F'(w_+)$ and $F'(w_-)$ lie in the left half-plane, and that the matrices $F'(u^k)$ ($k = 1, \dots, m$) are irreducible and have at least one eigenvalue in the right half-plane. Then there exists a unique monotone traveling wave, i.e., a constant c and a twice continuously differentiable monotone vector-valued function $w(x)$ satisfying system (1.6) and the conditions (1.8).*

For Type B sources we have the following theorem for the existence of a wave.

THEOREM 2.2. *Let system (0.1) be monotone. Assume further that the vector-valued function $F(u)$ vanishes at a finite number of points u^k , $w_+ \leq u^k \leq w_-$ ($k = 1, \dots, m$). Suppose that all eigenvalues of the matrix $F'(w_-)$ lie in the left half-plane and that the matrices $F'(w_+)$, $F'(u^k)$ ($k = 1, \dots, m$) have eigenvalues in the right half-plane. There exists a positive constant c_* such that for all $c \geq c_*$ there exist monotone waves, i.e., solutions of system (1.6) satisfying conditions (1.8). When $c < c_*$, such waves do not exist. The constant c_* is determined with the aid of a minimax representation (see §4).*

Finally, we have the following result for Type C sources (where the system is not assumed to be monotone).

THEOREM 2.3. *Let the matrices $F'(w_+)$ and $F'(w_-)$ have eigenvalues in the right half-plane. Then a monotone wave does not exist, i.e., no monotone solution of system (1.6) exists satisfying conditions (1.8).*

For simplicity of exposition these theorems are stated here under conditions more stringent than necessary (see Chapter 3).

Theorem 2.1 is proved by the Leray-Schauder method and is generalized to a locally-monotone system (with no assertion regarding uniqueness of the wave). In Theorem 2.2 existence of solutions is first proved on a semi-axis $x \leq N$, and then we pass to the limit as N tends to infinity. The last theorem may be proved rather easily based on an analysis of the sign of the speed for a wave tending towards an unstable stationary point of system (1.11).

We remark that the existence and the number of waves for monotone systems is determined by the type of source. For a Type A source a wave exists for a unique value of the speed; for a Type B source it exists for speed values belonging to a half-axis; for a Type C source it does not exist.

This generalizes known results for a scalar equation (see Chapter 1), which are readily obtained from an analysis of trajectories in the phase plane. Moreover, Theorem 2.3 for a scalar equation is a consequence of a necessary condition for the existence of waves, a condition which may be formulated in the following way.

For the existence of a solution (c, w) of scalar equation (1.6) with conditions (1.8) and (1.9) it is necessary that one of the following inequalities be satisfied:

$$\int_{w_+}^w F(u) du < 0, \quad \int_w^{w_-} F(u) du > 0,$$

for all $w \in (w_+, w_-)$, where it is assumed that $w_+ < w_-$. For the case in which the first of these inequalities is satisfied, the speed $c \leq 0$; in the case of the second inequality, $c \geq 0$. Simultaneous satisfaction of both inequalities for all $w \in (w_+, w_-)$ is a necessary and sufficient condition for existence of a wave with zero speed.

A proof of this simple theorem is given in Chapter 1.

As examples we can consider sources shown in Figures 1.2–1.5. For the first three of these the necessary condition for existence is satisfied; for the fourth it is not satisfied and, consequently, the wave does not exist. As we shall see later, this necessary condition for existence of a wave is not a sufficient condition. For example, for a Type A source (Figure 1.6) it can be satisfied, while a wave with the limits (1.8), under certain conditions, does not exist. Instead of a wave there appears a system of waves. Sufficient conditions for the existence of waves for a scalar equation, which are not encompassed by Theorems 2.1 and 2.2, are discussed in Chapter 1.

Fairly detailed studies have been made of wave systems for a scalar equation. We introduce here the concept of a minimal system of waves, which describes the asymptotic behavior of solutions of a Cauchy problem and which, as will be shown later, exists for arbitrary sources.

§3. Stability of waves

3.1. Stability and spectrum. One of the most widely used methods for studying the stability of stationary solutions of nonlinear evolutionary systems is the method of infinitely small perturbations of a stationary solution. As a result of

linearizing nonlinear equations we arrive at the problem concerning the spectrum of a differential operator (call it L) and, therefore, a need to solve two problems: first, to find the structure of the spectrum of operator L ; second, what can be said concerning stability or instability of a stationary solution, knowing the spectrum structure. For the case in which the domain of variation of the spatial variables is bounded (and the system itself satisfies certain conditions, ordinarily met in applied problems), the spectrum of operator L is a discrete set of eigenvalues, and a stationary solution is stable if all the eigenvalues have negative real parts (i.e., lie in the left half of the complex plane) and unstable if at least one of them has a positive real part.

A substantially more involved situation arises when we consider stability of traveling waves. In this case, owing to the unboundedness of the domain of variation of the spatial variables, the spectrum of operator L includes not only discrete eigenvalues, but also a continuous spectrum. Moreover, operator L can have a zero eigenvalue (this is connected with invariance of a traveling wave with respect to translations). Nevertheless, it proves to be the case that a linear analysis allows us to make deductions, not only concerning stability or instability of a traveling wave, but also concerning the form of stability: in some problems we have ordinary asymptotic stability (with an exponential estimate for the decrease of perturbations), and in others we have stability with shift.

Stability with shift means that if the initial condition for a Cauchy problem for the system of equations

$$(3.1) \quad \frac{\partial u}{\partial t} = A \frac{\partial^2 u}{\partial x^2} + c \frac{\partial u}{\partial x} + F(u)$$

is close to a wave $w(x)$ in some norm, then the solution tends towards the wave $w(x+h)$ in this norm, where h is a number whose value depends on the choice of the initial conditions. Stability with shift arises because of the invariance of solutions with respect to translation and the presence of a zero eigenvalue. These questions are considered in Chapter 5, where a conditional theorem is proved concerning stability of traveling waves for the case in which the entire spectrum of the linearized problem, except for a simple zero eigenvalue, lies in the left half of the complex plane.

If operator L has eigenvalues in the right half-plane, the wave is unstable.

Let us suppose now that there are points of the continuous spectrum in the right half-plane. Such a situation is characteristic of the monostable case. A transition to weighted norms makes it possible to shift the continuous spectrum, something that was first done in [Sat 1,2]. If in a weighted space the continuous spectrum and eigenvalues lie in the left half-plane, the wave is then asymptotically stable with weight. Here stability can be both with shift and without shift, depending on whether the derivative $w'(x)$ belongs to the weighted space considered.

Thus, there arises a problem concerning the study of the spectrum of an operator linearized on a wave, which for one-dimensional waves, described by the system of equations (1.6), has the form

$$(3.2) \quad Lu = Au'' + cu' + F'(w(x))u,$$

where $w(x)$ is a wave. (In Chapter 4 these problems are studied in a somewhat more general setting.) Here we consider a question concerning structure of the

spectrum of this operator, being restricted to waves having limits at infinity (wave fronts, pulses):

$$w_{\pm} = \lim_{x \rightarrow \pm\infty} w(x).$$

The spectrum of operator L consists of a continuous spectrum and eigenvalues. The continuous spectrum is given by the equations

$$\det(-A\xi^2 + ic\xi + F'(w_{\pm}) - \lambda) = 0,$$

and is located in the half-plane $\operatorname{Re} \lambda \leq b$, where b is some number. It is obvious that if A is a scalar matrix, then the continuous spectrum is determined by the set of parabolas

$$(3.3) \quad -A\xi^2 + ic\xi + w_k^{\pm} - \lambda = 0,$$

where w_k^{\pm} are eigenvalues of the matrix $F'(w_{\pm})$ ($k = 1, \dots, n$). From (3.3) it is easy to see that if all the eigenvalues of the matrices $F'(w_{\pm})$ lie in the left half-plane, then the continuous spectrum also lies in the left half-plane. If these matrices have eigenvalues in the right half-plane, then there are also points of the continuous spectrum there. But if A is not a scalar matrix, it is then possible to have points of the continuous spectrum in the right half-plane even when all the eigenvalues of the matrix $F'(w_{\pm})$ lie in the left half-plane.

Besides a continuous spectrum, operator L has eigenvalues, also distributed in some half-plane $\operatorname{Re} \lambda \leq b_1$, with only a finite number of eigenvalues appearing in the right half-plane. It is easy to see that $\lambda = 0$ is an eigenvalue of operator L with eigenfunction $w'(x)$. Presence of a zero eigenvalue leads, as will become clear later, to certain peculiarities in the stability of waves.

Here we present briefly basic facts concerning the spectral distribution of an operator linearized on a wave and its connection with the stability of waves. It should be noted that if the distribution of the continuous spectrum can be obtained fairly simply, then determination of the eigenvalues, or conditions for their determination, in the left half-plane is coupled with great difficulties. Specific results are available for the study of individual classes of systems. A complete study has been made of the problem concerning stability of waves for monotone systems and for the scalar equation, in particular. These results are discussed in the following subsection.

Papers have appeared in which stability is proved, in the case of scalar equations, for waves propagating at large speeds [**Bel 1**]. These approaches readily carry over to certain classes of systems. In the monostable case, in which wave speeds can occupy an entire half-axis, this yields stability of waves for speeds larger than some value. In the bistable case the speed of a wave, only in individual cases, satisfies the conditions imposed on it connected with properties of the matrix F' .

Yet another approach to the study of the stability of waves is based on asymptotic methods. The methods most developed, apparently, are those in combustion theory [**Zel 5**]. For many combustion problems presence of a small parameter is typical; this makes it possible to find, approximately, both a stationary wave and the boundary of its stability in parametric domains (see the supplement to Part III). We remark that the propagation of waves of combustion of gases, under specified conditions, is described by monotone systems. This makes it possible to apply the theory, developed for such systems, to the description of these processes

(see Chapters 8 and 9). In some cases combustion problems are considered as free boundary problems (see [Brau 2, Hil 3] and references there).

There are also a number of papers in which a study is made of the stability of wave fronts [Nis 1], pulses [Eva 2–4, 6, Fer 3, Fife 3, Lar 1, Wan 2], and periodic waves [Barr 2, Erm 1, Kern 1, Mag 1–4, Rau 1, Yan 3] in various model systems (see also [Bark 1, Jon 3, Kla 1, Kole 1, 2, Mat 7, Pelc 1, Col 1, Gard 9, Nis 2]).

A topological invariant characterizing stability of traveling waves is presented in [Ale 2]. In [Gard 7] this approach is used to analyze stability in a predator-prey system. Structure of the spectrum of an operator, linearized on periodic waves, is studied in [Gard 8]. The stability of waves, described by a parabolic equation of higher order, is presented in [Gard 6]. Analysis of the stability of traveling waves for scalar viscous conservation laws appears in [Jon 4] and [Goo 1, 2].

Along with the problem of stability of waves, there is the closely related problem of the approach to a wave solution of a Cauchy problem with initial conditions “far” from the wave. We distinguish three types of approach to a wave. By a uniform approach we mean convergence, as $t \rightarrow \infty$,

$$(3.4) \quad u(x + ct, t) \rightarrow w(x + h),$$

of a solution of the Cauchy problem to a stationary wave, shifted with respect to x , uniformly with respect to x over the whole axis or on each finite interval. Uniform approach to a wave implies a second type of approach, namely, approach in form, i.e.,

$$(3.5) \quad u(x + m(t), t) \rightarrow w(x),$$

uniformly with respect to x . Here $m(t)$ is the coordinate of a characteristic point, for example, given by the equation

$$(3.6) \quad u_1(m(t), t) = w_1(0)$$

(u_1 and w_1 are the first components of the corresponding vectors). Thus, form approach means that a solution is always moved so that the value of its first component at $x = 0$ will coincide with that for the first component of the wave, and then a profile of the solution approaches, in time, a profile of the wave. Approach in form implies a third type of convergence, namely, approach in speed:

$$(3.7) \quad m'(t) \rightarrow c \quad (t \rightarrow \infty).$$

Generally speaking, approach in form does not imply uniform approach to a wave. This is, in fact, one of the results presented in [Kolm 1]: under specific initial conditions a solution can approach a wave in form and speed, but lag behind any one of the waves (recall that waves are determined up to translation). It was shown in subsequent papers [Uch 2] that this is the case

$$(3.8) \quad m(t) \approx ct - c_1 \ln t,$$

where c_1 is a constant. Approach of solutions to a wave has been thoroughly investigated for the scalar equation and, to some degree, for monotone systems. For other cases what is known, as a rule, is only that obtained through numerical modeling.

One cannot define a concept of stability to small perturbations for a system of waves, at least in the ordinary sense, since a system of waves is not a stationary

solution. However, as is also the case for waves, we can use the concept of an approach to a system of waves. If for each of the waves comprising a system of waves we specify a function $m(t)$ by equation (3.6), we must then have the convergence relations (3.5) and (3.7). In other words, if we select moving coordinates connected with one of the waves of the system of waves, then in these coordinates the solution must converge to this wave uniformly on each finite interval. As shown for a scalar equation (see Chapter 1 and [Fife 7]) and obtained numerically, and approximately by analytical methods, such convergence actually occurs in combustion theory (see Chapter 9).

3.2. Stability of waves for monotone systems. Comparison theorems hold for monotone systems and, in particular, for the scalar equation: from the inequality, for the initial conditions,

$$u(x, 0) \geq v(x, 0) \quad (-\infty < x < \infty),$$

we have the inequality

$$u(x, t) \geq v(x, t) \quad (-\infty < x < \infty),$$

for solutions of the Cauchy problem. This property of monotone systems determines, in many cases, the properties of waves, including stability of monotone waves (non-monotone waves are unstable). It is easily shown that small finite perturbations of monotone waves do not increase. Actually, if $w(x)$ is a wave, and $\varepsilon(x)$ is a small function with a finite support, small numbers h_1 and h_2 can be found such that

$$w(x + h_1) \leq w(x) + \varepsilon(x) \leq w(x + h_2).$$

Therefore, for a solution $u(x, t)$ of system (3.1), with the initial condition $u(x, 0) = w(x) + \varepsilon(x)$, we have also the analogous inequality

$$w(x + h_1) \leq u(x, t) \leq w(x + h_2),$$

i.e., perturbations of the wave remain small.

The proof of asymptotic stability of waves for monotone systems is somewhat more involved. This material is presented in detail in Chapter 5. Here we dwell briefly on the basic idea of this proof. For matrices with nonnegative off-diagonal elements there is the well-known Perron-Frobenius Theorem, which says that to the eigenvalue with largest real part there corresponds a nonnegative eigenvector and, for irreducible matrices, there are no other nonnegative eigenvectors. Similar properties are also possessed by differential operators of the form

$$(3.9) \quad Mu \equiv au'' + bu' + cu,$$

where a , b , c are functional matrices, a , b are diagonal matrices, a has positive diagonal elements, and c has nonnegative off-diagonal elements. It proves to be the case, in particular, that if $\lambda = 0$ is an eigenvalue of operator M to which there corresponds a positive eigenfunction, then all the remaining eigenvalues of this operator lie in the left half-plane. It is of interest to note that there is a condition for operators (3.9) analogous to the condition for irreducibility of matrix c (there are works devoted to spectral properties of positive operators close to those considered here (see [Kra 1]); however, it has not been possible to apply the results to the case in question; for waves, presence of positive eigenfunctions in the study

of the spectral distribution was first made use of in [**Baren 2**] in the study of a scalar equation).

It has already been noted above that operator L defined by equation (3.2) and arising in the linearization of the system of equations (1.6) on a wave has a zero eigenvalue to which there corresponds the eigenfunction $w'(x)$. In view of the above, this means that for monotone waves all the eigenvalues of the linearized operator, except for a simple eigenvalue $\lambda = 0$, lie in the left half-plane. In the bistable case for which the continuous spectrum also lies in the left half-plane, this leads to stability of waves in the uniform norm; when there are points of the continuous spectrum in the right half-plane stability of waves in weighted norms obtains.

Besides stability of waves to small perturbations, for monotone systems we have stability of monotone waves in the large. More precisely, if we have stability of a wave with shift (in the bistable case, in particular), then for an arbitrary monotone initial condition, tending towards w_{\pm} as $x \rightarrow \pm\infty$, the solution approaches the wave.

For a scalar equation results concerning the stability of waves are practically the same as for monotone systems. However, approaches to a wave and systems of waves were studied in this case essentially in greater detail. This is connected, to a large degree, with use of the method, taking its name from [**Kolm 1**] and developed further in other papers, which cannot be used for systems of equations. This method amounts to the application of comparison theorems in the phase plane (see Chapter 1).

The simplest version of comparison theorems in the phase plane can be formulated as follows. Let $u_1(x, t)$ and $u_2(x, t)$ be solutions of a Cauchy problem for equation (3.1) with initial conditions $u_i(x, 0) = f_i(x)$, where $f_i(x)$ are smooth monotonically decreasing functions. We introduce the functions $p_i(t, u) = u'_i(x, t)$, where $u = u'_i(x, t)$. That is, the functions p_i establish a correspondence between a value of solution u_i , for some x and t , and the value of the derivative of the solution. Since u_i are monotone functions, the p_i are defined and single-valued. If for initial conditions we have the inequality $p_1(0, u) \leq p_2(0, u)$ for all those u for which both of these functions are defined, the analogous inequality $p_1(t, u) \leq p_2(t, u)$, $t \geq 0$, also holds for solutions (also for those values of u for which both functions are defined).

Theorems of this kind permit various generalizations to nonsmooth, and even to discontinuous, functions, to nonmonotone functions, etc. They make it possible to prove convergence of the function $p(t, u)$ to a function $R(u)$, corresponding to a wave or to a system of waves. We illustrate this with a simple example. As the initial condition we take a function equal to w_- for $x < 0$ and to w_+ for $x > 0$. It is easy to verify that in this case the function $p(t, u)$ is monotonically increasing with respect to t for each fixed u , and it remains nonpositive. Its limit as $t \rightarrow \infty$ is either a wave (in the monostable case a wave with minimal speed) or a minimal system of waves if waves joining points w_+ and w_- do not exist.

The approach connected with comparison theorems in the phase plane allows us to study the asymptotic behavior of solutions of a Cauchy problem for arbitrary sources $F(u)$. There are, along with this, also other methods for proving stability of waves and approach to a wave for a scalar equation (see the supplement to Chapter 1); these problems have been rather well studied. Nevertheless, some questions still remain here, including the problem of obtaining necessary and sufficient conditions for the approach to a wave for a possibly broader class of initial conditions (for a positive source, under certain additional restrictions, this

problem can be regarded as solved [**Bra 1, Lua 1**]). Many problems arise in going over to nonlinear equations of a more general form (see Chapter 1).

§4. Wave propagation speed

The speed of a wave is one of its basic characteristics, and there exists a large number of papers devoted to determining the speed of propagation in various applied problems and model systems. As an example, we can cite the simplest model for propagation of a combustion front, to which no less than ten papers were devoted to determination of its speed (see the supplement to Part III). Here, in the main, various approximations were applied, both analytical and asymptotic methods, using a presence in the problem of a small parameter and a priori physical considerations.

Such attention, directed to the simplest model, is completely understandable: it is associated with the desire to complete the approximate methods and to verify physical approaches. On the other hand, it expresses the fact that there were few methods for determining the speed, which were of a general nature and mathematically rigorous. Here, of course, we do not have in mind the case of a scalar equation, where, for example, for a Type B source (see §1), with an unstable stationary point w_+ satisfying the conditions

$$\begin{aligned} F(u) &> 0 & (w_+ < u < w_-), \\ F'(w_+) &\geq F'(u) & (w_+ \leq u \leq w_-) \end{aligned}$$

(see [**Kolm 1**]), it is known that waves exist for all speeds $c \geq c_*$, where $c_* = 2(F'(w_+))^{1/2}$.

For scalar equations one of the principal approaches for determining the speed is the minimax method, in which the speed of a wave is represented as a maximum and minimum of certain functionals. This method is presented below (see Chapter 1); it is generalizable to the case of monotone systems, introduced in §2.2 (Chapter 5).

A minimax representation of the speed for a scalar equation was first obtained in [**Had 2, Ros 1, 2**], where it was used to obtain estimates of the speed. A successful use of the minimax representation was also made to qualitatively analyze the behavior of solutions (see Chapter 1). It is of interest to note that for a scalar equation a minimax representation can be obtained in two ways: through determination of an eigenvalue of a selfadjoint operator corresponding to a second order equation, and on the basis of an analysis of the behavior of the trajectories of a system of first order equations. However, for monotone systems, analogous in many ways to a scalar equation, neither of these methods has been applied successfully. This representation was obtained by another method.

The main result on the minimax representation for the speed of a wave for monotone systems consists in the following: Let c be the speed of a monotone wave for system (1.1) of Type A (see §1.1). We then have the representation

$$(4.1) \quad c = \min_{\rho} \max_{x,i} B_i(\rho) = \max_{\rho} \min_{x,i} B_i(\rho),$$

where

$$B_i(\rho) = -\frac{\rho_i''(x) + F_i(\rho)}{\rho_i'(x)} \quad (i = 1, \dots, n),$$

$\rho(x) = (\rho_1(x), \dots, \rho_n(x))$ is a monotonically decreasing twice continuously differentiable function tending towards w_{\pm} for $x \rightarrow \pm\infty$. It is easy to see that if we substitute a wave as the test function ρ , we then obtain $B_i \equiv c$.

For a system (1.1) of Type B the first of the representations in (4.1) gives the minimal speed value (assuming, for definiteness, that it is positive), while the second representation estimates an upper limit to the speeds for which a wave exists. In particular, if there are no other stationary points in the interval $[w_+, w_-]$ except w_{\pm} , then waves exist for all $c \geq c_*$. If we restrict in a specific way the class of functions $\rho(x)$ (see Chapter 5), then the second representation in (4.1) also yields a minimal speed value.

It is evident from (4.1) that with an increase in function F the wave speed increases. This statement may be verified directly for monotone systems. However, for other types of systems of equations this may not hold as well as the minimax representation. A problem of some interest concerns the description of a class of systems for which minimax representations are valid.

A second approach, mentioned above, to obtaining minimax representations, namely, an analysis of the behavior of trajectories in the phase plane, can also be generalized to systems of equations. In Chapter 10 this is done for a model system, arising in combustion theory, which may also be reduced to a system of two first order equations. This approach is no longer connected with monotonicity of the system; its availability for systems of much higher order would be most desirable.

The minimax representation makes it possible to obtain two-sided estimates of the speed, the accuracy for which depends on the choice of a test function. In Chapter 10 possibilities of the method are illustrated by way of some problems from combustion theory. In connection with these problems it has been possible in a number of cases to obtain good estimates when the difference of upper and lower estimates for typical ranges of variation of the parameter amounts to several percent. In addition it has been possible to obtain the asymptotics of the speed with respect to a small parameter pertinent to the problem.

Yet another method for determining the speed of propagation of a wave, namely, the method of successive approximations, is developed in Chapter 10, also by way of an example from combustion theory.

§5. Bifurcations of waves

The theory of bifurcations furnishes a very convenient apparatus for studying the form, existence, and stability of multi-dimensional waves arising as a result of the loss of stability of a planar wave. Bifurcations of waves studied here are close to Hopf bifurcations (see, e.g., [Mars 1]); they do, however, have their own specific character: first, planar waves are not isolated stationary solutions, and, second, the linearized system has a zero eigenvalue, which, in contrast to other eigenvalues on the imaginary axis, does not contribute to the birth of new modes.

5.1. Statement of the problem. We consider the system (0.1) on the assumption that the vector-valued function $F(u)$ depends on a real parameter μ , and, in keeping with this, we write $F(u, \mu)$ instead of $F(u)$. We assume, for all values of the parameter μ considered, that a planar wave w_{μ} exists. We shall study solutions of system (0.1) of traveling wave type, branching from a planar wave during passage of the parameter through some value μ_0 . Speed c of the wave is also to be determined. We seek a solution of system (0.1) which, in

a system of coordinates connected with the front of the wave being studied, is periodic in time. Such periodic waves have already been described in §1, where it was shown that they include various wave propagation modes encountered in the applications, in particular, spinning waves, symmetric waves, one-dimensional waves, auto-oscillations, etc.

It is convenient to select a time scale so that the modes have period 2π . With this in mind, we make the substitution $\tau = \omega t$ (we assume that in the initial coordinates the period of a wave is equal to $2\pi/\omega$, where ω is a quantity to be determined). Having made the indicated substitution and changing over in (0.1) to coordinates connected with the wave front, we obtain the following system of equations:

$$(5.1) \quad \omega \frac{\partial u}{\partial \tau} = A\Delta u + c \frac{\partial u}{\partial x_1} + F(u, \mu), \quad \left. \frac{\partial u}{\partial \nu} \right|_S = 0.$$

Thus, we need to clarify the existence of a solution of system (5.1) with a period 2π with respect to the time, and also to study its form and stability for cylinders Ω of various cross-sections.

5.2. Conditions for the occurrence of bifurcations. We linearize system (5.1) on a planar wave w and consider a corresponding stationary eigenvalue problem

$$(5.2) \quad A\Delta v + c \frac{\partial v}{\partial x_1} + B_\mu v = \lambda v, \quad \left. \frac{\partial v}{\partial \nu} \right|_S = 0,$$

where $B_\mu = F'(w(x), \mu)$. The bifurcations of interest to us take place when, with a change in the parameter μ , the eigenvalues of problem (5.2) pass through the imaginary axis, i.e., for $\mu = \mu_0$ eigenvalues λ are found on the imaginary axis. We limit our discussion to the case in which this is an eigenvalue different from zero and, in addition, there is only one pair of complex conjugate eigenvalues, not excluding a possible multiplicity, on the imaginary axis. Thus the bifurcations in question are close to the known Hopf bifurcations, but differ from them by a possible multiplicity of the eigenvalues and also by the specific character indicated above.

In studying conditions for the emergence of bifurcations, i.e., for a passage of eigenvalues through the imaginary axis, we pass from system (5.2) to its Fourier transform, having in mind an expansion in Fourier series of eigenfunctions of the problem

$$(5.3) \quad \Delta g + sg = 0, \quad \left. \frac{\partial g}{\partial \nu} \right|_\gamma = 0,$$

considered in the cross-section G of cylinder Ω . Here γ is the boundary of G and Δ is an $(n-1)$ -dimensional Laplace operator in the coordinates x_2, \dots, x_n . Equations for the coefficients $\theta(x_1)$ of this expansion have the form

$$(5.4) \quad L_{s\mu}\theta \equiv A\theta'' - sA\theta + c\theta' + B_\mu\theta = \lambda\theta,$$

where s runs through the eigenvalues of problem (5.3): $s_0 = 0, s_1, s_2, \dots$. It is easy to see that the eigenvalues λ of problem (5.2) coincide with the set of eigenvalues of

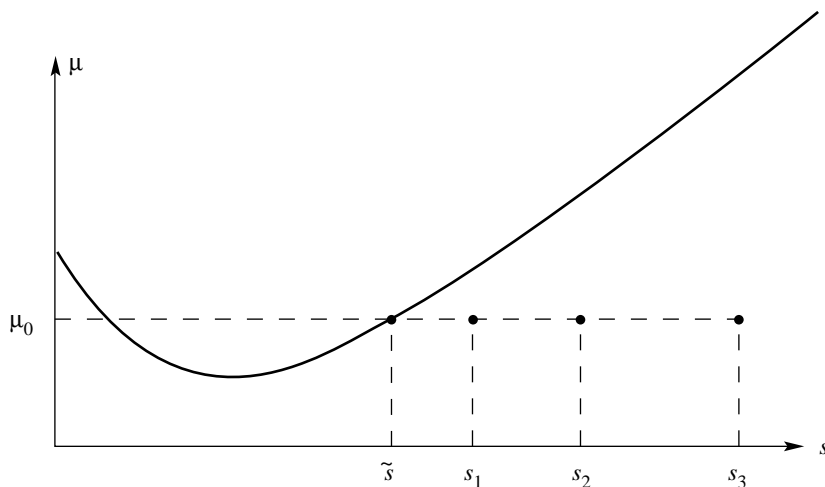

FIGURE 5.1. A sketch of the stability diagram

problem (5.4) for $s = s_k$ ($k = 0, 1, 2, \dots$). Moreover, eigenfunctions of problem (5.2), corresponding to the value λ considered, have the form

$$(5.5) \quad \theta(x_1)g^k(x') \quad (k = 1, \dots, l),$$

where $x' = (x_2, \dots, x_n)$, $\theta(x_1)$ is the eigenfunction of problem (5.4) corresponding to the eigenvalue λ , l is the multiplicity of the eigenvalue s of problem (5.3), and g^1, \dots, g^l are the corresponding eigenfunctions, which we consider orthonormalized.

It is obvious that the eigenvalues λ determined from (5.4) are functions of the parameters s and μ : $\lambda = \lambda(s, \mu)$. In the half-plane (s, μ) , $s > 0$, we consider a set of points Γ such that operator $L_{s\mu}$ has purely imaginary eigenvalues for these s and μ , and has no eigenvalues in the right half-plane (see Figure 5.1). We assume, for definiteness, that for (s, μ) lying below the curve Γ , all eigenvalues $\lambda(s, \mu)$ of operator $L_{s\mu}$ lie in the left half-plane, and for (s, μ) , lying above Γ , an eigenvalue is found in the right half-plane. We assume also that Γ is the graph of a single-valued function $\mu = \mu(s)$, having a minimum at some point $s > 0$. Such a disposition of curve Γ has been observed in various physical and biological models, in particular, in combustion (see [Zel 5]).

Let \tilde{s} denote the abscissa of the farthest right point of intersection of curve Γ with the line $\mu = \mu_0$. Then for $s = \tilde{s}$ and $\mu < \mu_0$ all the eigenvalues $\lambda(\tilde{s}, \mu)$ of the operator $L_{\tilde{s}\mu}$ lie in the left half-plane; for $\mu > \mu_0$ there are eigenvalues $\lambda(\tilde{s}, \mu)$ in the right half-plane and $\lambda(\tilde{s}, \mu_0)$ is purely imaginary. Let $\lambda(\tilde{s}, \mu_0) = i\alpha$, and let us assume that this is a simple eigenvalue.

In order to trace how successive bifurcations take place, it is convenient to introduce into the problem in question yet another parameter (for example, the radius, in the case of a circular cylinder, or some other characteristic dimension of the domain in a cross-section of the cylinder). Let us denote this parameter by R . The eigenvalue s of problem (5.3) will be functions of this parameter, which we assume to be monotonically decreasing and tending towards zero as R increases. In the case of a circular cylinder, for example, these functions are of this kind (see (5.10)). Obviously, for R sufficiently small we have the inequalities $s_k > \tilde{s}$ ($k = 1, 2, \dots$). We now let R increase. We can then find a value $R = R_1$ for which $s_1 = \tilde{s}$, and, consequently, $\lambda(s_1, \mu_0) = i\alpha$. Here a bifurcation takes place, the nature of which we describe below. With further increase R takes on the value $R = R_2$,

for which $s_2 = \tilde{s}$, so that $\lambda(s_2, \mu_0) = i\mathcal{N}$. The next bifurcation then occurs, and so forth.

Figure 5.1 depicts the case for R sufficiently small.

5.3. A study of bifurcating waves. In place of μ we introduce the parameter ε , equal to the norm of the deviation of the sought-for solution u from the planar wave w . We then have the following expansion in powers of the small parameter ε :

$$(5.6) \quad \begin{aligned} u &= w + \varepsilon y_1 + \varepsilon^2 y_2 + \cdots, & c &= \tilde{c} + \varepsilon^2 c_2 + \cdots, \\ \mu &= \mu_0 + \varepsilon^2 \mu_2 + \cdots, & \omega &= \omega_0 + \varepsilon^2 \omega_2 + \cdots, \end{aligned}$$

coefficients of which can be determined sequentially. Moreover, it may be shown that y_1 is a solution of the linearized problem and has the form

$$(5.7) \quad y_1 = \sum_{k=1}^l \operatorname{Re}[\alpha_k \theta(x_1) g^k(x') \exp(i\tau)],$$

where $\theta(x_1)g^k(x')$ are the eigenfunctions of problem (5.2) for $\lambda = i\mathcal{N}$, $\mu = \mu_0$, and α_k are complex constants,

$$(5.8) \quad \sum_{k=1}^l |\alpha_k|^2 = 1.$$

Constants α_k are determined from a third step of expansion (5.6) by solving a system of algebraic equations obtained from conditions for solvability of the nonhomogeneous linearized system: orthogonality of the right-hand sides to the solutions of the adjoint problem. Such a determination is necessary only in the case of multiple eigenvalues ($l > 1$). For $l = 1$ we can assume that $\alpha_1 = 1$. We remark that, in spite of the complexity of the systems of equations obtained for determining the α_k , in all cases in which studies have been made the answer turned out to be very simple. Thus, for example, for a circular cylinder with $l = 2$, the α_k have one of the following forms in the generic case:

$$(5.9) \quad \begin{aligned} 1) & \quad |\alpha_1| = 1, \quad \alpha_2 = 0, \\ 2) & \quad |\alpha_2| = 1, \quad \alpha_1 = 0, \\ 3) & \quad |\alpha_1| = |\alpha_2| = 2^{-1/2}. \end{aligned}$$

By means of the expansion (5.6) we also prove the existence of bifurcating waves, where the word ‘‘bifurcating’’ bears a conditional character. Actually, it follows from (5.6) that $\mu > \mu_0$ if $\mu_2 > 0$, and that $\mu < \mu_0$ if $\mu_2 < 0$. Both cases are possible. In the first of these the birth of waves actually takes place during passage of μ through the critical value μ_0 (we assume that as μ moves it increases). Such bifurcations are called supercritical. In the other case the waves in question coexist with a stable planar wave w and, during passage of μ through a critical value, they disappear. We call such bifurcations subcritical.

Stability may also be studied by means of expansions with respect to a small parameter. It turns out that in the case of a simple eigenvalue ($l = 1$) subcritical bifurcations are unstable and supercritical bifurcations are stable. In the case of multiple eigenvalues ($l > 1$) unstable supercritical bifurcations are also possible.

We illustrate the above with examples from frequently encountered cases: a circular cylinder; a strip; a cylindrical domain with square cross-section.

Circular cylinder. In this case the eigenvalues s and eigenfunctions g of problem (5.3) have the form

$$(5.10) \quad s = \sigma_{mk}^2/R^2, \quad g = J_m(r\sigma_{mk}/R) \exp(\pm im\varphi) \quad (m, k = 0, 1, 2, \dots).$$

Here J_m is a Bessel function of order m ; σ_{mk} are the consecutive zeros of its derivative; R is the radius of the circle; and r and φ are polar coordinates.

When $m = 0$ the eigenvalues are simple and equation (5.7) takes the form

$$(5.11) \quad y_1 = \operatorname{Re}[\theta(x_1) \exp(i\tau)] J_0(r\sigma_{0k}/R).$$

For $m > 0$ the eigenvalues of problem (5.3) are double. As was remarked above, the α_k in this case are given by equations (5.9). To begin, we consider the first of these equations. Setting $\alpha_1 = \exp(is_1)$, where s_1 is a real parameter, we obtain

$$(5.12) \quad y_1 = \operatorname{Re}[\theta(x_1) \exp i(\pm m\varphi + \tau + s_1)] J_m(r\sigma_{mk}/R),$$

where we take the $+$ sign for $m\varphi$. For the second of the equations (5.9) the result is similar: y_1 is given by equation (5.12) with the $-$ sign for $m\varphi$.

In the case of the third of equations (5.9) it is convenient to set $\alpha_j = 2^{-1/2} \exp(is_j)$ ($j = 1, 2$), where s_j are arbitrary real constants. Introducing new arbitrary constants φ_0 and τ_0 : $s_1 = k\varphi_0 + \tau_0$, $s_2 = -k\varphi_0 + \tau_0$, we obtain

$$(5.13) \quad y_1 = \operatorname{Re}[\theta(x_1) \exp i(\tau + \tau_0)] J_m(r\sigma_{mk}/R) \cos m(\varphi + \varphi_0)$$

(positive constant factors in y_1 have been omitted).

Equations (5.11)–(5.13) include all modes of wave propagation present in a circular cylinder for the bifurcations considered. More precisely, we have indicated the leading terms in the expansions in powers of the small parameter ε for all these modes. In this way, we see that the leading terms of the expansion are written out explicitly with respect to the transverse variables, and we can describe the waves considered by these leading terms. This is conveniently done by tracing the motion of an arbitrary characteristic point. As such points we can take the maxima of a component of vector y_1 . In combustion this corresponds to what is observed experimentally: the motion of luminous spots, of which we spoke in §1, namely, points of maximum temperature. Naturally, higher order terms in expansion (5.6) can also contribute, but this does not change the character of the mode considered. This is confirmed by the good agreement of the waves described in this way with experimental observations.

We shall describe bifurcations in the order in which they arise as the cylinder radius R increases, in accordance with the description given in the preceding section. This order is determined by the sequence of eigenvalues of problem (5.3), taken in increasing order. By virtue of (5.10) this is determined by the description of the zeros of the derivatives of the Bessel functions. Figure 5.2 shows graphs of Bessel functions of orders $m = 0, 1, 2, 3$ and zeros of their derivatives. For $m > 3$ positive zeros of the derivatives are found to the right. It is evident from this figure that the positive zeros of the derivatives are located in such a sequence,

$$(5.14) \quad \sigma_{11}, \sigma_{21}, \sigma_{01}, \sigma_{31}, \sigma_{12}, \dots$$

We consider the equality

$$(5.15) \quad s_j = \tilde{s} \quad (j = 1, 2, \dots),$$

where the s_j are consecutive positive eigenvalues of problem (5.3), and \tilde{s} is the

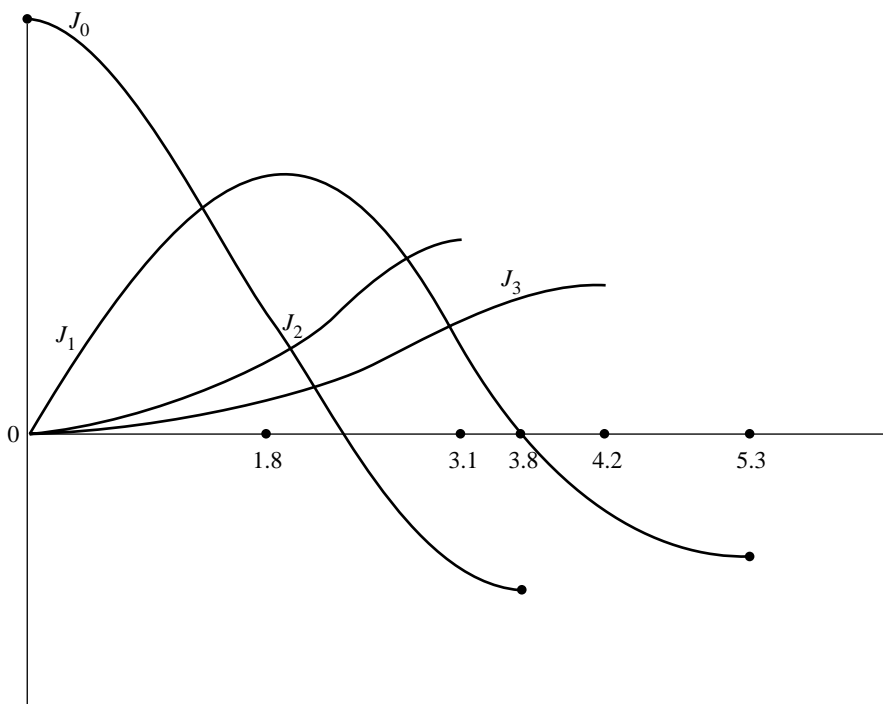

FIGURE 5.2. A sketch of Bessel functions of orders 0,1,2,3

abscissa of the right-most point of intersection of curve Γ with the line $\mu = \mu_0$ (see Figure 5.1). On the basis of (5.10) and (5.15) we have the following expression for the critical values R_j of radius R , i.e., values of R , in passage through which with increasing R , bifurcations occur:

$$(5.16) \quad R_j = \sigma_{mk}(\tilde{s})^{-1/2}.$$

Here the ordering of the R_j corresponds to the ordering of the zeros of the derivatives of the Bessel functions, so that on the basis of (5.14)

$$(5.17) \quad R_1 = \varkappa\sigma_{11}, \quad R_2 = \varkappa\sigma_{21}, \quad R_3 = \varkappa\sigma_{02}, \quad R_4 = \varkappa\sigma_{31}, \quad R_5 = \varkappa\sigma_{12}, \dots,$$

where $\varkappa = (\tilde{s})^{-1/2}$ is a constant if μ_0 is fixed, which we assume. Approximate values of the R_j indicated are as follows (see Figure 5.2):

$$(5.18) \quad R_1 = 1.8\varkappa, \quad R_2 = 3.1\varkappa, \quad R_3 = 3.8\varkappa, \quad R_4 = 4.2\varkappa, \quad R_5 = 5.3\varkappa.$$

We begin with bifurcations which occur when R passes through the value R_1 . By virtue of (5.17) this corresponds to the first zero σ_{11} of the derivative of the first Bessel function J_1 . The expression for the leading term y_1 in expansion (5.6) for solution u in powers of a small parameter is given by equations (5.12) and (5.13) for $m = 1, k = 1$. This means that three modes arise. The first two are described by equation (5.12) with the + and - signs taken into account; the third mode is described by equation (5.13).

We begin with the mode defined by equation (5.12) for $m = 1, k = 1$ and with the + sign in the exponent. As already noted, we are considering a cylinder of

radius R_1 . Dependence of function y_1 on R is specified by the factor $J(r\sigma_{11}/R_1)$, which increases with r and achieves a maximum for $r = R_1$, i.e., on the surface of the cylinder (see Figure 5.2). We now find the maximum of the first factor in equation (5.12). For definiteness, we consider the first component y_{11} of the vector-valued function y_1 , and let $\theta_1(x_1)$ be the first component of the vector-valued function $\theta(x_1)$. Then

$$(5.19) \quad y_{11} = |\theta_1(x_1)| \cos[\psi(x_1) + \varphi + \tau + s_1] J_1(r\sigma_{11}/R_1),$$

where $\psi(x_1)$ is the argument of function $\theta(x_1)$. Let \bar{x}_1 be a point in which function $|\theta_1(x_1)|$ attains a maximum. Then, obviously, a maximum of function y_{11} is attained for

$$x_1 = \bar{x}_1, \quad r = R_1, \quad \varphi = -s_1 - \psi(x_1) - \tau.$$

Consequently, the maximum of y_{11} moves uniformly with respect to time along a circle on the surface of cylinder Ω in a plane orthogonal to the axis of the cylinder. A similar conclusion can be made also for the remaining elements of the vector-valued function y_1 .

Recall now that we are considering system (5.1), written in coordinates connected with a wavefront, i.e., in coordinates in which the front of the wave is fixed. In the initial coordinates the wave moves along the axis of the cylinder with constant speed c . Thus, maxima of the elements of the vector-valued function y_1 move along the surface of cylinder Ω with constant angular rate with respect to angle φ and along the axis x_1 of the cylinder, i.e., along a spiral on the cylinder surface. We have already described such modes of wave propagation in §1, where we called them spinning modes. The characteristic form of such waves is shown in Figure 1.10.

We turn our attention to the fact that equation (5.12) includes two modes in accordance with the \pm signs in the exponent. The mode just described corresponds to the $+$ sign. It is clear that the mode corresponding to the minus sign is also a spinning mode with opposite direction of revolution around the cylinder axis.

REMARK. We obtained spinning waves using only the first term y_1 of expansion (5.6). The question arises as to how the following terms of the expansion manifest themselves. We can show that a mode turns out to be a spinning mode, i.e., motion of maxima occurs along a spiral on the cylinder surface, even if all the terms of the expansion are taken into account simultaneously.

It remains now to analyze the third of the modes that arise; the leading term of this mode is given by equation (5.13) with $m = k = 1$. As was the case above, we observe that the maxima of elements of the vector-valued function y_1 are found on the surface of the cylinder. In order to trace the motion of these maxima we consider, as before, for definiteness, the first component of the vector-valued function y_1 , and we obtain

$$(5.20) \quad y_{11} = |\theta_1(x_1)| \cos[\psi(x_1) + \tau + \tau_0] \cos(\varphi + \varphi_0) J_1(r\sigma_{11}/R_1).$$

It is evident from this equation that a maximum stays fixed in the course of a half-period on the cylinder surface, then instantly jumps over onto the opposite side of the cylinder surface, stays there in the course of a half-period, and so forth. Such behavior of a maximum is the result of considering only the leading term of expansion (5.6). It is easy to see that one cannot always describe the behavior of the maxima by only the leading term. Indeed, the leading term y_1 vanishes at the

ends of the half-periods considered; this follows from the expression (5.20). Close to these values of the time, when y_1 is of order ε , the first term of expansion (5.6) is comparable with the second; therefore, we must take into account their sum, which, generally speaking, smooths out any discontinuity in the position of the maxima. If we take into account motion with constant speed along the x_1 -axis, we find that motion of the maxima has the form shown in Figure 1.12. Thus the third of the modes considered turns out to be a symmetric mode, as pointed out in §1.

Thus, we have considered the first bifurcation, which occurs when R passes through the value R_1 . The second bifurcation for $R = R_2$ also has a completely analogous character. Indeed, by virtue of (5.14) we are concerned with the first zero of the derivative of a Bessel function of the second order, i.e., the leading term of the expansion in (5.6) has the form (5.12) and (5.13) for $R = R_2$, $m = 2$, $k = 1$. It is easy to see that in this case the maxima of the components of the vector-valued function y_1 lie on the cylinder surface. The difference from the previous case is that two maxima appear on the surface at once, i.e., our concern is with two-spot spinning and symmetric modes. These have also been observed experimentally and were pointed out in §1 (see Figures 1.11 and 1.14).

The third bifurcation (for $R = R_3$) is of a completely different character. By virtue of (5.14), here we must consider a second zero of the derivative of a Bessel function of order zero, so that y_1 is given by equation (5.11) with $R = R_3$, $k = 2$. The function $J_0(r\sigma_{02}/R_3)$ has a maximum on the interval $[0, R_3]$ at the point $r = 0$ and a minimum at the point $r = R_3$ (see Figure 5.2). If now we follow the maxima of elements of the vector-valued function y_1 , it is then easy to see that in the course of a half-period they are found at the point $r = 0$, then instantly jump over to the point $r = R_3$, stay there in the course of a half-period, etc. Since y_1 does not depend on φ , then, in the course of the second of the indicated half-periods points of the maxima fill-out a complete circle on the cylinder surface. Here we have the same situation as in the symmetric mode, when, close to the ends of the indicated half-periods, account must be taken of the contribution of the higher order terms of the expansion (5.6). Taking into account motion along the x_1 -axis, we obtain the mode described in §1.2.5 and observed experimentally in combustion (Figure 1.15).

The fourth bifurcation, according to (5.14), is connected with the first zero of the derivative of a Bessel function of the third order and leads to three-spot spinning and symmetric modes. The next bifurcation is connected with the second zero of the derivative of a Bessel function of the first order and leads to one-spot spinning and symmetric modes, but, in contrast to the first bifurcation, the spots are not located on the cylinder surface.

All further bifurcations are described in the same way, and we arrive at the following result. All the bifurcations connected with positive eigenvalues s of problem (5.3) are described by the leading term of the expansion (5.11), (5.13) and lead to three modes: spinning and symmetric modes (for $m > 0$) and a radial mode (for $m = 0$). Spinning and symmetric modes coexist and have m hot spots. Here m is the order of the Bessel function.

We shall not present results relating to stability here, but refer the reader to Chapter 6. We merely note that if a spinning mode is stable, then the symmetric mode is unstable and, conversely, if the symmetric mode is stable, then the spinning mode is unstable. This explains the fact that, in experiments dealing with combustion, if a spinning mode is observed, no symmetric mode is observed.

The results presented here show how well waves observed experimentally can

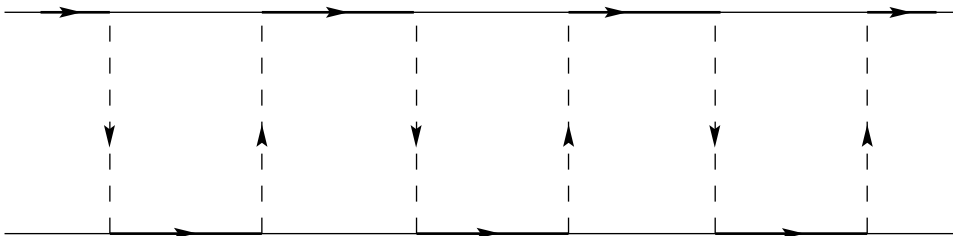

FIGURE 5.3. One-spot mode of wave propagation in a strip

be described with the aid of the theory of bifurcations. It should be noted, however, that only waves close to a planar wave can be studied with the aid of this theory. A study of well-developed modes at a distance from a planar wave already requires computer calculations. It is, nevertheless, a remarkable fact that both calculations and physical experiment show that developed modes have the very same character as nascent modes, i.e., during the birth of modes their fundamental characteristic features are already manifest. These modes persist up to secondary bifurcations. Computer calculations of developed modes for similar problems were carried out in [Bay 5, Iv1 1, 2, Sch 1, 2, Vol 46]. One of the results is the following: a spinning mode appearing during the first bifurcation ($R = R_1$) is maintained up to the second bifurcation ($R = R_2$), and then two stable modes are present, a one-spot spinning and a two-spot spinning mode.

Strip. In two-dimensional space, the cylinder Ω converts to a strip: $-\infty < x_1 < \infty$, $0 \leq x_2 \leq R$, and problem (5.3) has the form

$$(5.21) \quad \frac{d^2 g}{dx_2^2} + sg = 0, \quad \frac{dg}{dx_2} \Big|_{x_2=0, x_2=R} = 0.$$

The eigenvalues s are simple, and the first term of expansion (5.6), in accordance with equation (5.7), has the form

$$y_1 = \operatorname{Re}[\theta(x_1) \exp(i\tau)] \cos(k\pi x_2/R),$$

where, assuming that $s > 0$, k takes on the values $1, 2, \dots$. Upon studying, as we did above, the maxima of components of this vector-valued function, we obtain wave propagation modes which, by analogy with combustion, can be called one-spot modes, two-spot modes, etc. The character of the motion of the spots (of the maxima) is shown in Figures 5.3 and 1.9. Figure 5.3 shows a one-spot mode in the form in which it is obtained using the first term y_1 of expansion (5.6); Figure 1.9 shows a two-spot mode with the contribution of succeeding terms of the expansion taken into account.

Cylindrical domain with square cross-section ($-\infty < x_1 < \infty$, $0 \leq x_2, x_3 \leq R$). Eigenvalues s of problem (5.3) can have different multiplicity. The first term y_1 of expansion (5.6) has, in accordance with equation (5.7), the form

$$y_1 = \operatorname{Re}[\theta(x_1) \exp(i\tau) \cos(k\pi x_2/R) \cos(l\pi x_3/R)],$$

where k and l are nonnegative integers. Without stopping to give a full description of the possible modes, we cite some examples. When $k = l = 1$, the mode that appears represents (Figure 1.16) the simultaneous motion of two hot spots along opposite edges of the cylinder, with their subsequent transition to two other edges

of the cylinder, etc. For $k = l = 2$ the mode obtained is shown in Figure 1.17 and is a mode observed in combustion. A study has shown, in the case of eigenvalues s of problem (5.3) of multiplicity two, that a simultaneous bifurcation of modes of two types is possible (analogous to the appearance of spinning and symmetric modes in a circular cylinder), and, under certain conditions, modes of three types. In the case of multiple eigenvalues (as is well known, problem (5.3) in a square has eigenvalues of arbitrary large multiplicity) the problem of explaining the number of modes emerging and their form reduces to the solution of some algebraic equations.

Nonlinear stability analysis of specific combustion models is discussed in the supplement to Part III. We note finally that some problems of bifurcations of waves are studied in [Bar 1, 2, Gils 1, Kop 4, Nis 2].

§6. Traveling waves in physics, chemistry, and biology

Studies of wave solutions of parabolic equations evolved, to a significant degree, under the influence of problems of physics, chemistry, and biology. A major role here was played by Kolmogorov, Petrovskiĭ, and Piskunov [Kolm 1] and by Fisher [Fis 1] on the propagation of dominant genes; by Zel'dovich and Frank-Kamenetskiĭ [Zel 2, 5, Fran 1] on combustion theory; and by Semenov on cold flames [Vor 1, Sem 1].

Many physical, chemical, and biological phenomena which were observed experimentally and can be modeled by traveling wave solutions of parabolic systems are discussed in [Vas 2]. There are also many other works devoted to a description and investigation of this kind of models (see [Aut 1, Baren 1, Buc 7, Dik 1, Dyn 1, Fife 1, 2, Gray 2, Grin 3, Gus 1, Had 1, Iva 1, Korob 1, Kuz 1, Lan 1, Luk 1, 2, Mas 1, Mur 1, Non 1, 2, Nov 2, Pro 1, Rab 1, Rom 1, 2, Sco 1, 2, Sem 2–5, Svi 1, 2, Vol 47, Zel 5–11, Zha 1, Zve 1]).

Most of the mathematical works are devoted to traveling waves described by the equations of chemical kinetics (some biological models lead to the same mathematical models), combustion, and propagation of nerve impulse.

It was mentioned above that propagation of nerve impulse can be described by the Hodgkin-Huxley equations or by simpler Fitz-Hugh-Nagumo equations. The latter have form

$$\begin{aligned}\frac{\partial u_1}{\partial t} &= \frac{\partial^2 u_1}{\partial x^2} + F(u_1) - u_2, \\ \frac{\partial u_2}{\partial t} &= bu_1,\end{aligned}$$

where b is a constant, F is a given function.

There are many works devoted to the problem of existence of impulses, systems of impulses, periodic waves, and to the problem of their stability and to other problems (see [Bel 2, Car 1–3, Cas 1, Eva 1–6, Fer 1, 2, Has 1–3, Kla 3, Liu 1, 2, McK 2, Rau 1, Rin 1–3, Schon, Tal 1, Troy 1, Yan 1, 2] and the references presented in §3 and in §5 of Chapter 3).

We discuss now in more detail the models of chemical kinetics and combustion. Part III of the book is devoted to the investigation of these models.

We consider a chemical reaction in which substances taking part (and being generated) are denoted by $\tilde{A}_1, \dots, \tilde{A}_m$ and which is described by n elementary

reactions (stages)

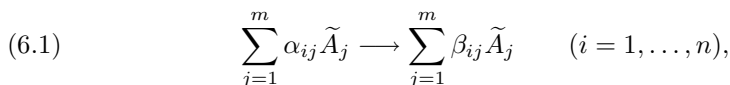

the nonnegative integers α_{ij} (or β_{ij}), which indicate how many molecules of reagent \tilde{A}_j take part (or are formed) in the reaction, are called stoichiometric coefficients.

The rate of the i th reaction, i.e., the rate of transformation of the initial substances into the reaction products, can be written in the form

$$(6.2) \quad \Phi_i = A_1^{\alpha_{i1}} \times \dots \times A_m^{\alpha_{im}} k_i(T),$$

where T is the temperature, $k_i(T)$ are the thermal coefficients of the reaction rate, and the A_i are the concentrations of substances \tilde{A}_i . Expression (6.2) is written under the assumption that the law of mass action is satisfied (see, e.g., [Den 1]).

If we assume that the concentrations of all the substances are distributed in space uniformly, then their change with time may be described by the kinetic (nondistributed) system of equations

$$(6.3) \quad \frac{dA}{dt} = \Gamma \Phi,$$

where $A = (A_1, \dots, A_m)$, $\Phi = (\Phi_1, \dots, \Phi_n)$, $\gamma_{ij} = \beta_{ij} - \alpha_{ij}$, and

$$\Gamma = \begin{bmatrix} \gamma_{11} & \cdots & \gamma_{n1} \\ \cdots & \cdots & \cdots \\ \gamma_{1m} & \cdots & \gamma_{nm} \end{bmatrix}.$$

But if the concentrations are distributed nonuniformly in space, and the chemical reaction is accompanied by diffusion of components, then the distribution of concentrations in time and space is described by the parabolic system of equations

$$(6.4) \quad \frac{\partial A}{\partial t} = d\Delta A + \Gamma \Phi,$$

where d is the coefficient of diffusion, which here, for simplicity, we assume to be the same for all substances and constant; Δ is the Laplace operator.

A chemical reaction may be accompanied by liberation or absorption of heat. In this case system (6.4) must be supplemented by the heat conduction equation

$$(6.5) \quad \frac{\partial T}{\partial t} = \varkappa \Delta T + \sum_{i=1}^n q_i \Phi_i,$$

where q_i is the adiabatic heating due to the i th reaction, and \varkappa is the thermal diffusivity coefficient. These quantities are assumed to be constants.

We have presented here a thermal diffusion model of combustion in which no account is taken of the influence of hydrodynamic factors on the propagation of a wave of combustion. Without going into detail on the question of its applicability, we point out that in a number of cases the influence of hydrodynamics can be neglected [Zel 5].

We now present some of the simplest and most frequently encountered special cases of system (6.4), (6.5), limiting ourselves here to the case of one spatial variable (for bibliographical commentaries see the supplement to Part III).

A single-stage reaction of the n th order

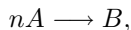

accompanied by heat liberation, may be described by the system of equations

$$(6.6) \quad \begin{aligned} \frac{\partial T}{\partial t} &= \varkappa \frac{\partial^2 T}{\partial x^2} + qk(T)A^n, \\ \frac{\partial A}{\partial t} &= d \frac{\partial^2 A}{\partial x^2} - k(T)A^n. \end{aligned}$$

In moving coordinates connected with a wave the stationary system has the form

$$(6.7) \quad \begin{aligned} dA'' - cA' - k(T)A^n &= 0, \\ \varkappa T'' - cT' + qk(T)A^n &= 0, \end{aligned}$$

where c is the wave speed. Conditions at infinity are given by

$$\begin{aligned} T(-\infty) &= T_0, & A(-\infty) &= 1, \\ T(+\infty) &= T_b, & A(+\infty) &= 0. \end{aligned}$$

Here T_0 is the initial temperature of the mixture and T_b is the burning temperature, which is obtained from a first integral of the problem; $T_b = T_0 + q$.

This model is, apparently, the most widely used in the theory of waves of combustion and is a model on which studies of many features of combustion processes have been made. Above all, we note that the function $k(T)$ is strongly nonlinear and increases rapidly with an increase in temperature. As a rule the Arrhenius temperature dependence of the reaction rate,

$$k(T) = k_0 \exp(-E/RT),$$

is considered. Here E is the activation energy of the chemical reaction, R is the universal gas constant, and k_0 is a pre-exponential factor. For large values of activation energy, which are characteristic of combustion processes, the chemical reaction rate for low temperatures close to T_0 is many orders less than the reaction rate for high temperatures close to T_b . We can therefore set $k(T) \equiv 0$ for $T \leq T_*$, where $T_*: T_0 < T_* < T_b$, the so-called cutting-off temperature of the source. This guarantees equality to zero of the reaction rate for $x = -\infty$, and, consequently, fulfillment of the necessary condition for existence of a wave solution. The approach indicated expresses the fact that a stationary combustion wave is an intermediate asymptotic behavior [**Baren 4, 5**] of a nonstationary wave, i.e., it exists up to those times of a process when the initial conditions are already forgotten and the reaction in the cold mixture is still negligibly small. The approach associated with cutting-off the source requires some justification showing that all the characteristics of a combustion wave depend weakly on a cutting-off temperature selected over a wide range. These questions are discussed in Chapter 10 on the basis of the minimax representation of the speed described above.

A strong dependence of the reaction rate on the temperature means that the chemical reaction occurs mainly in a narrow temperature interval for temperatures close to the combustion temperature, since for lower temperatures the combustion rate is relatively small. This makes it possible to apply an approximate approach, in which it is assumed that the reaction occurs only at a certain point, at which solutions of linear equations (6.7) (without a source) obtained to the left and

to the right of the reaction zone must be matched, according to specific rules. This approach allows approximate determination of the speed of a combustion wave [Zel 1, 2] and of the stability boundary of a stationary wave with respect to small perturbations [Baren 3]. Results obtained by the method described above have been compared many times with the results of numerical calculations and asymptotic approaches and, as a rule, they turn out to be fairly precise (see the supplement to Part III).

The nature of the loss of stability of a combustion wave depends on the Lewis number $Le = \varkappa/d$. If $Le > 1$, then the loss of stability with a change in the parameters of a system occurs in an oscillatory manner: for an operator linearized on a wave a pair of complex conjugate eigenvalues passes from the left half-plane of the complex plane into the right half-plane across the imaginary axis. In this case a Hopf bifurcation occurs (see §5) and, instead of the propagation of a planar combustion wave with constant speed, there may be established either an auto-oscillation (in the one-dimensional case) or spinning modes or other spatial modes (in the multi-dimensional case) described in §1.

If $Le < 1$, an eigenvalue of the linearized operator passes into the right half-plane through zero, and, in the multi-dimensional case, a stationary mode is established with a curved reaction front. When we further move into the domain of instability, the indicated modes can, in turn, lose their stability, new modes then appear, and so forth, up to the appearance of chaotic regimes.

For a fixed value of the Lewis number the stability of a wave is determined by the value of the dimensionless parameter $Z = qE/(2RT_b^2)$: for $Z < Z_{cr}(Le)$ the stationary wave is stable; for $Z > Z_{cr}(Le)$ it is unstable. The closer the Lewis number approaches 1, the wider becomes the domain of stability: $Z_{cr}(Le) \rightarrow \infty$ as $Le \rightarrow 1$.

When $Le = 1$, values of the temperature and concentration in a stationary combustion wave are related linearly; this allows us to reduce problem (6.6) to a scalar equation. Stability of a wave in this case was first proved in [Baren 2], and the approach to a wave in this case was discussed in [Kan 3] and [Kolm 1]. In the sequel these questions are discussed in a whole series of papers (see Part I).

Existence of waves for system (6.6) was established in [Kan 4]. It was shown there that for $d < \varkappa$ the wave is unique. In [Bac 1] for $d > \varkappa$ it was shown, for a specially selected model (somewhat different from (6.6)), that the wave can be nonunique.

The next step, using a more complicated model of combustion, is the consideration, after (6.6), of the simplest problems of stage combustion. The problems most investigated are waves of combustion in which we have:

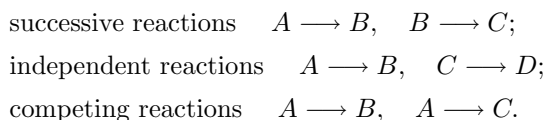

Other model schemes have also been considered. Various combustion modes have been studied, including their stability; it was shown, in particular, that in the case of competing reactions the combustion wave can be nonunique (see the supplement to Part III).

In Chapter 9 combustion waves are studied for a sufficiently general kinetics of a chemical reaction. The existence of waves is proved under specific assumptions on

the reaction scheme (6.1). In a number of cases the system of equations (6.4), (6.5) is reduced to a monotone system, making it possible to prove stability of waves and to obtain a minimax representation of the speed.

In the study of combustion waves it may be assumed, as has already been stated, that the reaction rate at low temperatures is very small, lacking which a combustion wave cannot exist. A somewhat different situation occurs for chain flames, a study of which was initiated by Semenov [**Vor 1, Sem 1**]. The simplest model in which a cold (chain) flame can be realized has the form

$$(6.8) \quad \begin{aligned} d_1 A'' - cA' - kAB^n &= 0, \\ d_2 B'' - cB' + kAB^n &= 0, \\ x \rightarrow -\infty: \quad A &= 1, \quad B = 0, \\ x \rightarrow +\infty: \quad A &= 0, \quad B = 1. \end{aligned}$$

This system of equations describes the propagation of a wave of a chemical transformation for an auto-catalytic reaction

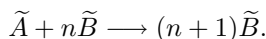

If $d_1 = d_2$, then the concentrations are connected by means of the relation $A + B = 1$ and the system of equations (6.8) may be reduced to a single equation for which questions of existence, stability, and the determination of wave speed have been well studied (see Chapter 1). We note that for $n = 1$ this equation becomes the KPP equation. This abbreviation is often used to denote the work [**Kolm 1**] and the type of nonlinearity considered there. The case $d_1 \neq d_2$ was considered in [**Bil 1–3**].

There are papers in which other models of chain flames are discussed. A series of models of such processes is examined in Chapter 8. This also discusses one of the models of the Belousov-Zhabotinsky reaction, which has been the subject of many papers.

Mathematical models close to those considered, to which methods developed in this book can be applied, also arise in heterogeneous catalysis (see Chapter 8) in the study of combustion processes in a stream [**Kha 9, Mer 9, Vol 17, Zai 1**] and also in several other areas of chemical kinetics and combustion [**Ald 15, 17, Bow 1, Ter 6**]. We remark also that a number of models in biology and ecology may be described by systems of equations of chemical kinetics type.

Part I

Stationary Waves

CHAPTER 1

Scalar Equation

§1. Introduction

In this chapter we consider waves described by the scalar parabolic equation

$$(1.1) \quad \frac{\partial u}{\partial t} = \frac{\partial^2 u}{\partial x^2} + F(u).$$

Function $u(x, t)$ is defined for $-\infty < x < +\infty$, $t \geq 0$; the initial condition

$$(1.2) \quad u(x, 0) = f(x)$$

is assumed to be bounded and piecewise-continuous with a finite number of points of discontinuity; $F(u)$ is a continuously differentiable function.

As already indicated, by a solution of traveling wave type (or, for simplicity, a wave) we mean a solution of equation (1.1) of the form

$$u(x, t) = w(x - ct),$$

where c is a constant called the speed of the wave. We assume that $w(x)$ is bounded on the whole axis and twice continuously differentiable. Obviously, function $w(x)$ satisfies the equation

$$(1.3) \quad w'' + cw' + F(w) = 0,$$

or the system of two first order equations

$$(1.4) \quad w' = p, \quad p' = -cp - F(w).$$

Along with the function $w(x)$, the function $w(x + h)$ is also a solution of equation (1.3) for arbitrary h , $-\infty < h < +\infty$. Therefore, each wave generates a one-parameter family of solutions of equation (1.3), which are obtained from one another by a translation in x . Later on, whenever necessary, we impose an additional condition, allowing us to single-out one of the solutions of this family.

Waves described by a scalar equation can be monotone in x , periodic in x , and nonmonotone, but having the limits

$$(1.5) \quad \lim_{x \rightarrow \pm\infty} w(x) = w_{\pm}.$$

In those cases where we need to indicate values of limits of function $w(x)$ as $x \rightarrow \pm\infty$, we call such waves $[w_+, w_-]$ -waves ($w_+ < w_-$). In the main, here, we consider

monotone waves, since they, in contrast to nonmonotone waves, are stable (see §5). In §3 we shall show that if the limits (1.5) exist and the inequality

$$w_+ \leq w(x) \leq w_-, \quad -\infty < x < +\infty,$$

holds, the wave is then monotone, the derivatives $w'(x)$ and $w''(x)$ tend to zero as $x \rightarrow \pm\infty$, and the values $w = w_{\pm}$ are zeros of function $F(w)$,

$$(1.6) \quad F(w_+) = F(w_-) = 0$$

(equation (1.6) follows from (1.5) even for nonmonotone waves). Therefore, for the existence of monotone waves it is obviously necessary that there exist at least two zeros of function $F(w)$. (Formally, the function $w(x) \equiv w_{\pm}$ is also a wave; however, such degenerate waves are not considered here.)

The properties of function $F(w)$ determine the existence of waves, their number, and their stability. Therefore, in what follows, our study of waves is made taking into account the type of the nonlinear source. We recall here the classification of sources given in the Introduction. A function $F(w)$, given on the interval $[a, b]$ ($a < b$) and vanishing at its endpoints ($F(a) = F(b) = 0$), is a source of Type A on this interval if points a and b are stable stationary points of the equation

$$(1.7) \quad \frac{du}{dt} = F(u),$$

with respect to this interval; it is a source of Type B if one of the stationary points is stable (see Figure 1.1a) and the other unstable; finally, it is a Type C source if both points are unstable.

Other names appearing in the literature will be also used for these types of sources. A source of Type A corresponds to the bistable case, Type B to the monostable case, and Type C to the unstable case.

It is obvious that point a is stable (with respect to interval $[a, b]$) if function $F(w)$ is negative in some right half-neighborhood of this point or vanishes on some sequence $\{w_n\}$, $w_n > a$, converging to a as $n \rightarrow \infty$. In the first instance we use the notation $F(w) \in r^-(a)$; in the second instance we use the notation $F(w) \in r^0(a)$. If function $F(w)$ is positive in some right half-neighborhood of point a , then this stationary point is unstable and, in this case, we use the notation $F(w) \in r^+(a)$. We shall use the notation $l^-(b)$, $l^0(b)$, and $l^+(b)$ to indicate the behavior of function $F(w)$ in a left-neighborhood of point b .

To the solution $w(x)$ of equation (1.3), having the limits (1.5) at infinity, there corresponds a trajectory $(w(x), p(x))$ of the system of equations (1.4), joining the singular points $(w_-, 0)$ and $(w_+, 0)$ of this system. It is clear that existence and properties of such trajectories can depend on the type of singular points. It is readily seen that the eigenvalues of the system, linearized in a neighborhood of a singular point, are calculated as the roots of a quadratic equation,

$$\lambda_{1,2} = -c/2 \pm (c^2/4 - \alpha)^{1/2},$$

where α is the value of the derivative of function $F(w)$ at the corresponding point; for example, $\alpha = F'(w_+)$ for the singular point $(w_+, 0)$. Therefore, for $\alpha < 0$ the singular point is a saddle point; for $\alpha > 0$ and $c^2/4 \geq \alpha$ it is a node. Moreover, in case $c > 0$, the node is stable; for $c < 0$, it is unstable. We note, in the case $c^2/4 = \alpha$, that the eigenvalues take on identical values and that, in some cases, this proves to be important. In case $c^2/4 < \alpha$, the eigenvalues are complex, and the

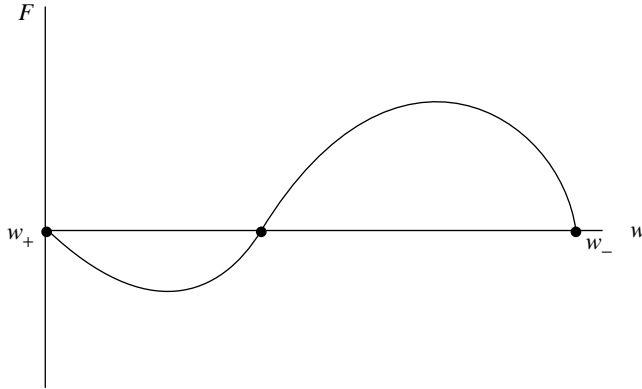

FIGURE 1.1a. A Type A source (bistable)

singular point is a focus ($c \neq 0$); there can therefore be no monotone waves tending towards this singular point.

In the case $\alpha = 0$, the type of singular point, as is well known, is not completely determined by the eigenvalues. If $F \in r^-(w_+) \cap l^+(w_+)$, then we have a saddle point; if $F \in r^+(w_+) \cap l^-(w_+)$ and $c \neq 0$, we have a node. In other cases, we can have complex singular points of saddle-node type, etc.

Analysis of the behavior of trajectories in a two-dimensional phase space is sufficiently simple (at least in comparison with multi-dimensional space) and this makes it possible to prove the existence of waves described by a scalar equation in precisely this way. We emphasize that in equation (1.3), as well as in the system of equations (1.4), the quantity c is not given. Thus when the question concerns existence of a wave, our concern is to determine a value of c for which a solution exists with the specified properties. The simplest forms of sources of various types are shown in Figures 1.2–1.6 of the Introduction. We show, in the figures cited below, the behavior of trajectories in the phase plane for various values of the speed c .

We turn our attention to a simple property of the trajectories of the system of equations (1.4) which become obvious upon reducing this system to the equation

$$\frac{dp}{dw} = -c - \left(\frac{F(w)}{p} \right).$$

If we consider an arbitrary trajectory of this system for some $c = c_0$ in the half-plane $p < 0$, for definiteness, then, for $c > c_0$ the trajectories intersect it “from below upwards”, and for $c < c_0$ “from above downwards” (see Figures 1.1b–d). Therefore, as c increases, the trajectory which leaves the stable singular point $(w_-, 0)$ and moves into the half-plane $p < 0$ “rises”, while the trajectory which comes into the singular point $(w_+, 0)$ “drops”. This makes it possible to prove easily the existence of a wave and its uniqueness (i.e., uniqueness of the value of the speed for which the wave exists, and uniqueness of a wave for a given c) for sufficiently simple Type A sources. For more complex sources proof of the existence of waves is correspondingly more involved. Moreover, a wave, taking given values at infinity, may, generally speaking, even not exist. For example, for Type A sources with one intermediate stable (relative to equation (1.7)) point, a (w_+, w_-) -wave exists if $c_2 > c_1$, and does not exist if $c_2 \leq c_1$ (Figure 1.2).

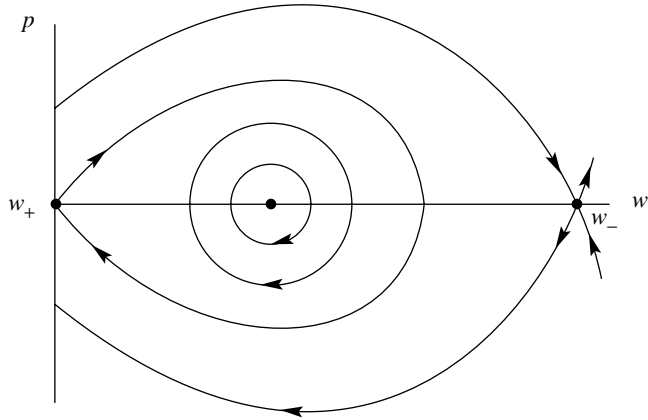
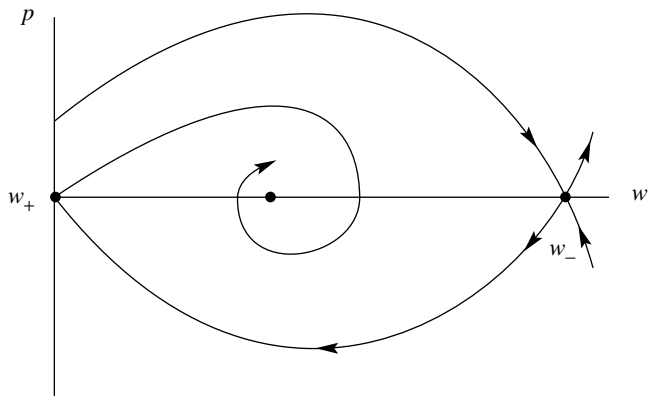
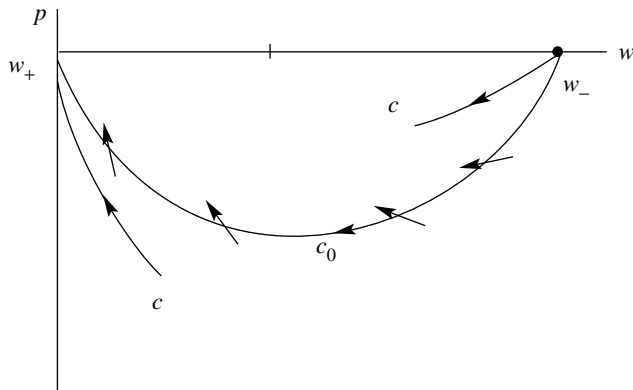
FIGURE 1.1b. Trajectories of sytem (1.4): $c = 0$ FIGURE 1.1c. Trajectories of sytem (1.4): $c = c_0$, c_0 is the wave speedFIGURE 1.1d. Trajectories of sytem (1.4): $c > c_0$

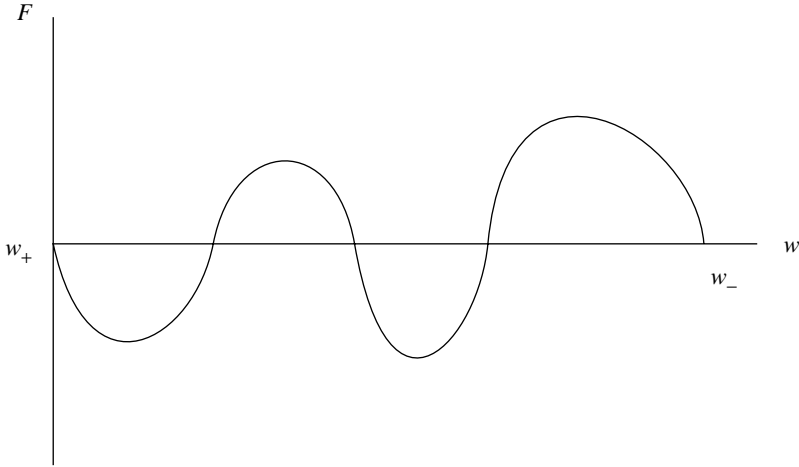

FIGURE 1.2a. A Type A source with one stable intermediate stationary point

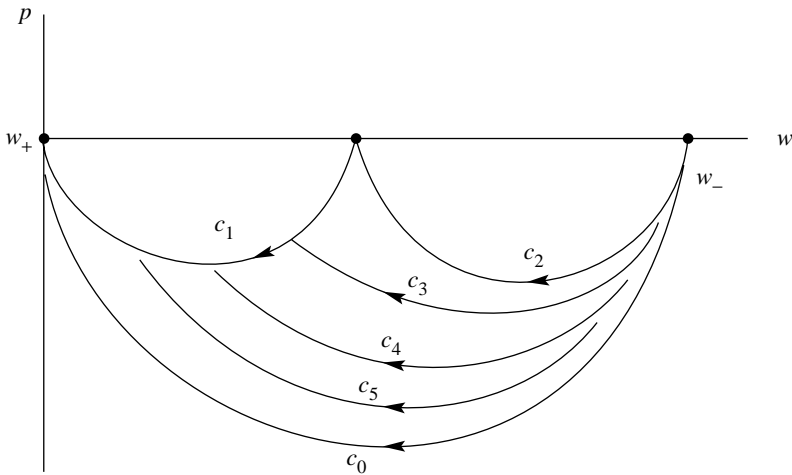

FIGURE 1.2b. Trajectories of system (1.4): $c_2 > c_1$, $c_2 > c_3 > c_4 > c_5 > c_0 > c_1$, c_0 is the wave speed

For Type B sources (monostable case) waves exist, no longer for a unique value of the speed, but for a half-interval or a half-axis of speeds. For example, for the source shown in Figure 1.3, (w_+, w_-) -waves exist for all $c \geq c_0$, where c_0 is the minimal speed ($c_0 \geq 2(F'(w_+))^{1/2}$). This is also readily established from an analysis of the disposition of trajectories in the phase plane. The material supplied here is intuitive. A precise formulation of results and their proofs is given in the following sections.

In conclusion, we turn our attention to the content of this chapter. In §2 we introduce functionals, which are used later to prove existence of waves and systems of waves (§3). In §4 we supply certain properties of solutions of parabolic

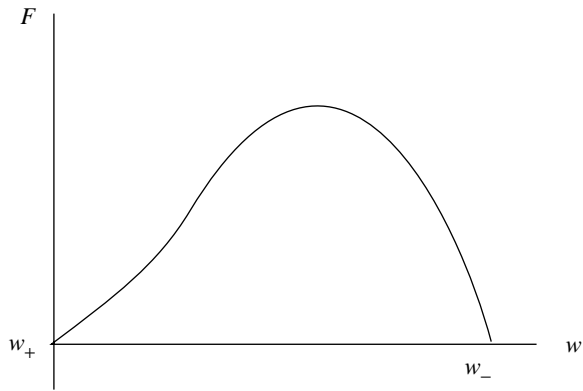
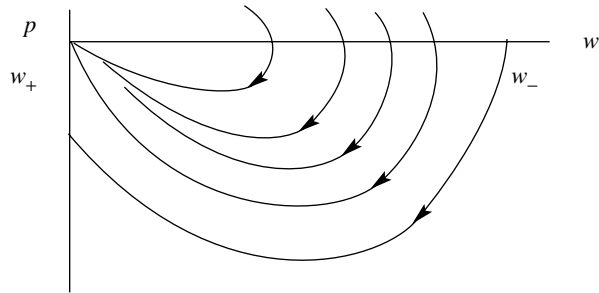
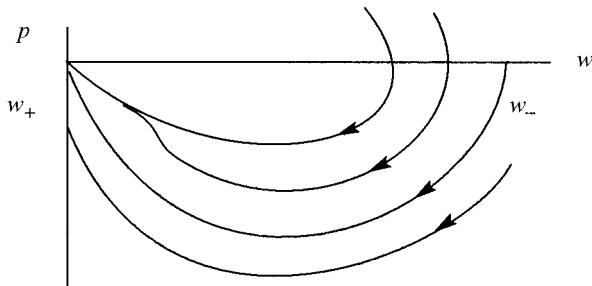

FIGURE 1.3a. A Type B source (monostable case)

FIGURE 1.3b. Trajectories of system (1.4): $c < c_0$ FIGURE 1.3c. Trajectories of system (1.4): $c = c_0$

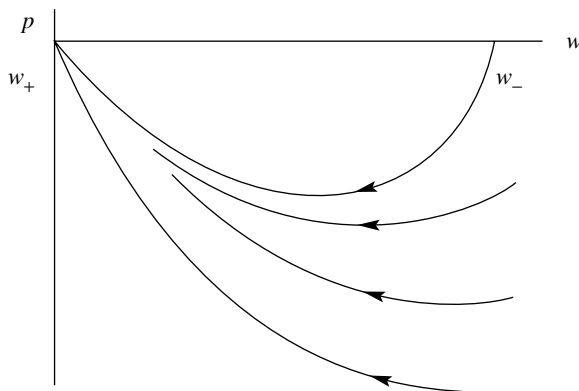

FIGURE 1.3d. Trajectories of system (1.4): $c > c_0$, c_0 is the minimal wave speed

equations; in §5 we examine conditions for the approach of solutions of Cauchy problem (1.1), (1.2) to a wave and system of waves. We remark that no study is made in this chapter of the stability of waves to small perturbations. These topics will be taken up in Chapters 4, 5 in connection with systems of equations and all the results given there will also be valid for a single equation.

§2. Functionals ω_* and ω^*

2.1. Definition of functionals. Let C_α be a set of absolutely continuous functions $\rho(u)$, given on the interval $[a, b]$ and satisfying the conditions

$$(2.1) \quad \rho(a) = 0, \quad \rho(u) > 0 \quad \text{for} \quad u \in (a, b).$$

For $\rho \in C_\alpha$ we set

$$(2.2) \quad \psi^*(\rho) = \sup \left(\rho'(u) + \frac{F(u)}{\rho(u)} \right),$$

where sup is taken over all those $u \in (a, b)$ for which derivative $\rho'(u)$ exists. We set

$$(2.3) \quad \omega^* = \inf \psi^*(\rho),$$

where inf is taken over all $\rho \in C_\alpha$. ω^* is a functional of F , which we shall denote by $\omega^*[F]$, if we need to indicate dependence on F .

In a similar way we define ω_* . Let C_b be a set of absolutely continuous functions, given on the interval $[a, b]$ and satisfying the conditions

$$(2.4) \quad \rho(b) = 0, \quad \rho(u) > 0 \quad \text{for} \quad u \in [a, b).$$

Let us set

$$(2.5) \quad \psi_*(\rho) = \inf \left(\rho'(u) + \frac{F(u)}{\rho(u)} \right),$$

where inf is taken over all those $u \in (a, b)$ for which derivative $\rho'(u)$ exists. We set

$$(2.6) \quad \omega_* = \sup \psi_*(\rho),$$

where sup is taken over all $\rho \in C_b$.

2.2. Connection with solutions of the equation $p' + F/p + c = 0$.
Consider the equation

$$(2.7) \quad p'(u) + \frac{F(u)}{p(u)} + c = 0.$$

As usual, we denote by $C[a, b]$ and $C^1(a, b)$ the sets of functions continuous on $[a, b]$ and having continuous derivatives on (a, b) , respectively.

THEOREM 2.1. *In order for there to exist a solution $p(u)$ of equation (2.7) on the interval (a, b) , satisfying the conditions*

$$(2.8) \quad \begin{aligned} p &\in C^1(a, b) \cap C[a, b], & p(a) &= 0, \\ p(u) &< 0 & \text{for } u &\in (a, b), \end{aligned}$$

it is necessary that the inequality

$$(2.9) \quad c \geq \omega^*$$

be satisfied and sufficient that the inequality

$$(2.10) \quad c > \omega^*$$

be satisfied.

PROOF. Assume that a solution p of problem (2.7), (2.8) exists. Then

$$\rho = -p \in C_\alpha.$$

From (2.7) we have $c = \psi^*(\rho)$, from whence (2.9) follows. Next, assume that inequality (2.10) is satisfied. Then there exists a function $\rho \in C_\alpha$ such that

$$\psi^*(\rho) < c.$$

Consider now a solution $p_\nu(u)$ of equation (2.7) with initial condition $p_\nu(a) = -\nu$, where ν is a sufficiently small positive number. We show that

$$(2.11) \quad p_\nu(u) < p(u) \quad \text{for } u \in [a, b],$$

where $p(u) = -\rho(u)$. Assume the contrary to be true. Then there exists a number $u_0 \in (a, b]$ such that

$$(2.12) \quad p_\nu(u_0) = p(u_0), \quad p_\nu(u) < p(u) \quad \text{for } u \in [a, u_0).$$

We now select ε satisfying the inequalities

$$(2.13) \quad 0 < \varepsilon < c - \psi^*(\rho),$$

and a number $u_1 \in (a, u_0)$, such that

$$(2.14) \quad \frac{1}{u_0 - u_1} \int_{u_1}^{u_0} \left[\frac{F(u)}{p(u)} - \frac{F(u)}{p_\nu(u)} \right] du < \varepsilon.$$

Since $p_\nu(u)$ is a solution of equation (2.7), then

$$(2.15) \quad p_\nu(u_0) - p_\nu(u_1) + \int_{u_1}^{u_0} \frac{F(u)}{p_\nu(u)} du = -c(u_0 - u_1).$$

From (2.2) we have

$$-p'(u) - (F(u)/p(u)) \leq \psi^*(\rho)$$

almost everywhere on (a, b) , from whence we have

$$p(u_0) - p(u_1) + \int_{u_1}^{u_0} (F(u)/p(u)) du \geq -\psi^*(\rho)(u_0 - u_1).$$

Subtracting (2.15) from this inequality and taking (2.13) and (2.14) into account, we obtain $p_\nu(u_1) > p(u_1)$, which contradicts (2.12). Thus we have established inequality (2.11).

We now pass to the limit as $\nu \rightarrow 0$. We obtain the solution $p_0(u)$ of equation (2.7), satisfying conditions $p_0(a) = 0$, $p_0(u) \leq p(u)$ for $u \in [a, b]$. Therefore $p_0(u)$ satisfies conditions (2.8). This completes the proof of the theorem. \square

THEOREM 2.2. *In order that there exist a solution $p(u)$ of equation (2.7) on the interval (a, b) , satisfying the conditions*

$$(2.16) \quad p \in C^1(a, b) \cap C[a, b], \quad p(b) = 0, \quad p(u) < 0 \quad \text{for} \quad u \in [a, b),$$

it is necessary that the inequality

$$(2.17) \quad c \leq \omega_*$$

be satisfied and sufficient that the inequality

$$c < \omega_*$$

be satisfied.

The proof of this theorem is similar to the proof of Theorem 2.1.

COROLLARY. *Problem (2.7), (2.8) (problem (2.7), (2.16)) is solvable for at least one c if and only if $\omega^* < \infty$ ($\omega_* > -\infty$). Upon satisfaction of this condition, $\omega^* = \inf c$ ($\omega_* = \sup c$), where \inf (\sup) is taken over the set of all c for which this problem is solvable.*

The proof is obvious.

2.3. Estimates of functionals. Here we present simplest estimates of the functionals ω_* and ω^* , which we shall need later on. We first prove the inequality

$$(2.18) \quad \omega_* \leq \omega^*.$$

Assume the contrary to be true. Then there exists a number c such that

$$\omega^* < c < \omega_*.$$

On the basis of Theorems 2.1 and 2.2 there exist solutions of problems (2.7), (2.8) and (2.7), (2.16). These solutions obviously take on equal values for some $u \in (a, b)$, which contradicts uniqueness of a solution of the Cauchy problem for equation (2.7).

We introduce the notation

$$(2.19) \quad \gamma^* = \sup_{u \in (a,b)} \frac{F(u)}{u-a}, \quad \gamma_* = \inf_{u \in (a,b)} \frac{F(u)}{b-u}.$$

THEOREM 2.3. *We have the following relations:*

$$(2.20) \quad \omega_* = \omega^* = -\infty \quad \text{if} \quad \gamma^* < 0,$$

$$(2.21) \quad \omega_* = \omega^* = \infty \quad \text{if} \quad \gamma_* > 0,$$

$$(2.22) \quad -2|\gamma_*|^{1/2} \leq \omega_* \leq \omega^* \leq 2|\gamma^*|^{1/2} \quad \text{if} \quad \gamma^* \geq 0, \quad \gamma_* \leq 0.$$

PROOF. All the inequalities may be proved in the same way, using the function $\rho = k(u-a)$ ($k > 0$) for estimates of the functional ω^* , and using the function $\rho = k(b-u)$ ($k > 0$) for estimates of the functional ω_* . We give, for example, the proof of the right-hand inequality in (2.22). For $\rho = k(u-a)$ the functional $\psi^*(\rho)$ (see (2.2)) takes the form

$$\psi^*(\rho) = k + (\gamma^*/k).$$

For $\gamma^* \geq 0$, taking inf over k , we obtain $2(\gamma^*)^{1/2}$. The last inequality in (2.22) follows from this. \square

THEOREM 2.4. *Let $F(u) \in C^1[a, b]$. Then*

$$(2.23) \quad \omega_* = \omega^* = \infty,$$

if $F(b) = 0$, $F(u) > 0$ for $u \in [a, b)$, and

$$(2.24) \quad \omega_* = \omega^* = -\infty$$

if $F(a) = 0$, $F(u) < 0$ for $u \in (a, b]$.

PROOF. We prove equality (2.23). Set $\rho(u) = kF(u)$ ($k > 0$). We have $\psi_*(\rho) = k^{-1} - \sigma k$, where $-\sigma = \inf F'(u)$ for $u \in (a, b)$. It follows from this that $\omega_* \geq k^{-1} - \sigma k \rightarrow \infty$ for $k \rightarrow 0$. It remains to make use of inequality (2.18). Equalities (2.24) are proved in the same way. \square

As mentioned above, we shall write $\omega^*[F]$ and $\omega_*[F]$ for indicating the dependence of ω^* and ω_* on F .

THEOREM 2.5. *If $F_1(u) \leq F_2(u)$, then*

$$(2.25) \quad \omega^*[F_1] \leq \omega^*[F_2], \quad \omega_*[F_1] \leq \omega_*[F_2].$$

If $F(u) \equiv 0$, then

$$(2.26) \quad \omega^*[F] = \omega_*[F] = 0.$$

PROOF. Inequality (2.25) follows directly from the definition of ω^* and ω_* ; relations (2.26) follow from (2.22). This completes the proof of the theorem. \square

From (2.25) and (2.26) we obviously have:

$$(2.27) \quad \omega^*[F] \geq 0, \quad \omega_*[F] \geq 0 \quad \text{if} \quad F(u) \geq 0;$$

$$(2.28) \quad \omega^*[F] \leq 0, \quad \omega_*[F] \leq 0 \quad \text{if} \quad F(u) \leq 0.$$

THEOREM 2.6. *We have the inequalities*

$$(2.29) \quad \omega_*[F] \geq 0 \quad \text{if} \quad \int_u^b F(s) ds \geq 0,$$

$$(2.30) \quad \omega^*[F] \leq 0 \quad \text{if} \quad \int_a^u F(s) ds \leq 0,$$

for all $u \in [a, b]$.

PROOF. To prove inequality (2.29) we set, for arbitrary $\varepsilon > 0$,

$$\rho_\varepsilon(u) = \left[2 \int_u^b F(s) ds + \varepsilon^2(b-u)^2 \right]^{1/2}.$$

Then $\psi_*(\rho_\varepsilon) \geq -\varepsilon$, and inequality (2.29) follows. Inequality (2.30) is proved in a similar way. This completes the proof of the theorem. \square

THEOREM 2.7. *If $F \in l^+(b)$ and a solution of problem (2.7), (2.16) exists, then $\omega_*[F] > c$.*

If $F \in r^-(\alpha)$ and a solution of problem (2.7), (2.8) exists, then $\omega^[F] < c$.*

PROOF. We prove the first assertion. The second is proved similarly.

On the basis of Theorem 2.2 it is sufficient to show that no solution of problem (2.7), (2.16) exists for $c = \omega_*$. Assume the contrary: there does exist a solution. Denote it by $p_*(u)$. Let $u_1 < b$ be such that $F(u) > 0$ for $u \in [u_1, b]$. By Theorem 2.4, applied to the interval $[u_1, b]$, and also Theorem 2.2, we conclude that, for arbitrary finite c , there exists a solution $p(u)$ of equation (2.7), satisfying conditions $p(b) = 0$, $p(u) < 0$ for $u \in [u_1, b]$. Let $c > \omega_*$ and sufficiently close to ω_* . Then, taking into account the behavior in a neighborhood of the singular point $u = b$, $p = 0$ (see Theorem 3.4), we readily see that $p(u)$ is sufficiently close to $p_*(u)$ on the interval $[a, b]$, and therefore satisfies conditions (2.16). But this contradicts Theorem 2.2. This completes the proof of the theorem. \square

COROLLARY. *If $F \in l^+(b)$ and*

$$\int_u^b F(s) ds > 0 \quad \text{for all} \quad u \in [a, b],$$

then $\omega_[F] > 0$.*

If $F \in r^-(a)$ and

$$\int_a^u F(s) ds < 0 \quad \text{for all} \quad u \in (a, b],$$

then $\omega^[F] < 0$.*

PROOF. The function

$$p(u) = - \left[2 \int_u^b F(s) ds \right]^{1/2}$$

is a solution of problem (2.7), (2.16) with $c = 0$. The first of the assertions

follows from this. The second is proved similarly. This completes the proof of the corollary. \square

2.4. Dependence on endpoints of the interval. We have defined functionals ω^* and ω_* on the interval $[a, b]$. Let us consider these functionals as functions of a and b , denoting them by $\omega_*(a, b)$ and $\omega^*(a, b)$ to indicate dependence on the ends of the interval.

THEOREM 2.8. *Functionals $\omega^*(a, u)$ and $\omega_*(u, b)$ are nondecreasing functions of u for $u \in (a, b]$ and $u \in [a, b)$, respectively.*

PROOF. Consider the functional $\omega_*(u, b)$. The proof proceeds accordingly for $\omega^*(a, u)$. Let $u_1 < u_2$, $u_1, u_2 \in [a, b)$. We need to show that

$$(2.31) \quad \omega_*(u_1, b) \leq \omega_*(u_2, b).$$

We denote by $\psi_*^1(\rho)$ and $\psi_*^2(\rho)$ functionals, defined on intervals $[u_1, b]$ and $[u_2, b]$, just as was done in §2.1 (see (2.5)) for the interval $[a, b]$. By definition, for arbitrary $\varepsilon > 0$ there exists a function $\rho \in C_b$, given on the interval $[u_1, b]$, such that

$$(2.32) \quad \psi_*^1(\rho) > \omega_*(u_1, b) - \varepsilon.$$

Taking the restriction of ρ on the interval $[u_2, b]$, we obtain

$$(2.33) \quad \psi_*^2(\rho) \geq \psi_*^1(\rho).$$

From this and from (2.31) and (2.32) we have

$$\omega_*(u_2, b) \geq \psi_*^2(\rho) \geq \omega_*(u_1, b) - \varepsilon,$$

from whence, in view of the arbitrariness of ε , (2.31) follows. This completes the proof of the theorem. \square

COROLLARY. *If $F(u) > 0$ for $a \leq u_1 < u < u_2 < b$, then*

$$(2.34) \quad \omega_*(u, b) = \omega_*(u_2, b) \quad \text{for} \quad u_1 < u \leq u_2.$$

PROOF. Assume that $\omega_*(u_2, b)$ is finite. By virtue of monotonicity, we have

$$(2.35) \quad \omega_*(u, b) \leq \omega_*(u_2, b)$$

for $u \leq u_2$. Let c be an arbitrary number:

$$(2.36) \quad c < \omega_*(u_2, b).$$

Then, based on Theorem 2.2, there exists a solution $p(u)$ of equation (2.7) satisfying the conditions

$$p(b) = 0, \quad p(u) < 0 \quad \text{for} \quad u_2 \leq u < b.$$

We extend this solution for $u < u_2$. Then $p(\bar{u}) < 0$ for $u_1 < \bar{u} < u_2$, by virtue of equation (2.7), in view of the positivity of $F(u)$. Applying Theorem 2.2 to the interval $[\bar{u}, b]$, we obtain $c \leq \omega_*(\bar{u}, b)$. Since c is an arbitrary number satisfying inequality (2.36), it follows that $\omega_*(u_2, b) \leq \omega_*(\bar{u}, b)$. Relation (2.34) then follows from this and from (2.35). For infinite values of $\omega_*(u_2, b)$ the proof is equally simple. This completes the proof of the theorem. \square

There is an analogous corollary for ω^* .

As a result of monotonicity we have the limits

$$\omega^*(a) = \lim_{u \rightarrow a} \omega^*(a, u), \quad \omega_*(b) = \lim_{u \rightarrow b} \omega_*(u, b).$$

We now find their values.

THEOREM 2.9. *We have the equalities*

$$(2.37) \quad \omega^*(a) = -\infty \quad \text{if } F(u) \in r^-(a),$$

$$(2.38) \quad \omega^*(a) = 2(F'(a))^{1/2} \quad \text{if } F(u) \notin r^-(a),$$

$$(2.39) \quad \omega_*(b) = \infty \quad \text{if } F(u) \in l^+(b),$$

$$(2.40) \quad \omega_*(b) = -2(F'(b))^{1/2} \quad \text{if } F(u) \notin l^+(b).$$

PROOF. Equality (2.37) follows from Theorem 2.4.

Let $F(u) \notin r^-(a)$. Then we have $\gamma^* \geq 0$ on the interval $[a, b]$. Therefore, by the basis of Theorem 2.3,

$$\omega^*(a, b) \leq 2(\gamma^*)^{1/2} \leq 2(\sup F'(u))^{1/2} \quad (u \in (a, b)).$$

Passing to the limit as $b \rightarrow a$, we obtain

$$\omega^*(a) \leq 2(F'(a))^{1/2}.$$

To prove equality (2.38) we obtain the opposite inequality

$$(2.41) \quad \omega^*(a) \geq 2(F'(a))^{1/2}.$$

If $F'(a) > 0$ and (2.41) is not satisfied, then taking c satisfying

$$\omega^*(a) < c < 2(F'(a))^{1/2},$$

and b sufficiently close to a , we obtain a contradiction with Theorem 2.1, since in this case a solution of equation (2.7) cannot be of constant sign, which follows from known results concerning the behavior of a solution in a neighborhood of a singular point.

If $F'(a) = 0$, then for $F(u) \in r^+(a)$ we obtain (2.41) from (2.27). Let $F(u) \in r^0(a)$ and $F(b_k) = 0$, $b_k \searrow a$. On the interval $[a, b_k]$ we have $|\gamma^*| \leq \sup |F'(u)| \rightarrow 0$ as $b_k \searrow a$. Inequality (2.41) follows from (2.22).

Equalities (2.39) and (2.40) are proved similarly. This completes the proof of the theorem. \square

§3. Waves and systems of waves

3.1. Properties of waves. In this section we consider waves and systems of waves. Recall that by an $[a, b]$ -wave we mean a function $w(x)$, bounded on the

whole axis and twice continuously differentiable (and a constant c), satisfying the equation

$$(3.1) \quad w'' + cw' + F(w) = 0,$$

and the conditions

$$(3.2) \quad \lim_{x \rightarrow \infty} w(x) = a, \quad \lim_{x \rightarrow -\infty} w(x) = b.$$

As has already been noted in the introduction to this chapter, it follows from this that

$$F(a) = F(b) = 0.$$

This assertion is readily proved and we shall not discuss it in detail. For example, it can be obtained from an analysis of the ω - and α -limiting sets of the trajectory on the phase plane using estimates of the derivatives $w'(x)$ and $w''(x)$ (see Chapter 2, §2).

Throughout the sequel we assume that the function $w(x)$ is not identically constant.

We give some simple properties of waves. It is easy to see that if function $w(x)$ satisfies the inequalities $a \leq w(x) \leq b$ ($a < b$) for all x , then these inequalities are strict. Indeed, if for some x , say, $x = x_0$, we have $w(x_0) = a$, then $w'(x_0) = 0$ and $w(x) \equiv a$.

If for some x_0 we have $w'(x_0) = 0$, then at this point $w(x)$ attains a maximum or a minimum and $F(w(x_0)) \neq 0$. Otherwise, $w''(x_0) = 0$, $F(w(x_0)) = 0$, and $w(x) \equiv w(x_0)$. It follows from this, in particular, that on each finite interval there exists not more than a finite number of extrema of function $w(x)$. It is not assumed here that $a \leq w(x) \leq b$. When these inequalities are satisfied, the function $w(x)$, as we show below, is monotone.

THEOREM 3.1. *Let a solution $w(x)$ of equation (3.1) have extrema at the points x_1 and x_2 , $x_1 < x_2$, and let $w'(x) \neq 0$ for $x_1 < x < x_2$.*

Assume, further, that $c \geq 0$ ($c \leq 0$), $x_ > x_2$ ($x_* < x_1$), and $w'(x) \neq 0$ for $x_2 < x \leq x_*$ ($x_* \leq x < x_1$). Then*

$$\min_i w(x_i) < w(x_*) < \max_i w(x_i), \quad i = 1, 2.$$

PROOF. Consider the case where x_1 is a minimum and x_2 is a maximum, i.e., $w(x_1) < w(x_2)$. Let $c \geq 0$ and $x_* \geq x_2$. Then, obviously, $w(x_*) < w(x_2)$. We show that $w(x_*) > w(x_1)$. Assume that this is not the case. We can then find an $x = \bar{x}$, $x_2 < \bar{x} \leq x_*$, such that $w(\bar{x}) = w(x_1)$. We multiply equation (3.1) by w' and integrate from x_1 to x ($x_1 < x \leq x_2$):

$$\frac{1}{2}w'^2(x) + c \int_{x_1}^x w'^2(s) ds + \int_{w(x_1)}^{w(x)} F(s) ds = 0.$$

From this, when $x = x_2$, we obtain

$$(3.3) \quad \int_{w(x_1)}^{w(x_2)} F(s) ds \leq 0.$$

We multiply equation (3.1) by w' and integrate from x_2 to \bar{x} :

$$\frac{1}{2}w'^2(\bar{x}) + c \int_{x_2}^{\bar{x}} w'^2(s) ds + \int_{w(x_2)}^{w(\bar{x})} F(s) ds = 0.$$

From this

$$\int_{w(\bar{x})}^{w(x_2)} F(s) ds > 0,$$

which contradicts (3.3). This contradiction establishes the required inequality for $c \geq 0$.

For all the remaining cases indicated in the statement of the theorem the proof is similar. This completes the proof of the theorem. \square

COROLLARY 1. *Under the assumption of the theorem, if $c \geq 0$ ($c \leq 0$), then*

$$\min_i w(x_i) < w(x) < \max_i w(x_i)$$

for $x_2 \leq x \leq \infty$ ($-\infty \leq x \leq x_1$).

COROLLARY 2. *If $w'(x_*) = 0$ for $x_* > x_2$, then*

$$w(x_*) \in (\min_i w(x_i), \max_i w(x_i))$$

for $c > 0$,

$$w(x_*) \notin (\min_i w(x_i), \max_i w(x_i))$$

for $c < 0$, and

$$w(x_*) = w(x_1) \quad \text{or} \quad w(x_*) = w(x_2)$$

for $c = 0$. In the last case $w(x)$ is a periodic function.

COROLLARY 3. *If conditions (3.2) are satisfied, where $b > a$ and*

$$a \leq w(x) \leq b, \quad -\infty < x < \infty,$$

then $w(x)$ is a monotonically decreasing function for all x .

COROLLARY 4. *If $w(x) \rightarrow a$ as $x \rightarrow \infty$ and $w(x) > a$ for $x \geq N$ for some N , then an $x_0 \geq N$ can be found such that $w(x)$ is a monotonically decreasing function for $x \geq x_0$.*

COROLLARY 5. *Under the conditions of the preceding corollary, $w'(x) \rightarrow 0$ as $x \rightarrow \infty$ and*

$$(3.4) \quad \int_{x_0}^{\infty} w'^2(s) ds < \infty.$$

PROOF. We consider the equality

$$\frac{1}{2}w'^2(x) - \frac{1}{2}w'^2(x_0) + c \int_{x_0}^x w'^2(s) ds + \int_{w(x_0)}^{w(x)} F(w) dw = 0,$$

which is obtained by integrating equation (3.1) multiplied by w' . Since function

$w(x)$ is bounded, it follows that $w'(x)$ tends towards 0 along some sequence $\{x_n\}$, $x_n \rightarrow \infty$ as $n \rightarrow \infty$. From this it follows that

$$(3.5) \quad \left| c \int_{x_0}^{\infty} w'^2(s) ds \right| < \infty,$$

from which, in turn, existence of the limit of $w'(x)$ as $x \rightarrow \infty$ follows.

Inequality (3.4) follows from the boundedness of $w'(x)$ for $x \geq x_0$ and existence of the integral $\int_{x_0}^{\infty} |w'(s)| ds$. Corollary 5 is thereby proved. \square

REMARKS. 1. The theorem remains valid for $x_1 = -\infty$ if $c \geq 0$ and for $x_2 = \infty$ if $c \leq 0$ assuming existence of the limits (3.2) at the points $x_1 = -\infty$ or $x_2 = \infty$ and the inequality $w(x) < b$ or $w(x) > a$ in a neighborhood of the points $x_1 = -\infty$ or $x_2 = \infty$, respectively. Equality to zero of the derivative $w'(x)$ and integrability of the square of the derivative which are used in the proof were shown above.

If $c = 0$ and $x_1 = -\infty$ ($x_2 = \infty$), then only one extremum is attained for finite values of x .

2. From Corollaries 4 and 5 it obviously follows, when the conditions of Corollary 4 are satisfied, that $w''(x) \rightarrow 0$ as $x \rightarrow \infty$ and $F(a) = 0$.

THEOREM 3.2. *If $c \neq 0$ and solution $w(x)$ of equation (3.1) is bounded for $x \geq 0$ ($x \leq 0$), then the limit $\lim_{x \rightarrow \infty} w(x)$ ($\lim_{x \rightarrow -\infty} w(x)$) exists.*

PROOF. Consider the case $c > 0$. Let $w(x)$ be bounded for $x \leq 0$ and assume that the limit $\lim_{x \rightarrow -\infty} w(x)$ does not exist. Then there exist sequences $\{x_n\}$, $\{y_n\}$, $x_n \rightarrow -\infty$, $y_n \rightarrow -\infty$ as $n \rightarrow \infty$, $w'(x_n) = 0$, $w'(y_n) = 0$, where a minimum of function $w(x)$ is attained at points x_n , and a maximum at points $x = y_n$,

$$y_{n+1} < x_n < y_n < \cdots < x_1 < y_1.$$

By virtue of Corollary 2 to Theorem 3.1,

$$w(y_{n+1}) > w(y_n), \quad w(x_{n+1}) < w(x_n)$$

(Figure 3.1). Let $\overline{\overline{w}} = \lim w(y_n)$, $\overline{w} = \lim w(x_n)$. We have

$$(3.6) \quad \begin{aligned} c \int_{x_n}^{y_n} w'^2(s) ds + \int_{w(x_n)}^{w(y_n)} F(w) dw &= 0, \\ c \int_{y_{n+1}}^{x_n} w'^2(s) ds + \int_{w(y_{n+1})}^{w(x_n)} F(w) dw &= 0. \end{aligned}$$

From this it follows that

$$\int_{\overline{w}}^{\overline{\overline{w}}} F(w) dw = 0.$$

We show now that

$$\int_{x_{n+1}}^{y_{n+1}} w'^2(s) ds > \int_{x_n}^{y_n} w'^2(s) ds.$$

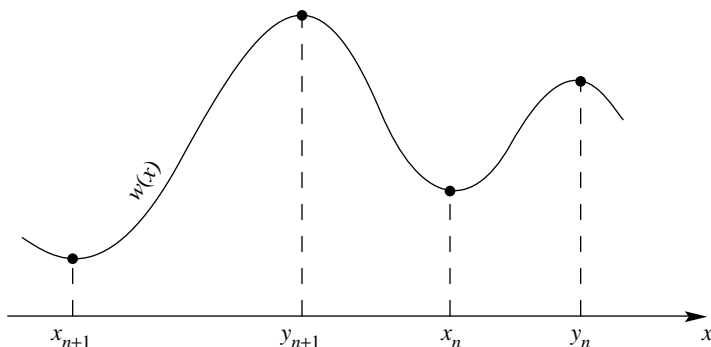

FIGURE 3.1

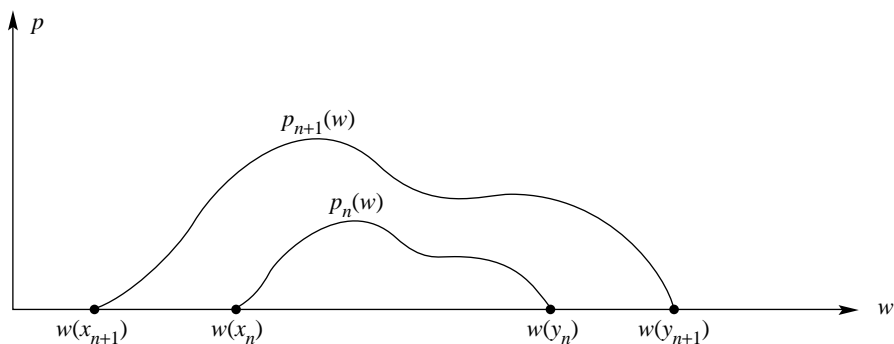

FIGURE 3.2

To this end we introduce the functions

$$\begin{aligned}
 p_{n+1}(w) &= w'(s), & \text{where } w &= w(s), & x_{n+1} &\leq s \leq y_{n+1}, \\
 p_n(w) &= w'(s), & \text{where } w &= w(s), & x_n &\leq s \leq y_n.
 \end{aligned}$$

Then

$$\begin{aligned}
 p_{n+1}(w(x_{n+1})) &= p_{n+1}(w(y_{n+1})) = 0, \\
 p_n(w(x_n)) &= p_n(w(y_n)) = 0;
 \end{aligned}$$

therefore,

$$p_{n+1}(w) > p_n(w) \quad \text{for } w(x_n) \leq w \leq w(y_n)$$

(Figure 3.2) and

$$\int_{x_{n+1}}^{y_{n+1}} w'^2(s) ds = \int_{w(x_{n+1})}^{w(y_{n+1})} p_{n+1}(w) dw > \int_{w(x_n)}^{w(y_n)} p_n(w) dw = \int_{x_n}^{y_n} w'^2(s) ds.$$

Expressing c from equation (3.6) and passing to the limit as $n \rightarrow \infty$, we obtain $c = 0$, which contradicts our assumption.

Assume now that $w(x)$ is bounded for $x \geq 0$ and that the limit $\lim_{x \rightarrow \infty} w(x)$ does not exist. Then there exist sequences $\{x_n\}$, $\{y_n\}$, tending towards ∞ , for which

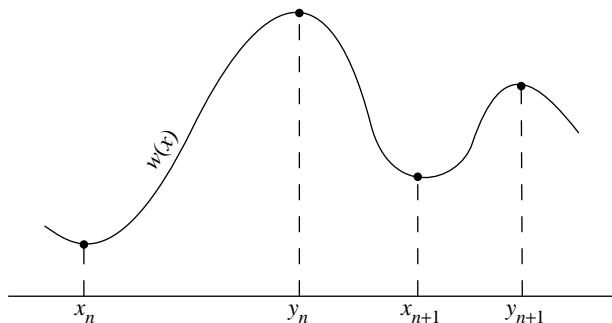

FIGURE 3.3

$w'(x_n) = 0$, $w'(y_n) = 0$, where a minimum is attained at points $x = x_n$ and a maximum at points $x = y_n$,

$$x_n < y_n < x_{n+1} < y_{n+1}.$$

By virtue of Theorem 3.1,

$$w(y_{n+1}) < w(y_n), \quad w(x_{n+1}) > w(x_n)$$

(Figure 3.3). We now let

$$\bar{w} = \lim w(y_n), \quad \underline{w} = \lim w(x_n).$$

For $x_n < x < y_n$, we have

$$(3.7) \quad \frac{1}{2}w'^2(x) - \frac{1}{2}w'^2(x_n) + c \int_{x_n}^x w'^2(s) ds + \int_{w(x_n)}^{w(x)} F(w) dw = 0,$$

and for $y_n < x < x_{n+1}$,

$$\frac{1}{2}w'^2(x) - \frac{1}{2}w'^2(y_n) + c \int_{y_n}^x w'^2(s) ds + \int_{w(y_n)}^{w(x)} F(w) dw = 0.$$

From this we obtain

$$\begin{aligned} \int_{w(x_n)}^{w(x)} F(w) dw &< 0 \quad \text{for } w(x_n) < w(x) < w(y_n), \\ \int_{w(x)}^{w(y_n)} F(w) dw &> 0 \quad \text{for } w(x_{n+1}) < w(x) < w(y_n). \end{aligned}$$

Therefore

$$(3.8) \quad \int_{\underline{w}}^{\bar{w}} F(w) dw = 0, \quad \int_{\underline{w}}^{w_0} F(w) dw \leq 0, \quad \int_{w_0}^{\bar{w}} F(w) dw \geq 0$$

for arbitrary w_0 , $\underline{w} < w_0 < \bar{w}$. From (3.7) we have

$$(3.9) \quad \int_{x_n}^{y_n} w'^2(s) ds \rightarrow 0, \quad n \rightarrow \infty.$$

We introduce functions $p_n(w) = w'(x)$, $w = w(x)$, $x_n \leq s \leq y_n$. Then $p_n(w(x_n)) =$

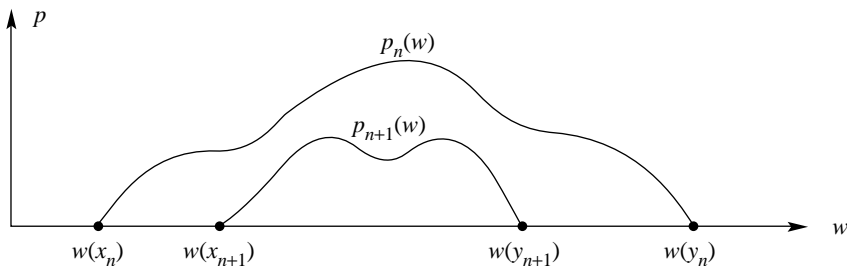

FIGURE 3.4

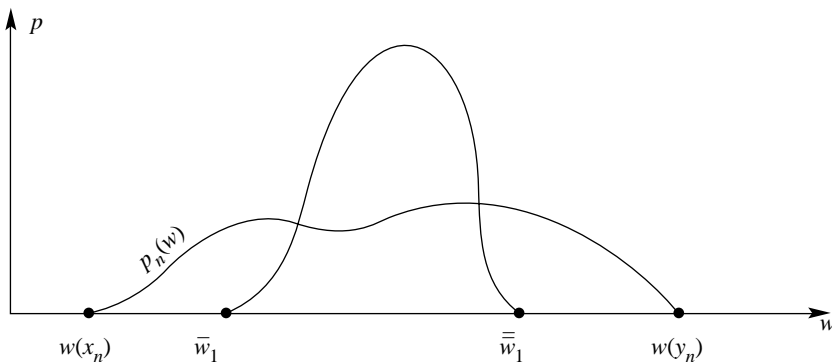

FIGURE 3.5

$p_n(w(y_n)) = 0$, $p_n(w) > 0$ for $w(x_n) < w < w(y_n)$, and $p_{n+1}(w) < p_n(w)$ for $w(x_{n+1}) \leq w \leq w(y_{n+1})$ (Figure 3.4). From (3.9) we have

$$(3.10) \quad \int_{w(x_{n+1})}^{w(y_{n+1})} p_{n+1}(w) dw < \int_{w(x_n)}^{w(y_n)} p_n(w) dw \rightarrow 0, \quad n \rightarrow \infty.$$

If the integrals in (3.8) are not identically zero for $\bar{w} < w_0 < \bar{\bar{w}}$, then values of $\bar{w}_1, \bar{\bar{w}}_1 \in [\bar{w}, \bar{\bar{w}}]$ can be found such that

$$\int_{\bar{w}_1}^{\bar{\bar{w}}_1} F(w) dw = 0, \quad \int_{\bar{w}_1}^{w_0} F(w) dw < 0, \quad \int_{w_0}^{\bar{\bar{w}}_1} F(w) dw > 0 \quad \text{for} \quad \bar{w}_1 < w_0 < \bar{\bar{w}}_1.$$

It follows that there exists a solution $p(w)$ of the equation

$$(3.11) \quad \frac{dp}{dw} = -c - \frac{F(w)}{p}$$

for $c = 0$ such that $p(\bar{w}_1) = p(\bar{\bar{w}}_1) = 0$, $p(w) > 0$ for $\bar{w}_1 < w < \bar{\bar{w}}_1$. Therefore, by virtue of (3.10), for sufficiently large n functions $p(w)$ and $p_n(w)$ have two points of intersection (Figure 3.5). However, it cannot be so since an increase in c results in a decrease of the derivative dp/dw of the solution p of equation (3.11).

Let us assume now that the integrals in (3.8) are identically equal to 0 for $\bar{w} \leq w_0 \leq \bar{\bar{w}}$. This means that $F(w_0) \equiv 0$ for $\bar{w} \leq w_0 \leq \bar{\bar{w}}$. Therefore there exists a solution $p(w)$ of equation (3.11) (for the $c > 0$ considered), having the form $p(w) = -c(w - \bar{w})$. By virtue of (3.10), for large n the graphs of the functions

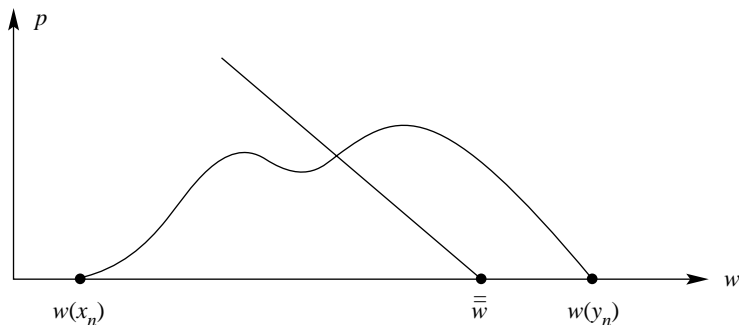

FIGURE 3.6

$p(w)$ and $p_n(w)$ must have a point of intersection, but not coincide identically (Figure 3.6). This contradicts uniqueness of a solution of the Cauchy problem. This contradiction completes the proof of the theorem for $c > 0$. For $c < 0$ the proof is similar (or can be reduced to the preceding proof by a change of variables). This completes the proof of the theorem. \square

COROLLARY 1. For $c \neq 0$ a wave, i.e., a solution of equation (3.1) bounded on the whole axis, has limits at infinity.

COROLLARY 2. For $c > 0$ ($c < 0$) a wave is monotone on some left (right) semiaxis.

COROLLARY 3. For $c \neq 0$, for a nonmonotone wave $w(x)$, one of the two values $\max_x w(x)$, $\min_x w(x)$ is attained at a finite point ($x = x_0$), where the corresponding inequality

$$w(x) < w(x_0) \quad (w(x) > w(x_0)), \quad x \neq x_0,$$

is strict.

COROLLARY 4. For $c \neq 0$, for a nonmonotone wave $w(x)$, the difference $w(x) - w(x - h)$ is a function with alternating sign for arbitrary h , i.e., the inequality

$$w(x) < w(x - h) \quad (w(x) > w(x - h))$$

cannot be satisfied for all x .

REMARK 1. The last assertion turns out to be useful in proving instability of nonmonotone waves (see §5.2).

REMARK 2. The last corollary remains valid even when $c = 0$, with only the reservation that for a periodic wave we can have the identity $w(x) \equiv w(x - h)$.

Let $w(x)$ be a solution of equation (3.1) such that $w(x) > 0$ for $x \geq N$ for some N and $w(x) \rightarrow 0$ as $x \rightarrow \infty$ (later in this section we shall assume that $a = 0$). It then follows from the preceding that $w'(x) < 0$ for sufficiently large x .

From equation (3.1) we obtain

$$(3.12) \quad \frac{w''}{w} + c \frac{w'}{w} \rightarrow -F'(0) = -\alpha,$$

as $x \rightarrow \infty$. If we differentiate equation (3.1), we then obtain, as $x \rightarrow \infty$,

$$(3.13) \quad \frac{w'''}{w'} + c \frac{w''}{w'} \rightarrow -\alpha.$$

We introduce the functions $\varphi_1(x) = w'(x)w^{-1}(x)$, $\varphi_2(x) = w''(x)[w'(x)]^{-1}$. Obviously,

$$\varphi_1'(x) = w''(x)w^{-1}(x) - \varphi_1^2(x), \quad \varphi_2'(x) = w'''(x)[w'(x)]^{-1} - \varphi_2^2(x).$$

From (3.12), (3.13) we obtain

$$(3.14) \quad \varphi_i'(x) + c\varphi_i(x) + \varphi_i^2(x) \rightarrow -\alpha \quad (i = 1, 2)$$

as $x \rightarrow \infty$.

THEOREM 3.3. *As $x \rightarrow \infty$, $\varphi_i(x) \rightarrow \lambda$, where λ is a solution of the equation*

$$(3.15) \quad \lambda^2 + c\lambda + \alpha = 0.$$

PROOF. We show first that $|\varphi_i(x)|$ cannot tend to infinity as $x \rightarrow \infty$. Indeed, let $|\varphi_i(x)| \rightarrow \infty$. Then $\psi(x) = \varphi_i^{-1}(x) \rightarrow 0$ as $x \rightarrow \infty$. Dividing (3.14) by $\varphi_i^2(x)$, we obtain $\psi'(x) \rightarrow 1$ as $x \rightarrow \infty$, which is not possible.

We show that $\varphi_i(x)$ has a finite limit as $x \rightarrow \infty$. Let us assume the contrary. We can then select sequences $\{x_n\}$, $\{y_n\}$, $x_n \rightarrow \infty$, $y_n \rightarrow \infty$, $\varphi_i(x_n) \rightarrow \lambda_1$, $\varphi_i(y_n) \rightarrow \lambda_2$, $\lambda_1 < \lambda_2$. Let λ_0 satisfy the inequality $\lambda_1 < \lambda_0 < \lambda_2$ and not be a solution of equation (3.15). If, for example,

$$\lambda_0^2 + c\lambda_0 + \alpha > 0,$$

then for the sequence $\{z_n\}$, $z_n \rightarrow \infty$, $\varphi(z_n) = \lambda_0$, $\varphi_i'(z_n) \geq 0$, we obtain

$$\varphi_i'(z_n) + c\varphi_i(z_n) + \varphi_i^2(z_n) \geq c\lambda_0 + \lambda_0^2 > -\alpha,$$

which contradicts (3.14).

Thus, $\varphi_i(x) \rightarrow \lambda$ as $x \rightarrow \infty$, whence

$$\varphi_i'(x) \rightarrow -\lambda^2 - c\lambda - \alpha.$$

This limit must be equal to zero in view of the boundedness of $\varphi_i(x)$. This completes the proof of the theorem. \square

COROLLARY 1. *If $F(w) \in C^1[0, 1]$, $w(x) > 0$ for sufficiently large x , and $w(x) \rightarrow 0$ as $x \rightarrow \infty$, then as $x \rightarrow \infty$ we have one of the following relations:*

$$(3.16) \quad \frac{w'}{w} \rightarrow -c/2 + (c^2/4 - \alpha)^{1/2}, \quad \frac{w''}{w'} \rightarrow -c/2 + (c^2/4 - \alpha)^{1/2},$$

$$(3.17) \quad \frac{w'}{w} \rightarrow -c/2 - (c^2/4 - \alpha)^{1/2}, \quad \frac{w''}{w'} \rightarrow -c/2 - (c^2/4 - \alpha)^{1/2},$$

where $\alpha = F'(0)$, $c^2/4 - \alpha \geq 0$.

COROLLARY 2. *If, in the conditions of the preceding corollary, $F(w) \in r^0(0)$ (i.e., there exists a sequence $\{w_n\}$, $w_n \rightarrow 0$, $F(w_n) = 0$), then as $x \rightarrow \infty$,*

$$\frac{w'}{w} \rightarrow -c, \quad \frac{w''}{w'} \rightarrow -c.$$

PROOF. If sequence $\{x_n\}$ is such that $x_n \rightarrow \infty$, $w(x_n) = w_n$, then

$$\frac{w''(x_n)}{w'(x_n)} = -c - \frac{F(w(x_n))}{w'(x_n)} = -c.$$

Since the limit of $w''(x)[w'(x)]^{-1}$ as $x \rightarrow \infty$ exists, it is then equal to $-c$. By L'Hopital's Rule, $w'(x)w^{-1}(x) \rightarrow -c$. This completes the proof of the corollary. \square

THEOREM 3.4. *For existence of a solution $p(u)$ of equation (2.7) such that $p(a) = 0$ and $p(u) < 0$ for $u > a$ close to point a , it is necessary that the inequality*

$$(3.18) \quad c \geq \omega^*(a)$$

be satisfied and sufficient that the inequality

$$(3.19) \quad c > \omega^*(a)$$

be satisfied. If such a solution exists, we then have one of the relations

$$(3.20) \quad \begin{aligned} p'(u) &\rightarrow -c/2 + (c^2/4 - F'(a))^{1/2}, \\ p'(u) &\rightarrow -c/2 - (c^2/4 - F'(a))^{1/2} \end{aligned}$$

for $u \searrow a$, where, for $F'(u) \in r^0(a)$,

$$(3.21) \quad p'(u) \rightarrow -c \quad (u \searrow a).$$

When conditions (3.19) are satisfied, this solution is unique if $F(u) \notin r^+(a)$ or if $F(u) \in r^+(a)$ and the second of conditions (3.20) is satisfied.

PROOF. Necessity of condition (3.18) and sufficiency of condition (3.19) follow from Theorem 2.1. Relations (3.20) and (3.21) follow from Corollaries 1 and 2 of the preceding theorem.

Let $F(u) \in r^-(a)$ and assume that there exist two solutions $p_i(u)$ ($i = 1, 2$) of equation (2.7) satisfying the conditions $p_1(a) = p_2(a) = 0$, $p_i(u) < 0$. We set $p = p_1 - p_2$ and assume, for definiteness, that $p > 0$. We obtain

$$\frac{dp}{du} = k(u)p(u), \quad \text{where} \quad k(u) = \frac{F(u)}{p_1(u)p_2(u)}.$$

It follows that $p'(u)$ and $p(u)$ are of different signs for $u > a$, which is not possible since $p(a) = 0$.

Now let $F(u) \in r^0(a)$ or $F(u) \in r^+(a)$ and let the second of conditions (3.20) be satisfied. As above, let $p = p_1 - p_2$. We have

$$k(u)(u - a) = \frac{F(u)}{u - a} \frac{u - a}{p_1(a)} \frac{u - a}{p_2(a)} \xrightarrow{u \rightarrow a} \frac{F'(a)}{(c/2 + (c^2/4 - F'(a))^{1/2})^2} < 1.$$

From this we have $p'(u) < p(u)(u - a)^{-1}$ for $a < u < u_0$ for some u_0 ; consequently,

$p(u) \geq p(u_0)(u_0 - a)^{-1}(u - a)$, which contradicts the fact that $p(u)(u - a)^{-1} \rightarrow 0$. This completes the proof of the theorem. \square

Similarly, we may prove the following theorem.

THEOREM 3.5. *For existence of a solution $p(u)$ of equation (2.7) such that $p(b) = 0$ and $p(u) < 0$ for $u < b$ close to point b , it is necessary that the inequality*

$$(3.22) \quad c \leq \omega_*(b)$$

be satisfied and sufficient that the inequality

$$(2.23) \quad c < \omega_*(b)$$

be satisfied. If such a solution exists, we then have one of the relations

$$(3.24) \quad \begin{aligned} p'(u) &\rightarrow -c/2 + (c^2/4 - F'(b))^{1/2}, \\ p'(u) &\rightarrow -c/2 - (c^2/4 - F'(b))^{1/2} \end{aligned}$$

as $u \rightarrow b$, where, for $F'(u) \in l^0(b)$,

$$(3.25) \quad p'(u) \rightarrow -c \quad (u \rightarrow b).$$

When condition (3.23) is satisfied, this solution is unique if $F(u) \notin l^-(b)$ or if $F(u) \in l^-(b)$ and the first of conditions (3.24) is satisfied.

COROLLARY. *Let us assume that the following limit exists and is positive:*

$$\alpha_n = \lim F(u)(u - a)^{-n} \quad (n > 1) \quad \text{as } u \searrow a.$$

Then if $c > 0$, and if the first of relations (3.20) holds for a solution of the system

$$u'(x) = p(x), \quad p'(x) = -cp(x) + F(u(x)),$$

then

$$(3.26) \quad u(x) - a \sim c^{1/(n-1)} [a_n(n-1)x]^{1/(n-1)} \quad \text{as } x \rightarrow \infty.$$

PROOF. Since $p'(u) \rightarrow 0$ for $u \searrow a$, then from (2.7) we have $F(u)p^{-1}(u) \rightarrow -c$, and, consequently, $p(u)(u - a)^{-n} \rightarrow -c^{-1}a_n$. From this, by L'Hopital's Rule, as $x \rightarrow \infty$,

$$\lim x(u - a)^{n-1} = \lim (u - a)^n [(1 - n)u'(x)]^{-1} = (n - 1)^{-1}ca_n^{-1},$$

and relation (3.26) follows. \square

3.2. Minimal system of waves. It is convenient to give a definition of a system of waves in terms of solutions of equation (2.7):

$$(3.27) \quad p'(u) + \frac{F(u)}{p(u)} + c = 0.$$

The converse to equation (3.1) is obvious. As above, we assume that $F(a) = F(b) = 0$.

DEFINITION 3.1. We shall say that we are given an $[a, b]$ -system of waves if on the interval $[a, b]$ there is a single-valued continuous function $R(u)$, satisfying conditions:

1. $R(a) = R(b) = 0$, $R(u) \leq 0$ for $a \leq u \leq b$;

2. If $R(u) < 0$ for $a \leq u_1 < u < u_2 \leq b$, $R(u_1) = R(u_2) = 0$, then for some c there exists a solution $p(u)$ of equation (3.27) such that $p(u) = R(u)$ for $u_1 < u < u_2$.

For brevity, in what follows, we shall call $R(u)$ a system of waves.

DEFINITION 3.2. An $[a, b]$ -system of waves $R_0(u)$ is called minimal if for an arbitrary $[a, b]$ -system of waves $R(u)$ we have

$$R_0(u) \leq R(u), \quad a \leq u \leq b.$$

It is convenient to introduce the following notation: $\tau_c(u; u_1, u_2)$ is a solution $p(u)$ of equation (3.27) satisfying the conditions

$$p(u) < 0, \quad u_1 < u < u_2, \quad p(u_1) = p(u_2) = 0.$$

THEOREM 3.6. For an arbitrary source $F(u)$ there exists an $[a, b]$ -minimal system of waves.

PROOF. For each $u_0 \in [a, b]$ let us set

$$R_0(u_0) = \inf\{p \mid \text{for some } c \text{ and } u_1, u_2: a \leq u_1 \leq u_0 \leq u_2 \leq b, \text{ there exists a solution } \tau_c(u; u_1, u_2) \text{ such that } p = \tau_c(u_0; u_1, u_2)\}.$$

If no such solution exists, we set $R_0(u_0) = 0$.

It is sufficient to show that $R(u_0)$ is a system of waves. For this purpose, we use an estimate of $|R_0(u)|$, which follows from the inequality

$$(3.28) \quad \tau_c^2(u; u_1, u_2) \leq 2 \int_a^b |F(u)| du, \quad u \in [u_1, u_2].$$

To prove inequality (3.28) it is sufficient to multiply equation (3.27) by $p(u)$ and integrate from u_1 to u for $c \leq 0$ and from u to u_2 for $c > 0$.

We note the following estimate for a solution $\tau_c(u_0; u_1, u_2)$ of equation (3.27), passing through the point (u_0, p) , $p < 0$:

$$(3.29) \quad |c| \leq |p|^{-1} \max |F(u)|.$$

This follows from the fact that at point $u_* \in (u_1, u_2)$, at which function $\tau_c(u_0; u_1, u_2)$ attains a minimum, we have the equality

$$c = -p^{-1}(u_*)F(u_*).$$

It follows from the theorem concerning the continuous dependence of a solution on parameter c , bounded by virtue of (3.29), and on the initial condition, that for some c_1 there exists a function $\tau_{c_1}(u; a_1, b_1)$ for which

$$R_0(u_0) = \tau_{c_1}(u_0; a_1, b_1), \quad c \leq a_1 < b_1 \leq b.$$

We show that

$$R_0(u) = \tau_{c_1}(u; a_1, b_1), \quad a_1 \leq u \leq b_1.$$

Indeed, if this is not so, then for some $u_1 \in [a_1, b_1]$, for definiteness, $u_1 > u_0$, we have the inequality

$$R_0(u_1) < \tau_{c_1}(u_1; a_1, b_1).$$

We denote by $\tau_{c_2}(u; a_2, b_2)$ a solution for which

$$R_0(u_1) = \tau_{c_2}(u_1; a_2, b_2), \quad a \leq a_2 < b_2 \leq b.$$

Since

$$\tau_{c_2}(u_0; a_2, b_2) \geq \tau_{c_1}(u_0; a_1, b_1),$$

the equation

$$\tau_{c_2}(u; a_2, b_2) = \tau_{c_1}(u; a_1, b_1)$$

then has a solution $u \in [u_1, u_2]$, and, therefore, $a_2 > a_1$. Let $c_3 < c_2$, with c_3 sufficiently close to c_2 . Then there exists a function

$$\tau_{c_3}(u; a_3, b_3), \quad b_3 = b_2, \quad a_3 > a_1,$$

such that

$$(3.30) \quad \tau_{c_3}(u; a_2, b_2) < \tau_{c_2}(u; a_2, b_2), \quad a_2 < u < b_2.$$

Inequality (3.30) contradicts the definition of $R_0(u)$. This completes the proof of the theorem. \square

From the proof of the theorem we obtain the following

COROLLARY. $R_0(u) \leq \tau_c(u; a_1, b_1)$ for $u \in [a_1, b_1]$ for arbitrary c and $a_1, b_1 \in [a, b]$ for which $\tau_c(u; a_1, b_1)$ exists.

THEOREM 3.7. *If $R_0(u)$ is the $[a, b]$ -minimal system of waves, and $R_0(u_0) = 0$ for some $u_0 \in (a, b)$, then $F(u_0) = 0$.*

PROOF. We assume the contrary to be true and, for definiteness, let $F(u_0) > 0$. We denote by (a_1, b_1) an interval such that $F(u) > 0$ for $u \in (a_1, b_1)$, $F(a_1) = F(b_1) = 0$, and $u_0 \in (a_1, b_1)$. By Theorem 2.4, $\omega_*(u_0, b_1) = \infty$, and, by Theorem 2.3, $\omega_*(a_1, b_1) < \infty$. Let $c > \omega_*(a_1, b_1)$. From Theorem 2.2, applied to the interval $[u_0, b_1]$, we conclude that a solution $p(u)$ of equation (3.27) exists, satisfying the conditions $p(u) < 0$ for $u \in [u_0, b_1]$, $p(b_1) = 0$; and this assertion, applied to the interval $[a_1, b_1]$ leads to the equation $p(a_2) = 0$ for some $a_2 \geq a_1$. It follows from this that $R_0(u_0) < 0$, which contradicts our original assumption. If $F(u_0) < 0$, a similar argument can be made. This completes the proof of the theorem. \square

THEOREM 3.8. *Let $\tau_{c_1}(u; a_1, b_1)$ belong to the $[a, b]$ -minimal system of waves. Then*

$$(3.31) \quad c_1 = \omega^*(a_1, v) = \omega_*(u, b_1)$$

for all u, v : $a \leq u \leq a_1$, $b_1 \leq v \leq b$.

PROOF. We show first that

$$(3.32) \quad c_1 \leq \omega_*(a_1, b_1).$$

Let c be arbitrary: $c < c_1$. Then, by the usual method (see, for example, Theorem 2.1), it may be proved that there exists a solution $p(u)$ of equation (3.27) such that

$$p(b_1) = 0, \quad p(u) \leq \tau_{c_1}(u; a_1, b_1) \quad \text{for } u \in [a_1, b_1],$$

where, for at least one point u , the inequality is strict, since $c \neq c_1$. We have $p(a_1) < 0$; otherwise, $\tau_{c_1}(u; a_1, b_1)$ would not belong to a minimal system of waves. By virtue of Theorem 2.2 we find that $c \leq \omega_*(a_1, b_1)$, whence (3.32) follows in view of the arbitrariness of c .

In exactly the same way we can show that

$$(3.33) \quad c_1 \geq \omega^*(a_1, b_1).$$

From this we find, using (3.32) and (2.18), that

$$(3.34) \quad c_1 = \omega_*(a_1, b_1) = \omega^*(a_1, b_1).$$

It is now necessary for us to show that

$$(3.35) \quad \omega_*(u, b_1) = \omega_*(a_1, b_1)$$

for all $a \leq u \leq a_1$. Let us assume the contrary:

$$(3.36) \quad \omega_*(u_1, b_1) < \omega_*(a_1, b_1)$$

for some $u_1 \in [a, a_1]$. Then, taking c between the values indicated in (3.36), we obtain, by virtue of Theorem 2.2 applied to the interval $[a_1, b_1]$, that there exists a solution of equation (3.27), satisfying the condition $p(u) < 0$ for $u \in [a_1, b_1]$, $p(b_1) = 0$, and, by the same proposition applied to the interval $[u_1, b_1]$, we find that a continuation of this solution must vanish on the interval $[u_1, a_1]$. But this contradicts the fact that $\tau_{c_1}(u; a_1, b_1)$ belongs to the minimal system of waves. In a similar way we may prove equality (3.31) for ω^* . This completes the proof of the theorem. \square

COROLLARY. *Let $\tau_{c_1}(u; a_1, b_1)$ and $\tau_{c_2}(u; a_2, b_2)$ be two waves from the minimal system of waves. Then $c_1 \geq c_2$ if $b_1 \leq a_2$.*

PROOF. On the basis of Theorem 3.8,

$$c_1 = \omega^*(a_1, b_2), \quad c_2 = \omega_*(a_1, b_2).$$

It remains now to apply inequality (2.18).

We assume that in the system of waves considered there is a right wave and a left wave, i.e., waves $\tau_{c_1}(u; a_1, b)$ and $\tau_{c_2}(u; a, b_1)$. It then follows from the results presented above that $\omega_*(a, b) = c_1$ and $\omega^*(a, b) = c_2$. Thus we have arrived at the following interpretation of the functionals introduced in §2: $\omega^*(a, b)$ and $\omega_*(a, b)$ are the speeds of the left and right waves from the $[a, b]$ -minimal system of waves. In particular, it follows that if $\omega^*(a, b) = \omega_*(a, b)$, then all waves from the minimal system have identical speeds.

The assumption about the presence of a right wave and a left wave is essential from the point of view of applications: its nonfulfillment means that either an infinite number of waves or an interval of degenerate waves from the minimal system about point a or point b . \square

3.3. Existence of waves. We now obtain conditions for the existence of waves. Here, and in what follows, we discuss $[a, b]$ -waves $w(x)$ that satisfy the condition $a \leq w(x) \leq b$, and, consequently, by the results of §3.1, monotonically decrease.

THEOREM 3.9. *For the existence of solutions of problem (3.1), (3.2) it is necessary that at least one of the inequalities*

$$(3.37) \quad \int_a^u F(s) ds < 0,$$

$$(3.38) \quad \int_u^b F(s) ds > 0$$

is satisfied for all $u \in (a, b)$. For the case in which inequality (3.37) is satisfied, $c \leq 0$; in the case of inequality (3.38), $c \geq 0$. The simultaneous satisfaction of inequalities (3.37) and (3.38) for all $u \in (a, b)$ is a necessary and sufficient condition for the existence of a wave with speed c equal to zero.

PROOF. Multiplying equation (3.27) by $p(u)$ and integrating, we obtain, for $u \in (a, b)$,

$$(3.39) \quad \int_a^u F(s) ds = -c \int_a^u p(s) ds - \frac{1}{2}p^2(u),$$

$$(3.40) \quad \int_u^b F(s) ds = -c \int_u^b p(s) ds + \frac{1}{2}p^2(u).$$

For $c \leq 0$, from (3.39) we obtain (3.37); for $c \geq 0$, from (3.40) we obtain (3.38); for $c = 0$, both inequalities are valid.

When both inequalities (3.37) and (3.38) are satisfied,

$$c = \int_a^b F(u) du = 0,$$

and existence of a solution of problem (3.27), with $p(a) = p(b) = 0$, is obtained in this case through explicit construction. From (3.40) it follows that

$$(3.41) \quad p(u) = -\left(2 \int_u^b F(s) ds\right)^{1/2}.$$

This completes the proof of the theorem. \square

When $c \neq 0$, the conditions we have given are not sufficient, as simple examples show. Necessary and sufficient conditions for the existence of a wave when $c \neq 0$ are obtained in terms of the functionals ω_* and ω^* .

THEOREM 3.10. *For the existence of an $[a, b]$ -wave with positive speed c , the following conditions are necessary and sufficient:*

1. $F(u) > 0$ for $u < b$ close to b ;
- (3.42) 2. $\int_a^b F(u) du > 0$;
3. $\omega^*(a, u) < \omega_*(u, b)$ for all $u \in (a, b)$.

PROOF. *Necessity.* Condition 1 follows from (3.38), since $F(u) \in l^0(b)$ would imply (3.25), which is not possible for $c > 0$. Condition 2 is obtained from (3.39) for $u = b$.

We now show that condition 3 holds. Indeed, by virtue of Theorem 2.1, we have $\omega^*(a, u) \leq c$, and, by virtue of Theorem 2.7, the inequality $c < \omega_*(u, b)$ is satisfied, from which the inequality in question follows.

Sufficiency. Consider the $[a, b]$ -minimal system of waves. It follows from condition 1 that it contains a right wave. Let it be a $[d, b]$ -wave. If $d > a$, we then select number c : $\omega^*(a, d) < c < \omega_*(d, b)$. It follows from Theorem 2.1 that a solution $p_c(u)$ of equation (2.7) exists, satisfying the conditions: $p_c(a) = 0$, $p_c(u) < 0$ for $u \in (a, d]$. We construct solution $p(u)$ of equation (2.7), satisfying condition $p(b) = 0$. Moreover, for c sufficiently close to $\omega_*(d, b)$, we will have $p_c(d) < p(d) < 0$. Consequently, a continuation of solution $p(u)$ vanishes for some $u \in [a, d)$, which contradicts the corollary to Theorem 3.6. Thus, we have proved the existence of an $[a, b]$ -wave. Positiveness of its speed follows from condition 2. The theorem is thereby proved. \square

REMARK. If it is known that an $[a_1, b]$ -wave exists, where a_1 is some number, $a < a_1 < b$, then for existence of an $[a, b]$ -wave it is sufficient that condition 3 of the theorem be satisfied for $u \in (a, a_1]$. Indeed, in this case the $[a, b]$ -minimal system of waves contains a $[d, b]$ -wave, where $a \leq d \leq a_1$, and further discussion proceeds as in the proof of the theorem.

THEOREM 3.11. *For existence of an $[a, b]$ -wave with negative speed c , satisfaction of the following conditions is necessary and sufficient:*

1. $F(u) < 0$ for $u > a$ close to a ;
2. $\int_a^b F(u) du < 0$;
3. $\omega^*(a, u) < \omega_*(u, b)$ for all $u \in (a, b)$.

The proof of this theorem is similar to the proof of Theorem 3.10.

THEOREM 3.12. *For existence of an $[a, b]$ -wave with positive speed c , it is necessary and sufficient that the following condition be satisfied:*

$$(3.43) \quad 0 < \omega_*(a, b) < \omega_*(u, b) \quad \text{for all } u \in (a, b).$$

PROOF. *Necessity.* Assume that an $[a, b]$ -wave exists with speed $c > 0$. Then there exists a minimal wave with speed $c_* = \omega_*(a, b) > 0$. Since condition (3.42) is satisfied, then, applying Theorem 2.7 with $c = c_*$ to the interval $[u, b]$, we obtain $c_* < \omega_*(u, b)$.

Sufficiency. Let $\omega_*(a, b) < c < \omega_*(\bar{u}, b)$, where $\bar{u} \in (a, b)$. It then follows from the inequality on the right that on the interval $[\bar{u}, b]$ there exists a solution $p(u)$ of problem (2.7) with the conditions $p(b) = 0$, $p(u) < 0$ for $u \in [\bar{u}, b)$. By virtue of the inequality $\omega_*(a, b) < c$, $p(u_1) = 0$ for $a \leq u_1 < \bar{u}$. Since $\bar{u} \in (a, b)$ is arbitrary, the minimal system of waves on the interval $[a, b]$ consists of a single wave. This completes the proof of the theorem. \square

A similar result holds also for negative speeds.

THEOREM 3.13. *Assume that $[a, a_1]$ - and $[b_1, b]$ -waves exist, where $a < a_1 \leq b_1 < b$. If the condition*

$$(3.44) \quad \omega^*(a, u) < \omega_*(u, b)$$

is satisfied for $a_1 \leq u \leq b_1$, then an $[a, b]$ -wave exists.

PROOF. We consider the $[a, b]$ -minimal system of waves. If it does not consist of a single $[a, b]$ -wave, then it contains $[b_2, b]$ - and $[a, a_2]$ -waves, where $a_1 \leq a_2 \leq b_2 \leq$

b_1 . On the basis of Theorem 3.8 and inequality (3.44) we have $\omega_*(b_2, b) = \omega_*(a_2, b) > \omega^*(a, a_2)$, which contradicts the corollary to Theorem 3.8. This completes the proof of the theorem. \square

We have obtained conditions for the existence of waves. We now pose the problem of classifying all existing $[a, b]$ -waves. The following lemma shows that non-uniqueness of a wave is possible only at the expense of different c values.

LEMMA 3.1. *Equation (2.7), with c given, can have no more than one solution $p(u)$: $p(u) < 0$ for $u \in (a, b)$, if $c \geq 0$ and $p(b) = 0$, or if $c \leq 0$ and $p(a) = 0$.*

PROOF. Let us assume that $c \geq 0$ and that there exist two different solutions of the type indicated, $p(u)$ and $p_1(u)$. Then from (2.7) we have

$$(3.45) \quad \frac{1}{2}[p_1^2(u) - p^2(u)] = c \int_u^b [p_1(s) - p(s)] ds.$$

Since $p_1(u) \neq p(u)$ for all $u \in (a, b)$, we obtain a contradiction in signs in (3.45). Indeed, if, for example, $p_1(u) > p(u)$, then the right-hand side in (3.45) is non-negative while the left-hand side is negative. For $c \leq 0$ the proof is similar. This completes the proof of the lemma. \square

Let

$$\omega_*(a+0, b) = \lim_{u \searrow a} \omega_*(u, b), \quad \omega^*(a, b-0) = \lim_{u \nearrow b} \omega^*(a, u).$$

THEOREM 3.14. 1. *For a source of Type A: if an $[a, b]$ -wave exists, it is unique and its speed c may be calculated from the expression*

$$(3.46) \quad c = \omega_*(a, b) = \omega^*(a, b).$$

2. *For a source of Type B: if an $[a, b]$ -wave exists, then its speed $c \neq 0$. If point a is unstable, we then have the inequality*

$$(3.47) \quad 0 < \omega_*(a, b) < \omega_*(a+0, b),$$

and a wave exists for those, and only those, speeds c which satisfy the inequality

$$(3.48) \quad \omega_*(a, b) \leq c < \omega_*(a+0, b).$$

If point b is unstable, then

$$\omega^*(a, b-0) < \omega^*(a, b) < 0,$$

and a wave exists for those, and only those, speeds c which satisfy the inequality

$$\omega^*(a, b-0) < c \leq \omega^*(a, b).$$

3. *For a source of Type C a wave does not exist.*

PROOF. 1. From the existence of a wave it follows that a minimal system of waves consists of a single wave, and, according to Theorem 3.8, its speed is calculated from (3.46). By the preceding lemma, for a given c the wave is unique. Assume now that a wave exists with speed $c_1 \neq c$. Let us assume that $c_1 > c$. Then $c_1 > \omega^*(a, b)$ and, according to Theorem 2.1, there exists a solution $p(u)$ of equation (2.7) with $c = c_1$, satisfying the conditions

$$p(a) = 0, \quad p(u) < 0 \quad \text{for } u \in (a, b].$$

Thus, for $c = c_1$ there exist two solutions of equation (2.7) with the conditions

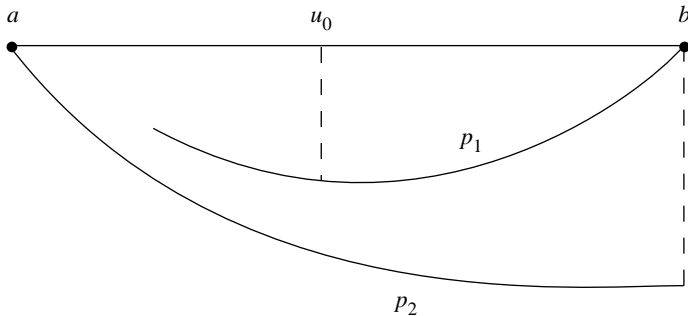

FIGURE 3.7

$p(a) = 0$, $p(u) < 0$, $u > a$ close to point a : the indicated solution with $p(b) < 0$ and the wave with $p(b) = 0$. But, by virtue of the inequality $\omega^*(a, b) \geq \omega^*(a)$, where $\omega^*(a) = \lim \omega^*(a, u)$ as $u \rightarrow a$, this contradicts the assertion concerning uniqueness in Theorem 3.4. For $c_1 < c$ the reasoning is similar.

2. For a source of Type B both conditions (3.37) and (3.38) cannot be satisfied simultaneously. Therefore a wave with zero speed cannot exist.

Let us suppose that point a is unstable. Then if an $[a, b]$ -wave exists, its speed, by virtue of (3.38), is positive. In particular, the speed $c_* = \omega_*(a, b)$ of the minimal wave is positive. Let $F(u) > 0$ for $a < u < u_0$, $F(u_0) = 0$. We assume that $u_0 < b$. The situation is simpler in case $u_0 = b$. We have $\omega_*(a, b) \leq \omega_*(u_0, b)$ by virtue of the monotonicity of function $\omega_*(u, b)$ with respect to u . We show that the equality sign is not possible here. Indeed, suppose that $\omega_*(a, b) = \omega_*(u_0, b)$. Consider now a right wave in a $[u_0, b]$ -system of waves, which exists by virtue of inequality (3.42). Its speed is equal to $\omega_*(u_0, b)$. This is also the speed of the minimal $[a, b]$ -wave contradicting the uniqueness assertion in Theorem 3.5. Thus, we have shown that $\omega_*(a, b) < \omega_*(u_0, b)$.

Based on the corollary to Theorem 2.8, we have

$$(3.49) \quad \omega_*(u_1, b) = \omega_*(a + 0, b),$$

for all $a < u_1 \leq u_0$.

Since, by assumption, an $[a, b]$ -wave exists, the minimal $[a, b]$ -system of waves consists of a single wave, whose speed, by Theorem 3.8, is equal to

$$(3.50) \quad \omega_*(a, b) = \omega^*(a, b).$$

Thus, a wave exists for $c = \omega_*(a, b)$.

We show that for arbitrary c satisfying the inequality

$$(3.51) \quad \omega_*(a, b) < c < \omega_*(u_0, b) = \omega_*(a + 0, b),$$

an $[a, b]$ -wave exists. Indeed, by virtue of the second inequality in (3.51), a solution $p_1(u)$ of equation (2.7) exists, satisfying the conditions $p_1(b) = 0$, $p_1(u) < 0$ for $u_0 \leq u < b$ (Figure 3.7). By virtue of the first inequality in (3.51) and equation (3.50), a solution $p_2(u)$ of equation (2.7) exists, satisfying conditions $p_2(a) = 0$, $p_2(u) < 0$ for $a < u \leq b$, so that $p_1(u) > p_2(u)$. We extend solution $p_1(u)$ for $u < u_0$. On the basis of (3.49), $p_1(u) < 0$ for $a < u < u_0$, by virtue of Theorem 2.2 and Lemma 3.1. Consequently, $p_1(a) = 0$. Thus we have established the existence of a wave for all c satisfying inequality (3.51).

We show now that an $[a, b]$ -wave exists only for those c which satisfy inequality (3.48). It is sufficient to show that if a wave with speed c exists, then $c < \omega_*(a+0, b)$. Let $c > \omega_*(u_0, b)$. We then obtain a contradiction with Theorem 2.2, applied to the interval $[u_0, b]$. If $c = \omega_*(u_0, b)$, this is then the speed of an $[a, b]$ -wave and also of a right wave in the minimal $[u_0, b]$ -system of waves, which contradicts Lemma 3.1. Thus the theorem is proved for the case in which point a is unstable. A similar treatment can be applied to the case in which point b is unstable.

3. In the case of a source of Type C, the necessary conditions for existence of a wave, presented in Theorem 3.9, are not satisfied. \square

3.4. Minimal c -system of waves. Let us assume that the source $F(u)$ satisfies the conditions:

$$F(u_0) = 0, \quad F(u) > 0 \quad \text{for} \quad u \in (a, u_0),$$

where u_0 is some number: $a < u_0 \leq b$.

For a given number c we define a c -system of waves $R(u; c)$ as a system of waves for which a left wave exists and has speed c .

A c -system of waves $R_0(u; c)$ is said to be minimal if for an arbitrary c -system of waves $R(u; c)$ we have the inequality:

$$(3.52) \quad R_0(u; c) \leq R(u; c) \quad \text{for} \quad u \in [a, b].$$

THEOREM 3.15. *For an arbitrary number c with*

$$(3.53) \quad \omega^*(a, b) \leq c < \infty,$$

there exists a minimal c -system of waves $R_0(u; c)$,

$$R_0(u; c) = \tau_c(u; a, u_1) \quad \text{for} \quad u \in [a, u_1],$$

where $u_1 \in (a, b]$ is the largest number for which $\tau_c(u; a, u_1)$ exists.

If $u_1 < b$, then $R_0(u; c)$ for $u \in [u_1, b]$ is the minimal system of waves on this interval.

PROOF. For $c = \omega^*(a, b)$ the minimal system of waves on the interval $[a, b]$ is a c -minimal system. Consider the case

$$(3.54) \quad c > \omega^*(a, b).$$

We construct $R_0(u; c)$ as indicated in the statement of the theorem. It is easy to see that $F(u_1) = 0$. We need to prove inequality (3.52). It is sufficient to prove that

$$\tau_c(u; a, u_1) \leq R(u; c) \quad \text{for} \quad u \in [a, u_1].$$

Let us assume the contrary. Then in the system of waves $R(u; c)$ there is a wave $\tau_{c_1}(u; a_1, b_1)$ such that $a_1 < u_1 < b_1$,

$$\tau_{c_1}(u_2; a_1, b_1) = \tau_c(u_2; a, u_1),$$

where $u_2 \in (a, u_1)$ (see Figure 3.8). We have the inequality $c_1 > c$; otherwise the indicated intersection of curves would not be possible. Let $p(u)$ be a solution of equation (2.7) for which $p(b_1) = 0$ and for which, by virtue of the relation $c < c_1$, we have the inequality

$$p(u) < \tau_{c_1}(u; a_1, b_1) \quad \text{for} \quad u \in [u_2, b_1].$$

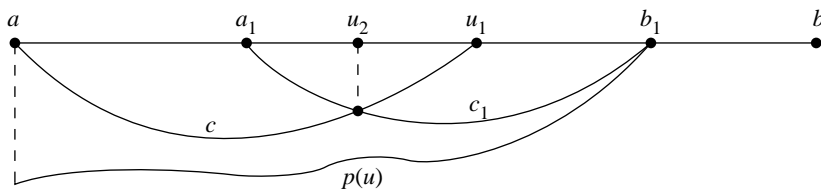

FIGURE 3.8

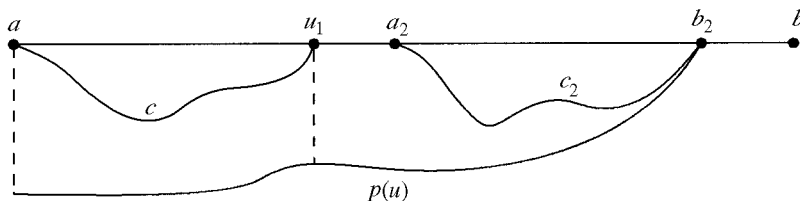

FIGURE 3.9

Since $p(u)$ is continued to the left, it obviously satisfies inequality $p(u) < \tau_c(u; a, u_1)$. From this, by virtue of Theorem 2.2, we have $c \leq \omega_*(a, b_1)$. We have arrived at a contradiction with inequality (3.54), since

$$\omega_*(a, b_1) \leq \omega_*(a, b) \leq \omega^*(a, b).$$

This completes the proof of the theorem. \square

THEOREM 3.16. *Let functions $\tau_{c_i}(u; a_i, b_i)$, $i = 1, 2$, belong to a minimal c -system of waves, $c \geq \omega^*(a, b)$. Then if $b_1 \leq a_2$, it follows that $c_1 \geq c_2$.*

PROOF. By the corollary to Theorem 3.8, it is sufficient to consider the case

$$c > \omega^*(a, b), \quad c_1 = c, \quad a_1 = a, \quad b_1 = u_1.$$

Let us assume that the theorem is not true: $c_2 > c$. Then $c_2 = \omega_*(u_1, b_2)$ (see Theorem 3.8). Since $c < c_2$, there exists a solution $p(u)$ of equation (2.7), satisfying the conditions $p(b_2) = 0$, $p(u) < 0$ for $u \in [u_1, b_2)$, on the basis of Theorem 2.2. Extending it to the left, we obtain $p(u) < 0$ for $u \in [a, b_2)$ (see Figure 3.9). We note that $p(a) < 0$ by the definition of number u_1 in the statement of Theorem 3.15. Consequently,

$$c \leq \omega_*(a, b_2) \leq \omega^*(a, b_2) \leq \omega^*(a, b),$$

and we have a contradiction. This completes the proof of the theorem. \square

THEOREM 3.17. *If $c_1 > c_2 \geq \omega^*(a, b)$, then*

$$R_0(u; c_1) \geq R_0(u; c_2) \quad \text{for } u \in [a, b].$$

PROOF. We can assume that $c_2 > \omega^*(a, b)$, since in the case of equality, $R_0(u, c_2)$ is the minimal system of waves.

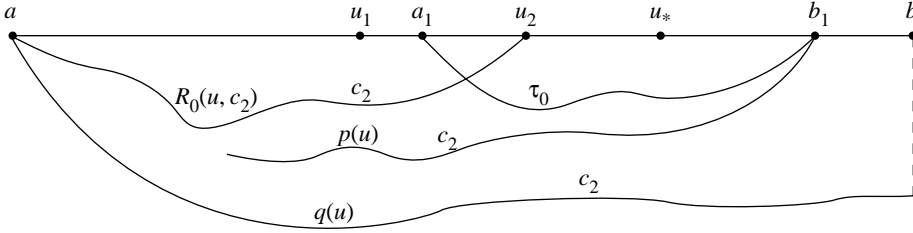

FIGURE 3.10

Let $\tau_{c_i}(u; a, u_i)$, $i = 1, 2$, be left waves belonging to $R_0(u; c_i)$. We show that $u_1 \leq u_2$. Indeed, let us assume the contrary: $u_1 > u_2$. Let $p(u)$ be a solution of equation (2.7) for $c = c_2$, satisfying the condition $p(u_1) = 0$. Moreover, the inequality $p(u) \leq \tau_{c_1}(u; a, u_1)$ will also be satisfied, since $c_2 < c_1$. Further, by virtue of the inequality $c_2 > \omega^*(a, b)$, there exists a solution $p(u) = q(u)$ of equation (2.7) for $c = c_2$, satisfying the conditions

$$q(a) = 0, \quad q(u) < 0 \quad \text{for } u \in (a, b]$$

(see Figure 3.10). It follows from this that $p(a) = 0$, which contradicts the fact that $R_0(u; c_2)$ is a minimal c_2 -system of waves.

If $u_1 = u_2$, then

$$\tau_{c_1}(u; a, u_1) \geq \tau_{c_2}(u; a, u_2)$$

for $a \leq u \leq u_1$, while for $u_1 \leq u \leq b$,

$$R_0(u; c_1) = R_0(u; c_2)$$

since this is the minimal system of waves.

We consider the case $u_1 < u_2$. If, for some u^* , $R_0(u^*; c_1) < R_0(u^*; c_2)$, we then denote by $\tau_c(u; a_1, b_1)$ a function belonging to the system $R_0(u; c_1)$ for which $u^* \in (a_1, b_1)$. Then $a_1 < u_2$, since otherwise $R_0(u; c_2)$ would not be the minimal system of waves on the interval $[u_2, b]$; $u_2 < b_1$. Noting that $c > c_2$, we carry out constructions precisely as we did in the preceding portion of the proof, i.e., we construct a function $p(u)$ for which $p(b_1) = 0$, etc. (see Figure 3.10), and we arrive at a contradiction. This completes the proof of the theorem. \square

THEOREM 3.18. *If $c \geq \omega^*(a, b)$, $c_0 \geq \omega^*(a, b)$, and $c \rightarrow c_0$, then*

$$R_0(u; c) \rightarrow R_0(u; c_0),$$

uniformly with respect to u .

PROOF. It is sufficient to consider the cases $c > c_0$ and $c < c_0$ individually. In the first case we denote by $\tau_c(u; a, b_1)$ and $\tau_{c_0}(u; a, b_0)$ left waves of the systems $R_0(u; c)$ and $R_0(u; c_0)$, respectively. For c sufficiently close to c_0 we have $b_1 = b_0$, since, by virtue of Theorem 3.14, a wave exists for a half-interval of speeds and, therefore, for $c > c_0$ and sufficiently close to c_0 , an $[a, b_0]$ -wave exists. Moreover, $\tau_c(u; a, b_0)$ is close to $\tau_{c_0}(u; a, b_0)$, uniformly with respect to u . For $u > b_0$, $R_0(u; c)$ and $R_0(u; c_0)$ coincide as minimal systems of waves.

For $c \nearrow c_0$, $R_0(u; c) \leq R_0(u; c_0)$ and increases with c , and therefore has a limit, which we denote by $G(u)$. Obviously, $G(u) \leq R_0(u; c_0)$ and is a c_0 -system of waves. Consequently, $G(u) = R_0(u; c_0)$ since $R_0(u; c_0)$ is a minimal c_0 -system of waves. Thus the theorem is proved. \square

Minimal c -systems of waves were introduced above for sources of the second type on the interval $[a, b]$ (monostable case) for the case in which point a is unstable. It is obvious that for the second case, where point b is unstable, all definitions and proofs are analogous.

For sources of the third type, wherein points a and b are unstable, it is necessary to introduce somewhat more complex systems of waves, which we refer to as minimal c^\pm -systems. They differ from minimal c -systems in that for them we are given not only the speed of the wave abutting point $a(c^+)$, but also the speed of the wave abutting point $b(c^-)$. If we denote the speeds of these waves in the minimal system of waves by c_0^+ and c_0^- , then the minimal c^\pm -systems of waves will exist for $c^+ \geq c_0^+$ and $c^- \leq c_0^-$.

§4. Properties of solutions of parabolic equations

4.1. Existence of solutions of the Cauchy problem and behavior of solutions as $x \rightarrow \infty$. We consider the Cauchy problem for the quasilinear equation

$$(4.1) \quad \frac{\partial v}{\partial t} = \frac{\partial^2 v}{\partial x^2} + F(x, t, v),$$

$$(4.2) \quad v(x, 0) = f(x),$$

where $F(x, t, v)$ is a bounded continuous function, given for all real $x, v, t \geq 0$, and satisfying a Lipschitz condition with respect to v and x ; $f(x)$ is a bounded piecewise-continuous function with a finite number of points of discontinuity. We shall assume that at each discontinuity point x_0 the following limiting values exist:

$$f_+(x_0) = \lim_{x \searrow x_0} f(x), \quad f_-(x_0) = \lim_{x \nearrow x_0} f(x).$$

We have the following theorem concerning nonlocal existence of solutions of problem (4.1), (4.2) [**Kolm 1**].

THEOREM 4.1. *There exists one and only one function $v(x, t)$, bounded for bounded values of t , which for $t > 0$ satisfies equation (4.1) and, for $t = 0$, is equal to $f(x)$ at all points of continuity of this function.*

More general results are known concerning nonlocal existence of solutions of the Cauchy problem; however, this theorem is sufficient for what follows. We remark that throughout this chapter our concern is with the existence of a classical solution, i.e., we assume that it has continuous derivatives with respect to x up to the second order inclusive, and a continuous first order derivative with respect to t in an arbitrary domain, where it is defined (but not necessarily in its closure) and continuous up to the boundary of the domain of definition at those points where the corresponding boundary (initial) functions are continuous. A proof of this theorem, and also a proof of Theorem 4.2, is given in Chapter 5 for systems of equations.

THEOREM 4.2. *Let us assume that the limits*

$$\lim_{x \rightarrow \pm\infty} f(x), \quad \lim_{x \rightarrow \pm\infty, v \rightarrow v_0} F(x, t, v)$$

exist for arbitrary fixed values v_0 and $t > 0$. Then the function $v_{\pm}(t) = \lim_{x \rightarrow \pm\infty} v(x, t)$ is defined and satisfies the equation

$$\frac{dv_{\pm}}{dt} = F(\pm\infty, t, v_{\pm}), \quad v_{\pm}(0) = f(\pm\infty).$$

The following theorem concerns a solution of the Cauchy problem

$$(4.3) \quad \frac{\partial u}{\partial t} = \frac{\partial^2 u}{\partial x^2} + F(u),$$

$$(4.4) \quad u(x, 0) = f(x).$$

Later in this section we assume that $F(u) \in C^2[0, 1]$,

$$F(0) = F(1) = 0,$$

$0 \leq f(x) \leq 1$ for all x , and we shall use the notation $\alpha = F'(0)$.

In the following two theorems we assume that $f(x) \rightarrow 0$ as $x \rightarrow \infty$.

THEOREM 4.3. *Let k and c be given real numbers, and let λ be a real root of the equation $\lambda^2 - c\lambda + \alpha = 0$. If $f(x)e^{\lambda x} \rightarrow k$ as $x \rightarrow \infty$, then for each $t > 0$, $u(x + ct, t)e^{\lambda x} \rightarrow k$ as $x \rightarrow \infty$.*

PROOF. Let us set

$$u_1(x, t) = u(x + ct, t)e^{\lambda x}, \quad u_2(x, t) = u_1(x - (c - 2\lambda)t, t).$$

Then function $u_2(x, t)$ satisfies the equation

$$\frac{\partial u_2}{\partial t} = \frac{\partial^2 u_2}{\partial x^2} + \left(\lambda^2 - c\lambda + \frac{F(u)}{u} \right) u_2, \quad u_2(x, 0) = f(x)e^{\lambda x}.$$

According to Theorem 4.2, $u_2(x, t) \rightarrow k$ as $x \rightarrow \infty$, whence $u_1(x, t) \rightarrow k$. This completes the proof of the theorem. \square

COROLLARY 1. *If $f(x)e^{\lambda x} \rightarrow k$ as $x \rightarrow \infty$ for some λ , then $u(x, t)e^{\lambda x} \rightarrow ke^{(\lambda^2 + \alpha)t}$ as $x \rightarrow \infty$.*

The proof is obvious.

COROLLARY 2. *If $(\ln f(x))/x \rightarrow -\lambda$ as $x \rightarrow \infty$, then $(\ln u(x, t))/x \rightarrow -\lambda$ as $x \rightarrow \infty$.*

COROLLARY 3. *If $f(x) = 0$ for $x \geq x_0$ for some x_0 , then $(\ln u(x, t))/x \rightarrow -\infty$ as $x \rightarrow \infty$.*

A proof of the last two corollaries may be obtained from estimates of the function $f(x)$ and, consequently, of the solution $u(x, t)$ in terms of an exponentially decreasing function.

Later in this subsection we assume that $f(x)$ has a continuous first derivative. In this case it is easily verified that function $\omega(x, t) = u'(x, t)$ is a solution of the Cauchy problem

$$\begin{aligned} \frac{\partial \omega}{\partial t} &= \frac{\partial^2 \omega}{\partial x^2} + F'(u)\omega, & \omega(x, 0) &= f'(x) \\ (F'(u) &= dF/du, & u' &= \partial u/\partial x). \end{aligned}$$

The proof of the following theorem is similar to that of Theorem 4.3.

THEOREM 4.4. *Let $f'(x)e^{\lambda x} \rightarrow k$ as $x \rightarrow \infty$, and let $\lambda^2 - c\lambda + \alpha = 0$. Then, for each fixed value of t , $u'(x + ct, t)e^{\lambda x} \rightarrow k$ as $x \rightarrow \infty$.*

COROLLARY 1. *If $f'(x)e^{\lambda x} \rightarrow k$ as $x \rightarrow \infty$, then $u'(x, t)e^{\lambda x} \rightarrow ke^{(\lambda^2 + \alpha)t}$ as $x \rightarrow \infty$.*

COROLLARY 2. *If $f(x)e^{\lambda x} \rightarrow k$, $f'(x)/f(x) \rightarrow -\lambda$ as $x \rightarrow \infty$, then, for each fixed value of t , $u'(x, t)/u(x, t) \rightarrow -\lambda$ as $x \rightarrow \infty$.*

The proof of these corollaries is obvious.

Here we have considered the behavior of solutions as $x \rightarrow \infty$ in some detail since, in many cases, it determines the behavior of solutions as $t \rightarrow \infty$.

4.2. Positiveness and the set of zeros of solutions of a linear equation.

In this subsection we consider the linear equation

$$(4.5) \quad Lv = 0,$$

where

$$(4.6) \quad Lv = \frac{\partial v}{\partial t} - \frac{\partial^2 v}{\partial x^2} - a(x, t) \frac{\partial v}{\partial x} - b(x, t)v.$$

Equation (4.5) will be considered in a domain D of the (x, t) -plane lying in the strip $0 < t < T$. Functions $a(x, t)$ and $b(x, t)$ are assumed to be given in D , and, along with the derivative $\partial a/\partial x$, are assumed to be bounded and continuous in domain D . We present some theorems on positiveness of solutions of equation (4.5), necessary for what follows, and we then use them to study sets of zeros of solutions of this equation.

We denote by Γ a part of the boundary of domain D lying in the strip $0 < t < T$, and by Γ_T an interval belonging to the boundary of domain D and lying on the line $t = T$. Next, following [Fri 1], for an arbitrary point $P_0 = (x^0, t^0) \in D + \Gamma_T$, we denote by $S(P_0)$ a set of points Q in $D + \Gamma_T$, such that they can be joined with P_0 by a simple continuous curve lying in $D + \Gamma_T$ along which coordinate t does not decrease from Q to P_0 . As for $v(x, t)$, we assume that it is a bounded function in D , which, together with its derivatives up to the second order with respect to x and up to the first order with respect to t , is continuous in $D + \Gamma_T$.

THEOREM 4.5. *If $v \geq 0$ ($v \leq 0$) in $S(P_0)$, $Lv \geq 0$ ($Lv \leq 0$) in $S(P_0)$, and $v(P_0) = 0$, then $v \equiv 0$ in $S(P_0)$.*

A proof of this theorem is given in [Fri 1].

Let Γ_0 be the intersection of the closure \overline{D} of domain D with the axis $t = 0$. As for function v , we assume, in addition, that it is continuous in \overline{D} , except possibly

in a set of points on Γ_0 of H -measure 0. Here H is one-dimensional Hausdorff measure.

LEMMA 4.1. *Let D be a bounded set, let $Lv \leq 0$ in D , and let $v(P_0) > 0$ at some point $P_0 = (x_0, t_0) \in D$. Then the set of points on Γ with $t < t_0$, at which function v is positive, has positive H -measure.*

PROOF. Let Γ_* be the part of set Γ with $t < t_0$. Let us assume that the assertion of the lemma is false: the set γ of points on Γ_* , at which function v is positive, has H -measure zero. Let k be a number: $0 < k < v(P_0)$. Let $w = v - k$, and let G be the set of points of domain D for which $w > 0$.

The closure \overline{G} of domain G can have an intersection with Γ_* only on a set of points of discontinuity of function v , and, therefore, this intersection lies on the line $t = 0$. Indeed, if point $P \in \overline{G} \cap \Gamma_*$ is a point of continuity of function v , then $v(P) \geq k > 0$. Consequently, $v(Q) > 0$ for points Q lying in some neighborhood of point P in \overline{D} , and, therefore, the set of points on Γ_* at which $v > 0$ has positive H -measure, which contradicts our assumption.

Consider now the intersection Δ_τ of set G with line $t = \tau$. We show that there exists a positive number ε such that

$$(4.7) \quad \int_{\Delta_\varepsilon} w(x, \varepsilon) dx < \int_{\Delta_{t_0}} w(x, t_0) dx.$$

Since $w(P_0) > 0$, the right-hand side of (4.7) is then positive, and inequality (4.7) will be proved if we can show that the left-hand side tends towards zero as $\varepsilon \rightarrow 0$. Since $w(x, t)$ is bounded in D , it is then sufficient to show that

$$(4.8) \quad H(\Delta_\varepsilon) \rightarrow 0 \quad \text{as} \quad \varepsilon \rightarrow 0.$$

We show this now. Set γ lies on line $t = 0$ and $H(\gamma) = 0$. We cover γ by disks, the sum of whose diameters is less than δ , where $\delta > 0$ is an arbitrary given number. We show that $\varepsilon > 0$ can be specified so that

$$(4.9) \quad H(\Delta_\varepsilon) < \delta.$$

We denote this covering of set γ by K . We show that for some ε ,

$$(4.10) \quad \Delta_\varepsilon \in K.$$

Let us assume the contrary to be true. Then there exists a sequence of values of ε , converging to zero, and a sequence of points $P_\varepsilon \in \Delta_\varepsilon$, $P_\varepsilon \notin K$. For limit point P_* we have $v(P_*) \geq k$; this point lies on the line $t = 0$, so that $P_* \in \gamma$, which is not possible since P_* is not an interior point of set K . Thus, we have established (4.10), from which (4.9) obviously follows.

Thus we have shown that there exists a number $\varepsilon > 0$ such that inequality (4.7) holds. In what follows, in the course of proving the lemma, we shall assume that $\varepsilon < t_0$ is chosen so that (4.7) is valid.

Let G_ε be the part of domain G included in the strip $\varepsilon < t < t_0$. It is obvious that the closure \overline{G}_ε of domain G_ε belongs to D , and, therefore, function v , together with its derivatives up to the second order with respect to x and up to the first order with respect to t , is continuous in \overline{G}_ε . This is obviously also the case for function w , so that Lw is a continuous function in \overline{G}_ε .

Temporarily, let us make the following assumption:

$$(4.11) \quad b \leq 0, \quad -\frac{\partial a}{\partial x} + b \leq 0,$$

in D .

From the first of these inequalities it follows that

$$Lw \leq 0$$

in G_ε . We write Lw in the form

$$Lw = L_0w + \left(\frac{\partial a}{\partial x} - b\right)w,$$

where

$$(4.12) \quad L_0w = \frac{\partial w}{\partial t} - \frac{\partial}{\partial x} \left(\frac{\partial w}{\partial x} + aw \right).$$

From (4.11) we obtain

$$(4.13) \quad L_0w \leq 0$$

in G_ε . Further, we have

$$(4.14) \quad \iint_{G_\varepsilon} \frac{\partial w}{\partial t} dx dt = \iint_{\Pi_\varepsilon} \chi \frac{\partial w}{\partial t} dx dt = \int_{-\infty}^{\infty} dx \int_{\varepsilon}^{t_0} \chi \frac{\partial w}{\partial t} dt,$$

where Π_ε is the strip $\varepsilon < t < t_0$, and χ is the characteristic function of set G_ε . For each x function $\chi(x, t)$ is either equal to zero or is the characteristic function of a finite or countable number of intervals. Function $w(x, t)$ is different from zero only on those endpoints of intervals which are on the sets Δ_{t_0} and Δ_ε , the latter being sections of domain G_ε by the lines $t = t_0$ and $t = \varepsilon$. Therefore, from (4.14) it follows that

$$\iint_{G_\varepsilon} \frac{\partial w}{\partial t} dx dt = \int_{\Delta_{t_0}} w(x, t_0) dx - \int_{\Delta_\varepsilon} w(x, \varepsilon) dx > 0.$$

Here we have taken inequality (4.7) into account. From this, (4.12), and (4.13), it follows that

$$(4.15) \quad \iint_{G_\varepsilon} \frac{\partial}{\partial x} \left(\frac{\partial w}{\partial x} + aw \right) dx dt > 0.$$

On the other hand, calculation of this integral can be carried out directly:

$$(4.16) \quad \iint_{G_\varepsilon} \frac{\partial}{\partial x} \left(\frac{\partial w}{\partial x} + aw \right) dx dt = \int_{\varepsilon}^{t_0} dt \int_{-\infty}^{\infty} \chi \frac{\partial}{\partial x} \left(\frac{\partial w}{\partial x} + aw \right) dx \leq 0.$$

To prove this inequality we evaluate the inner integral; to this end we consider intervals obtained in sections of domain G_ε by the lines $t = \text{const}$, $\varepsilon < t < t_0$. Let (α, β) be one such interval. Function $w(x, t)$ is nonnegative in this interval

and vanishes at its endpoints. This latter property follows from the fact that the boundary of G_ε has no points in common with Γ . Thus,

$$\int_\alpha^\beta \frac{\partial}{\partial x} \left(\frac{\partial w}{\partial x} + aw \right) dx = \frac{\partial w}{\partial x} \Big|_\beta - \frac{\partial w}{\partial x} \Big|_\alpha \leq 0,$$

since, obviously,

$$\frac{\partial w}{\partial x} \Big|_\beta \leq 0, \quad \frac{\partial w}{\partial x} \Big|_\alpha \geq 0.$$

The contradiction in signs in (4.15) and (4.16) proves the lemma under the assumption (4.11). If inequality (4.11) does not hold, we then make the substitution $z = v \exp(-kt)$. Obviously, z satisfies the inequality

$$\frac{\partial z}{\partial t} - \frac{\partial^2 z}{\partial x^2} - a \frac{\partial z}{\partial x} - (b - k)z \leq 0.$$

It is clear that k can be selected so large that, for the operator just obtained, conditions of the form (4.11) are satisfied. The lemma is therefore true for z . Consequently, it is also true for v . This completes the proof of the lemma. \square

THEOREM 4.6. *If $Lv \geq 0$ in D , and $v \geq 0$ on Γ with the possible exception of a set of H -measure zero, then $v \geq 0$ in D .*

PROOF. First, let us assume that domain D is bounded. Further, let us assume that the theorem is not true: $v(P_0) < 0$ at some point $P_0 \in D$. For function $u = -v$ we conclude, on the basis of the lemma, that the intersection with Γ of the set of points where u is positive has positive H -measure, and this contradicts our hypothesis.

It remains then to consider the case where domain D is unbounded. We change to a new variable:

$$(4.17) \quad w(x, t) = v(x, t) \operatorname{sech} x.$$

Then

$$\operatorname{sech} x \cdot Lv = L_1 w \geq 0 \quad \text{in } D,$$

where

$$\begin{aligned} L_1 w &= \frac{\partial w}{\partial t} - \frac{\partial^2 w}{\partial x^2} - \bar{a} \frac{\partial w}{\partial x} - \bar{b} w, \\ \bar{a}(x, t) &= a(x, t) + 2 \operatorname{th} x, \\ \bar{b}(x, t) &= 1 + a(x, t) \operatorname{th} x + b(x, t). \end{aligned}$$

It is sufficient to prove the theorem for operator L_1 and function w .

We assume at first that

$$(4.18) \quad \bar{b}(x, t) \leq 0$$

in D . We consider the function

$$z = w + \varepsilon, \quad \text{where} \quad \varepsilon > 0.$$

Then $L_1 z = L_1 w - \bar{b}\varepsilon \geq 0$. From (4.17) it follows that

$$|w(x, t)| \leq \sup_{0 \leq t \leq T} |v(x, t)| \operatorname{sech} x \xrightarrow{|x| \rightarrow \infty} 0.$$

Therefore, for $|x| = R$, where R is a sufficiently large number, $z(x, t) > 0$. Consider now the domain $D_R = D \cap \{|x| < R\}$. On the boundary of this domain, function z is positive for $t < T$, with the exception, possibly, of a set of H -measure zero. Therefore, from what has been proved, $z(x, t) \equiv w(x, t) + \varepsilon \geq 0$ in D_R . For each fixed $(x, t) \in D$ we pass to the limit as $\varepsilon \rightarrow 0$. We obtain $w(x, t) \geq 0$.

Thus the theorem has been established under assumption (4.18). The general case may be reduced to the case considered, as was done in the proof of the lemma, by the substitution $z = w \exp(-kt)$ for k sufficiently large. This completes the proof of the theorem. \square

A simple consequence of this theorem is the following uniqueness theorem.

THEOREM 4.7. *If $Lv = 0$ in D and $v = 0$ on Γ , except possibly on a set of H -measure zero, then $v = 0$ in D .*

In our later study of quasilinear equations, the structure of the set of zeros of solutions of the linear equation will play a large role. We present these results for a more particular form of domain D , sufficient for what follows.

Consider functions $x_i(t)$, $i = 1, 2$, given for $t \geq 0$, and which satisfy $x_1(t) < x_2(t)$. We assume that $x_1(t)$ is bounded or that $x_1(t) \equiv -\infty$; function $x_2(t)$ is bounded or $x_2(t) \equiv +\infty$. If functions $x_i(t)$ are bounded, they are assumed to be continuous. By domain D we shall mean the domain included between the curves $x_i(t)$, $i = 1, 2$, and the lines $t = 0$, $t = T$.

The following positiveness theorem for the domain D considered is a direct consequence of Theorems 4.5 and 4.6.

THEOREM 4.8. *If $Lv \geq 0$ in D and $v \geq 0$ on Γ , except, possibly, for a set of H -measure zero, then $v \geq 0$ in D . If, moreover, $v > 0$ at some point of continuity $(x_1, t_1) \in \Gamma$, then $v > 0$ in $D + \Gamma_T$ for $t_1 \leq t \leq T$.*

We turn now to the question concerning the structure of the set of zeros of a solution of the equation $Lv = 0$. We show, under specified conditions, that this is a connected set in the sections $\Delta(t)$ of domain D . This will follow from Theorems 4.9 and 4.10, presented below and clarified in greater detail. At first, we introduce classes A and A_0 of functions, given on curve S , homeomorphic to the interval $(0, 1)$. This homeomorphism determines the ordering of points on S : $P_1 < P_2$ if for corresponding points p_1 and p_2 of the interval $(0, 1)$ we have the inequality $p_1 \leq p_2$.

DEFINITION 4.1. Function f , given on S , belongs to class A if, for an arbitrary point $P_0 \in S$ such that $f(P_0) > 0$, the inequality $f(P) > 0$ is satisfied for all $P \in S$;

$P > P_0$, and, for an arbitrary point $P_0 \in S$ such that $f(P_0) < 0$, the inequality $f(P) < 0$ is satisfied for all $P \in S$; $P < P_0$.

DEFINITION 4.2. Function f , given on S , belongs to class A_0 if, for an arbitrary point $P_0 \in S$ such that $f(P_0) > 0$, the inequality $f(P) \geq 0$ is satisfied for all $P \in S$; $P > P_0$, and for an arbitrary point $P_0 \in S$ such that $f(P_0) < 0$, the inequality $f(P) \leq 0$ is satisfied for all $P \in S$; $P < P_0$.

Thus, class A_0 differs from class A only by the fact that nonstrict inequalities are involved. In the definition given above, orientation of S is essential. We indicate now how curves encountered in the sequel are oriented. Recall that Γ is a part of the boundary of domain D for $t < T$. Obviously, in the case considered, Γ is homeomorphic to the interval $(0, 1)$. We shall assume curve Γ is oriented so that, as one moves along Γ from point P_1 to point P_2 , $P_1 < P_2$, domain D stays to the left.

We consider sections $\Delta(t_0)$ of domain D by line $t = t_0$ for $0 < t_0 < T$. Obviously, $\Delta(t_0)$ is homeomorphic to the interval $(0, 1)$. We shall assume that $(x_1, t_0) < (x_2, t_0)$ if $x_1 \leq x_2$.

THEOREM 4.9. Let v be a solution of equation $Lv = 0$. If $v \in A_0$ on Γ , then $v \in A$ in section $\Delta(t_0)$ of domain D for $0 < t_0 < T$.

PROOF. Let $v(x_0, t_0) > 0$ at some point $P_0 = (x_0, t_0) \in D$. We denote by $S_+(P_0)$ the set of all points $Q \in D$ which can be joined to point P_0 by a broken line along which coordinate t does not decrease from Q to P_0 and $v(x, t) > 0$. We denote by Λ the set of such broken lines, and we let Γ_+ be the part of the boundary of the set $S_+(P_0)$ lying in the half-plane $t < t_0$.

We show that if $Q \in D \cap \Gamma_+$, then $v(Q) = 0$. Let us suppose that this is not so, i.e., that there exists a point $P_1 \in D \cap \Gamma_+$ such that $v(P_1) > 0$. Consider the rectangle

$$\Pi = \{(x, t): x_1 - \varepsilon < x < x_1 + \varepsilon, \quad t_1 - \varepsilon < t < t_1 + \varepsilon\},$$

where ε is so small that $\Pi \subset D$ and, in it, $v > 0$. Let $P_2 = (x_2, t_2)$ be an arbitrary point, belonging simultaneously to the sets Π and $S_+(P_0)$, and let l be a broken line from Λ , joining P_2 and P_0 . Further, let $P_3 = (x_2, t_1 + \varepsilon)$, and let P_2P_3 be a segment joining points P_2 and P_3 . Applying Theorems 4.5 and 4.6 to the domain bounded by the segment P_2P_3 , the line $t = t_1 + \varepsilon$, and the part of the broken line l with $t < t_1 + \varepsilon$, we find that $P_3 \in S_+(P_0)$ and, consequently, that $\Pi \subset S_+(P_0)$, which leads to a contradiction. Thus we have shown that the function v vanishes on the set $D \cap \Gamma_+$.

Function v , by virtue of Theorem 4.7, is positive on a set of positive measure on Γ_+ . All points of this set, according to what has been proved, must belong to Γ . Thus there exists a set M of positive H -measure, belonging to $\Gamma_+ \cap \Gamma$, on which function v is positive. Since the set of points of discontinuity of function v has H -measure zero, we can then select a point $P_* = (x_*, t_*) \in M$, which is a point of continuity of v and coincides with neither $x_i(0)$ nor $x_i(t_0)$, $i = 1, 2$.

We show that point P_0 can be joined to boundary Γ by a broken line l_* belonging to domain D , except for one end of it, on which coordinate t does not decrease when moving towards point P and on which $v > 0$. With this in mind, we select a neighborhood Ω of point P_* in D so small that $v > 0$ and $t < t_0$ in this neighborhood. Since $P_* \in \Gamma_+$, there exist a point $P_1 \in S_+(P_0) \cap \Omega$ and a broken line $l_1 \in \Lambda$, joining

P_1 with P_0 . We connect P_1 with a point $P^* \in \Gamma$ by a segment lying in Ω , except for its endpoint. As such a segment, we take P_1P_* , if $t_* = 0$, or a segment parallel to the x -axis, if $t_* > 0$. We obtain the desired broken line l_* .

Without loss of generality, we can assume that the broken line we have constructed intersects line $t = t_0$ at only one point, since, otherwise, the single point of intersection could be attained by a small rotation of the link of the broken line lying on the line $t = t_0$.

We now consider domain G bounded by broken line l_* , a part of curve Γ for $t \leq t_0$, consisting of points $P > P^*$, and the part of the line $t = t_0$ for $x_0 \leq x < x_2(t_0)$. Since by a condition of the theorem $v \in A_0$ on Γ and $v > 0$ at point P^* , it follows that $v \geq 0$ for $P > P^*$ on Γ . Applying Theorems 4.5 and 4.6 to domain G , we find that $v > 0$ on line $t = t_0$ for $x_0 \leq x < x_2(t_0)$.

In exactly the same way we show that if $v(P_0) < 0$, then $v < 0$ for $t = t_0$, $x_1(t) < x \leq x_0$. Consequently, $v \in A$ on $\Delta(t_0)$. This completes the proof of the theorem. \square

We present yet another theorem of this kind. Here we impose an additional restriction on function $v(x, t)$ if $x_1(t)$ or $x_2(t)$ is finite. Recall that function $v(x, t)$, together with the derivatives entering into operator L , are assumed to be continuous in domain $D + \Gamma_T$. Considering the function $v(x, t)$ in the closure \overline{D} of domain D , we assume the following conditions to be satisfied: 1) function $v(x, t)$ is continuous in \overline{D} , except, possibly, for a set of points of H -measure zero belonging to an open interval lying in the intersection of \overline{D} with the x -axis; 2) if $x_i(t)$, $i = 1, 2$, is finite, then the derivative $v'(x, t)$ exists and is continuous (with respect to \overline{D}) at each point of the curve $x = x_i(t)$, $0 \leq t \leq T$, on which $v(x, t) = 0$.

REMARK. In applications to nonlinear equations the requirement for existence of the derivative $v'(x, t)$ only at points at which $v(x, t) = 0$ on curves $x = x_i(t)$ makes it possible to consider piecewise-continuous initial functions in the Cauchy problem and does not require existence of the derivative (see Theorem 5.4).

THEOREM 4.10. *Let v be a solution of the equation $Lv = 0$ in domain D , satisfying the following condition: if $x_i(t)$, $i = 1, 2$, is finite and $v(x_i(t), t) = 0$, then $v'(x_i(t), t) > 0$ ($0 \leq t \leq T$). Then if $v \in A_0$ on $\Delta(0)$, then $v \in A$ on $\Delta(t)$ for $0 < t < T$.*

PROOF. The case $x_1(t) \equiv -\infty$, $x_2(t) \equiv +\infty$ was considered in the preceding theorem.

We begin with the case in which both functions $x_1(t)$ and $x_2(t)$ are finite. We assume that for some $t \in (0, T)$ the function v does not belong to class A on $\Delta(t)$. We denote by t_0 the infimum of all t for which v does not belong to class A on $\Delta(t)$. Let us assume at first that $t_0 > 0$. Let $P_1 = (x_1(t_0), t_0)$, $P_2 = (x_2(t_0), t_0)$ (see Figure 4.1).

We construct neighborhoods Ω_1 and Ω_2 of points P_1 and P_2 in D , such that in each of these neighborhoods either function v is different from zero or $v' > 0$. By a condition of the theorem this is possible. Consider, next, the rectangle $\Pi = Q_1Q_2S_2S_1$:

$$(4.19) \quad x_1(t_0) + \varepsilon_1 \leq x \leq x_2(t_0) - \varepsilon_1, \quad t_0 - \varepsilon_2 \leq t \leq t_0 + \varepsilon_2.$$

Numbers $\varepsilon_1 > 0$ and $\varepsilon_2 > 0$ are chosen so small that the following conditions are satisfied:

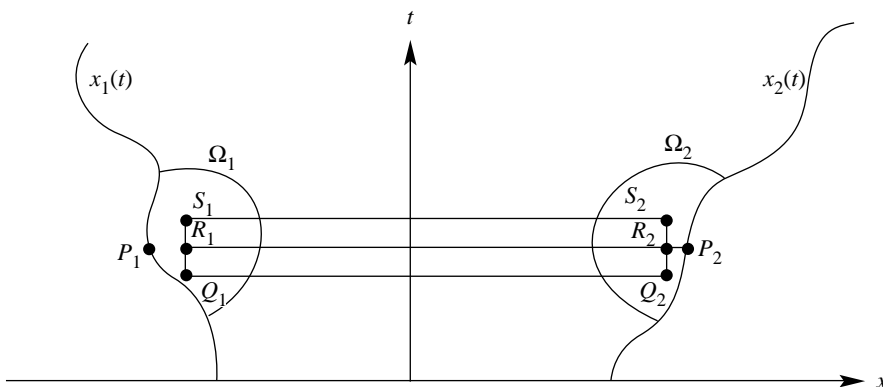

FIGURE 4.1

- 1) $\Pi \subset D$;
- 2) $Q_1, S_1 \in \Omega_1, Q_2, S_2 \in \Omega_2$;
- 3) Function v does not vanish on the intervals $[Q_1, S_1]$ and $[Q_2, S_2]$ and on the half-intervals $(P_1, R_1]$ and $[R_2, P_2)$.

We show that such a choice is possible. Actually, if $v \neq 0$ in a neighborhood being considered, this is obvious. But if, for example, $v(P_1) = 0$, then, by a condition of the theorem, $v' > 0$ at this point. Therefore, for ε_1 sufficiently small, the function is positive on the half-interval $(P_1, R_1]$, and, for ε_2 sufficiently small, it is positive on $[Q_1, S_1]$. Similarly for point P_2 , except that the function there is negative.

According to the definition of number t_0 , function v belongs to class A on $\Delta(t_0 - \varepsilon_2)$. Taking into account the fact that v does not vanish on the intervals $[Q_1, S_1]$ and $[Q_2, S_2]$, we find that $v \in A$ on the broken line $S_1Q_1Q_2S_2$. Applying Theorem 4.9 to the rectangle Π , we find that $v \in A$ in a section of this rectangle by a line $t = \tau$ for $t_0 - \varepsilon_2 < \tau < t_0 + \varepsilon_2$.

According to the definition of number t_0 , we can find a number $t_1, t_0 \leq t_1 < t_0 + \varepsilon_2$, such that $v \notin A$ on $\Delta(t_1)$. But since $v \in A$ in a section of rectangle Π by line $t = t_1$, then, outside of this rectangle, at some point $(x_1, t_1), x_1(t_1) < x_1 < x_2(t_1)$, we have $v(x_1, t_1) = 0, v'(x_1, t_1) \leq 0$. We obtain a contradiction, since point (x_1, t_1) cannot, by their construction, belong to neighborhoods Ω_1 and Ω_2 .

We have thus proved the theorem in the case of $x_i(t)$ finite and $t_0 > 0$. We consider now the case $t_0 = 0$. In this case we consider the rectangle $R_1R_2S_2S_1$. Numbers ε_1 and ε_2 are chosen in a manner similar to the preceding. Since, by definition, $v \in A_0$ on $\Delta(0)$, it is then easy to see that $v \in A_0$ on the broken line $S_1R_1R_2S_2$. Therefore, applying Theorem 4.9 to the rectangle under consideration, we find that $v \in A$ in its sections. This, as before, leads to a contradiction.

To complete the proof of the theorem we need only consider the case in which one of the functions $x_i(t)$ becomes infinite. In this case the proof is exactly the same, except that here, instead of rectangles, we consider half-strips. For example, if $x_2(t) = \infty$, then, instead of rectangle (4.19), we take the half-strip

$$x_1(t_0) + \varepsilon_1 \leq x, \quad t_0 - \varepsilon_2 \leq t \leq t_0 + \varepsilon_2.$$

The theorem is proved. □

Theorems 4.9 and 4.10 enable us to draw a conclusion concerning connectivity of the set of zeros of solutions of the equation $Lv = 0$. Indeed, if function v belongs to class A , then, obviously, the set of its zeros is connected (not excluding here the empty set of zeros). Therefore, when the conditions for Theorem 4.9 or 4.10 are satisfied, we can conclude that the set of zeros of solutions of equation $Lv = 0$ is connected in sections $\Delta(t)$ of domain D .

4.3. Comparison theorems for quasilinear equations. As a consequence of the theorems on positiveness of solutions of linear equations, presented in the preceding section, we obtain comparison theorems for solutions of the Cauchy problem (4.1), (4.2) [Kolm 1].

Let us assume that functions $F(x, t, v)$ and $f(x)$ satisfy the conditions of §4.1, and, in addition, for simplicity, that $F(x, t, v)$ has continuous and bounded derivatives for $-\infty < x < +\infty$, $t \geq 0$, and v bounded. Then, for $t > 0$ and for all x :

1. If $\tilde{F}(x, t, v)$ satisfies the same conditions as $F(x, t, v)$, if $\tilde{v}(x, t)$ is a solution of the corresponding Cauchy problem, and if $\tilde{F}(x, t, v) \geq F(x, t, v)$, then $\tilde{v}(x, t) \geq v(x, t)$.
2. If $f_1(x) \geq f_2(x)$ and $v_i(x, t)$, $i = 1, 2$, are solutions with the initial conditions $v_i(x, 0) = f_i(x)$, then $v_1(x, t) \geq v_2(x, t)$.
3. If $f(x) \geq 0$ and $F(x, t, 0) = 0$, then $v(x, t) \geq 0$. If $f(x) \leq 1$ and $F(x, t, 1) = 0$, then $v(x, t) \leq 1$.
4. If $f(x) \geq 0$, $f(x) \neq 0$, and $F(x, t, 0) = 0$, then $v(x, t) > 0$.

All these properties are obviously satisfied for solutions of the Cauchy problem (4.3), (4.4). (Here and later we assume that $F(u)$ is a continuously differentiable function.) For this case we present two more simple propositions.

5. If $f(x)$ is a nonincreasing function, not identically equal to a constant, then $u(x, t)$ decreases monotonically with respect to x for each $t > 0$.

This follows from Theorem 4.8, applied to the difference $u(x + h, t) - u(x, t)$, where for h we can take an arbitrary constant.

6. If $f(x)$ is a twice continuously differentiable function and

$$f'' + F(f) \leq 0,$$

then $u(x, t)$ is nonincreasing with respect to t for each fixed x .

This follows from Theorem 4.8, applied to $\partial u / \partial t$. We refer to $f(x)$ in this case as an upper function. We define a lower function similarly.

If as upper (lower) functions we have $f_1(x)$ and $f_2(x)$, then the solution $u(x, t)$ of the Cauchy problem (4.3), (4.4) is nonincreasing (nondecreasing) for $f(x) \equiv \min(f_1(x), f_2(x))$ ($f(x) \equiv \max(f_1(x), f_2(x))$).

All these propositions carry over in an obvious way to the Cauchy problem

$$(4.20) \quad \frac{\partial u}{\partial t} = \frac{\partial^2 u}{\partial x^2} + c \frac{\partial u}{\partial x} + F(u),$$

$$(4.21) \quad u(x, 0) = f(x),$$

where c is a constant.

We note also that for problems (4.3), (4.4) and (4.20), (4.21), if $F(0) = F(1) = 0$ and $0 \leq f(x) \leq 1$, then from estimates of the solution $0 \leq u(x, t) \leq 1$ there follow estimates of the derivatives $u'(x, t)$, $u''(x, t)$, and $\dot{u}(x, t)$, independent of x , t (for $t \geq t_0 > 0$) and the initial condition $f(x)$ (see Chapter 5, §5).

We now turn our attention to the less traditional comparison theorems for quasilinear equations. (These are sometimes referred to as comparison theorems on the phase plane.) These theorems are conveniently formulated for functions $p(u, t)$, which associate to a solution $u(x, t)$ its derivative $u'(x, t)$. We give a precise definition of function $p(u, t)$.

We consider the Cauchy problem (4.3), (4.4), and we assume that the initial condition $f(x)$ is a bounded piecewise-continuous, piecewise-smooth function with a finite number of points of discontinuity for the function and its derivative, for which, at each point, the following limits exist:

$$\lim_{x \searrow x_0} f(x), \quad \lim_{x \nearrow x_0} f(x), \quad \lim_{x \searrow x_0} f'(x), \quad \lim_{x \nearrow x_0} f'(x).$$

Moreover let us assume that $f(x)$ is a monotonically nonincreasing function, not identically equal to a constant. Then for each $t > 0$, $u(x, t)$ is a monotonically decreasing bounded function, continuous along with its derivative $u'(x, t)$. For arbitrary u , $u(+\infty, t) < u < u(-\infty, t)$, we set $p(u, t) = u'(x, t)$, where x is such that $u(x, t) = u$.

We introduce some notation. If it is required to indicate the dependence on the initial condition, we shall write $u(x, t; f)$ and $p(u, t; f)$. We write $u_{\pm}(t)$ or $u_{\pm}(t, f)$ to denote the function $u(\pm\infty, t; f)$, so that, in particular, $u_{\pm}(0; f) = f(\pm\infty)$. In certain cases it is convenient also to use the notation $f_h(x) = f(x + h)$ and $f_{ih}(x) = f_i(x + h)$.

THEOREM 4.11. *Let functions $f_1(x)$ and $f_2(x)$ satisfy the conditions given above (in the definition of $p(u, t)$) and*

$$(4.22) \quad 0 \leq f_2(+\infty) \leq f_1(+\infty), \quad f_1(-\infty) \leq f_2(-\infty) \leq 1.$$

If $f_1(x + h) - f_2(x) \in A_0$ (see §4.2) for arbitrary h , then for $t > 0$

$$(4.23) \quad p(u, t; f_2) \leq p(u, t; f_1), \quad u_+(t; f_1) < u < u_-(t; f_1).$$

PROOF. Since functions $u_{\pm}(t; f_i)$, $i = 1, 2$, satisfy equation $du/dt = F(u)$ (see Theorem 4.2), it then follows from inequalities (4.22) that in the interval $I = (u_+(t; f_1); u_-(t; f_1))$ the function $p(u, t; f_2)$ is defined.

For arbitrary preassigned $t > 0$ and $u \in I$ we can select h so that

$$u(x, t; f_{1h}) = u(x, t; f_2) = u.$$

Function

$$v(x, t) = u(x, t; f_{1h}) - u(x, t; f_2)$$

satisfies the linear equation (4.5), where $a = 0$, coefficient b can be easily found, and $v(x, 0) \in A_0$. By virtue of Theorem 4.9, $v(x, t) \in A(t)$ for $t > 0$, whence inequality (4.23) follows. This completes the proof of the theorem. \square

Before discussing the implications of this theorem, we define function $p(u, t)$ for $t = 0$, limiting ourselves, for simplicity, to strictly monotonic continuous initial conditions. Let $f(+\infty) < u < f(-\infty)$, and let x_0 be a solution of equation $f(x) = u$. If the derivative $f'(x)$ is continuous at point x_0 , we then set, as before, $p(u, 0) = f'(x_0)$. But if the derivative undergoes a discontinuity at this point, we

shall then consider function p to be many-valued at this value of u and to take on all values between $\lim_{x \nearrow x_0} f'(x)$ and $\lim_{x \searrow x_0} f'(x)$.

COROLLARY 1. *Let the inequalities (4.22) be satisfied. If*

$$(4.24) \quad p(u, 0; f_2) < p(u, 0; f_1), \quad u_+(0; f_1) < u < u_-(0; f_1),$$

then inequality (4.23) holds for all $t > 0$.

REMARK. At points where the functions $p(u, 0; f_i)$ are many-valued, inequality (4.24) is to be understood in the sense that all values of function $p(u, 0; f_1)$ are larger than all values of function $p(u, 0; f_2)$, although this condition can be weakened for those u for which both functions are many-valued.

PROOF. It is sufficient to show that $f_1(x+h) - f_2(x) \in A_0$ for arbitrary h . We show, for example, that inequality $f_1(x_0+h) > f_2(x_0)$ implies the inequality

$$f_1(x+h) \geq f_2(x) \quad \text{for } x > x_0.$$

Let us suppose that this is not so, and that for some $x_1 > x_0$, $f_1(x_1+h) < f_2(x_1)$. Then an x_2 can be found, $x_0 < x_2 < x_1$, such that $f_1(x_2+h) = f_2(x_2)$ and

$$\lim_{x \nearrow x_2} f'_1(x+h) \leq \lim_{x \nearrow x_2} f'_1(x),$$

which contradicts inequality (4.24). This establishes the corollary. \square

We remark that propositions of this type can be formulated also for non-strictly monotone piecewise-continuous initial conditions (if equation $f(x) = u$ has no solutions for $f(+\infty) < u < f(-\infty)$, we then set $p(u, 0) = -\infty$) and also for nonmonotone initial conditions.

COROLLARY 2. *Let $\chi(x) = 1$ for $x \leq 0$ and $\chi(x) = 0$ for $x > 0$. Then for each u , $0 < u < 1$, function $p(u, t; \chi)$ is monotonically nondecreasing with respect to t .*

PROOF. By virtue of the theorem for an arbitrary smooth monotonically decreasing function $f(x)$, $0 \leq f(x) \leq 1$, we have the following inequality for $t > 0$:

$$p(u, t; \chi) \leq p(u, t; f), \quad u_+(t; f) < u < u_-(t; f).$$

Setting $f(x) = u(x, t_0; \chi)$ for arbitrary t_0 , we obtain

$$p(u, t; \chi) \leq p(u, t + t_0; \chi), \quad 0 < u < 1.$$

The corollary is thereby established. \square

The last proposition turns out to be essential in establishing the approach of solutions to a wave. Behavior of this kind for a solution with initial function $\chi(x)$ was observed in [Kolm 1] and is an important result of this paper.

Up to this point we have been concerned with solutions of the Cauchy problem (4.3), (4.4). It is obvious that all the propositions presented remain valid for the Cauchy problem (4.20), (4.21). We now present one of the versions of comparison theorems on the phase plane for the boundary value problem

$$(4.25) \quad \frac{\partial u}{\partial t} = \frac{\partial^2 u}{\partial x^2} + F(u), \quad u(x, 0) = f_1(x),$$

$$(4.26) \quad u(x_i(t), t) = \varphi_i(t), \quad i = 1, 2,$$

in domain D , consisting of points (x, t) for which $x_1(t) < x < x_2(t)$, $0 < t < T$.

Function $x_1(t)$, as in §4.2, is continuous and bounded, or $x_1(t) \equiv -\infty$; function $x_2(t)$ is continuous and bounded, or $x_2(t) \equiv \infty$.

THEOREM 4.12. *Let solution $u(x, t; f_1)$ of problem (4.25), (4.26), along with its derivative $u'(x, t; f_1)$, be continuous in \overline{D} , and assume also that it decreases monotonically with respect to x for each t , $0 \leq t \leq T$. Further, let $u(x, t; f)$ be a solution of the Cauchy problem (4.3), (4.4), and assume also that it and its derivative $u'(x, t; f)$ are continuous and that $u(x, t; f)$ decreases monotonically with respect to x for $0 \leq t \leq T$.*

If the following conditions are satisfied,

$$(4.27) \quad u_+(t; f) < \varphi_2(t), \quad \varphi_1(t) < u_-(t; f), \quad t \geq 0,$$

$$(4.28) \quad p(u, 0; f) < p(u, 0; f_1), \quad \varphi_2(0) \leq u \leq \varphi_1(0),$$

$$(4.29) \quad p(\varphi_i(t), t; f) < p(\varphi_i(t), t; f_1), \quad t \geq 0, \quad i = 1, 2,$$

then, for $t \geq 0$,

$$(4.30) \quad p(u, t; f) \leq p(u, t; f_1), \quad \varphi_2(t) \leq u \leq \varphi_1(t).$$

PROOF. It is easy to see that function

$$v(x, t) = u(x, t; f_1) - u(x, t; f_h)$$

satisfies the conditions of Theorem 4.10 in domain D for arbitrary h . The rest of the proof is carried out as was done in the preceding theorem. This completes the proof of the theorem. \square

We remark that this theorem can be stated, omitting certain details, in a form traditional for parabolic equations: If inequality (4.30) is satisfied for $t < T$ on the boundary of domain D^* of the (u, t) -plane, the latter being defined by $\varphi_2(t) < u < \varphi_1(t)$, $0 < t < T$, then it is also satisfied throughout the interior of the domain. The theorem remains valid if the inequalities (4.28)–(4.30) are reversed. It also admits various generalizations, which we shall not discuss here.

§5. Approach to waves and systems of waves

5.1. Concept concerning approach to a wave and a system of waves.

Let $w(x)$ be a wave propagating with speed c , i.e., a monotonically decreasing, twice continuously differentiable function, satisfying the equation

$$(5.1) \quad w'' + cw' + F(w) = 0$$

and conditions at infinity:

$$w(-\infty) = w_-, \quad w(+\infty) = w_+, \quad w_- > w_+.$$

(As has already been mentioned, nonmonotone waves can also be considered. We

shall show that they are unstable and, in this sense, hold no special interest.) If $u(x, t)$ is a solution of the Cauchy problem

$$(5.2) \quad \frac{\partial u}{\partial t} = \frac{\partial^2 u}{\partial x^2} + F(u),$$

$$(5.3) \quad u(x, 0) = f(x),$$

then $u(x + ct, t)$ obviously satisfies the equation

$$\frac{\partial u}{\partial t} = \frac{\partial^2 u}{\partial x^2} + c \frac{\partial u}{\partial x} + F(u),$$

and the function $w(x)$ is a stationary solution of this equation.

DEFINITION 5.1. We shall say that solution $u(x, t)$ of problem (5.2), (5.3) approaches a wave uniformly if as $t \rightarrow \infty$ we have, uniformly with respect to $x \in (-\infty, \infty)$, the convergence

$$(5.4) \quad u(x + ct, t) \rightarrow w(x - h),$$

where h is some number.

We note that the wave $w(x)$ is invariant relative to a translation in x . The number h , appearing in (5.4), depends on the initial conditions (5.3). On the other hand, it is clear that, making a translation in x in the initial condition, we obtain the result that the solution $u(x, t)$, as well as its limit with respect to t , is translated by this amount. Therefore, with no loss of generality, we can fix the wave, assigning to it its value at zero:

$$(5.5) \quad w(0) = w_0,$$

where w_0 is an arbitrary number between w_+ and w_- , assumed to be given.

It turns out to be the case, which we shall show in what follows, that in studying the convergence of solutions of the Cauchy problem to a wave it is not sufficient to consider only the uniform approach to a wave. Presently, we shall indicate other forms of convergence important in the study of waves.

DEFINITION 5.2. We say that solution $u(x, t)$ of problem (5.2), (5.3) approaches a wave in form if, for all sufficiently large t , there exists a unique solution of the equation

$$(5.6) \quad u(x, t) = w_0$$

(which we denote by $x = m(t)$) and if we have the following convergence, uniformly with respect to x :

$$(5.7) \quad u(x + m(t), t) \rightarrow w(x) \quad \text{as } t \rightarrow \infty.$$

Solution $u(x, t)$ of problem (5.2), (5.3) approaches a wave in speed if

$$(5.8) \quad m'(t) \rightarrow c \quad \text{as } t \rightarrow \infty.$$

The descriptive interpretation of these definitions is obvious. In defining the approach in form we displace all curves, representing solutions of problem (5.2), (5.3), in the (x, u) -plane in such a way that for all t they pass through point $(0, w_0)$, and such curves converge uniformly to a wave. The meaning of convergence in speed is

that the speed of the point at which solution $u(x, t)$ of the nonstationary equation has a given value tends towards the speed of the wave.

The following proposition shows how these kinds of convergence are interrelated.

PROPOSITION 5.1. 1) *Uniform approach of solution $u(x, t)$ of problem (5.2), (5.3) to a wave implies an approach in form and the convergence*

$$(5.9) \quad m(t) - ct \rightarrow h \quad \text{as} \quad t \rightarrow \infty.$$

2) *Approach to a wave in form implies an approach in speed.*

3) *Approach to a wave in form and the convergence (5.9) implies uniform approach to a wave.*

PROOF. Let

$$(5.10) \quad v(x, t) = u(x + ct + h, t).$$

From (5.4) it follows that

$$(5.11) \quad v(x, t) \rightarrow w(x) \quad \text{as} \quad t \rightarrow \infty$$

uniformly with respect to x . Let δ be an arbitrary small positive number. From (5.5) and monotonicity of the wave, it follows that

$$w(-\delta) > w_0, \quad w(\delta) < w_0.$$

By virtue of (5.11) we have

$$v(-\delta, t) > w_0, \quad v(\delta, t) < w_0$$

for all sufficiently large t . This implies existence of a solution $x = \mu(t)$ of the equation

$$(5.12) \quad v(x, t) = w_0,$$

satisfying the condition

$$|\mu(t)| < \delta.$$

In view of the arbitrariness of δ , we have

$$(5.13) \quad \mu(t) \rightarrow 0 \quad \text{as} \quad t \rightarrow \infty.$$

From (5.10) we now see that

$$x = m(t) \equiv \mu(t) + ct + h$$

is a solution of equation (5.6), and we conclude from (5.13) that (5.9) is valid.

To prove uniqueness of a solution of equation (5.12), we note, in view of the monotonicity of wave w , that

$$|w(x) - w_0| \geq \rho > 0$$

outside of interval $|x| < 1$. Therefore, by virtue of (5.11), there can be no solution of equation (5.12) outside of this interval for sufficiently large t . Further, since the derivative $u''(x, t)$ is uniformly bounded (see Chapter 5, §5), the convergence (5.11) then implies the convergence $v'(x, t) \rightarrow w'(x)$ as $t \rightarrow \infty$ and $|x| < 1$. In addition, $w'(x) < 0$ (see §3.1). Therefore, $v'(x, t) < 0$ for $|x| < 1$ and sufficiently large t . Thus $v(x, t)$ is monotone in x for $|x| < 1$, and, consequently, the solution of equation (5.12) is unique.

To complete the proof of the first item of Proposition 5.1, it remains merely to verify that (5.7) holds, i.e.,

$$(5.14) \quad v(x + \mu(t), t) \rightarrow w(x),$$

uniformly with respect to x . This follows from the fact that $v(x + \mu(t), t) - w(x + \mu(t)) \rightarrow 0$, uniformly with respect to x , as $t \rightarrow \infty$, by virtue of (5.11); and $w(x + \mu(t)) - w(x) \rightarrow 0$, uniformly with respect to x , as $t \rightarrow \infty$, by virtue of (5.13).

We turn now to a proof of the second item of Proposition 5.1. Differentiating equation $u(m(t), t) = w_0$ with respect to t , we obtain

$$(5.15) \quad m'(t) = -\frac{u''(m(t), t) + F(u(m(t), t))}{u'(m(t), t)}.$$

Since the convergence (5.7) and the uniform boundedness of the derivatives u'' and u''' (see Chapter 5, §5) imply convergence of the derivatives

$$u'(m(t), t) \rightarrow w'(0), \quad u''(m(t), t) \rightarrow u''(0),$$

the relation (5.8) then follows by virtue of (5.15).

We turn now to the last item of Proposition 5.1. Let $\mu(t) = m(t) - ct - h$. Then from (5.9) we obtain (5.13). For function $v(x, t)$, defined by equation (5.10), we have (5.14), by virtue of (5.7). Convergence (5.11) then follows from this and from (5.13). The proposition is thereby proved. \square

We consider two basic kinds of convergence to a wave: uniform convergence and convergence in form and speed. As shown in [Kolm 1], for the source $F(u)$ and the initial condition, considered therein, we have convergence to a wave in form and speed, but not uniform convergence. On the other hand, in later papers (references are supplied in the commentary to §6) it was shown that for some other kinds of sources and initial conditions, we do have uniform approach to a wave.

It is clear from the proposition just proved that the difference between convergence in form and uniform convergence may be reduced to the behavior of function $m(t)$ as $t \rightarrow \infty$; more precisely, its relationship with ct . We turn our attention now to the fact that $m(t)$ and ct describe the dependence on time of the displacement of a point with a given value for a solution of the Cauchy problem and for a wave, respectively. In the case of uniform convergence $m(t) - ct$ tends towards a constant, while in the case of convergence in form we can only assert that the derivative of this difference tends towards zero. For the source considered in [Kolm 1], the asymptotics of $m(t)$ were found in later studies (see [McK 1, Uch 2]):

$$m(t) = h + ct + k \ln t + \dots,$$

where k is a constant, from which the indicated difference is seen explicitly.

We make yet another remark concerning the relationship between $m(t)$ and c . Function $m'(t)$ describes the speed of the displacement of point x , determined from equation (5.6). For this speed we have equation (5.15). For the wave speed we obtained the minimax representation (see §3.3, Theorem 3.14) in which the expression used is, in fact, of the same form as the right-hand side of (5.15). According to this representation, if $u(x, t)$ is monotone in x , then the maximum of the right-hand side of (5.15), taken over all $w_0 \in (w_+, w_-)$ with respect to which $m(t)$ is determined from (5.6), gives an upper estimate of the speed, while the

minimum gives a lower estimate of the speed. (It is necessary here to specify the class of initial conditions. For example, in case the wave is unique, $f(x)$ can be an arbitrary monotone piecewise-continuous function with corresponding values at infinity.) Thus, at each instant of time, the wave speed is confined between the smallest and the largest speeds for the motion of points on a solution profile of the Cauchy problem.

In studying convergence of solutions of the Cauchy problem to a wave, comparison theorems on the phase plane introduced in §4.3 are useful. We consider the case of monotone solutions $u(x, t)$. Remarks concerning nonmonotone solutions appear in the commentaries in §6. As in the formulation of comparison theorems, we make use of function $p(u, t)$, which puts the value of the derivative $u'(x, t)$ into correspondence with the value of u , where x is determined from the relationship $u(x, t) = u$. We denote by $p_0(u)$ the corresponding function for a wave. As we did earlier, we set $u_{\pm}(t) = \lim u(x, t)$ as $x \rightarrow \pm\infty$.

We define yet another kind of approach to a wave.

DEFINITION 5.3. We say that a solution $u(x, t)$ of problem (5.2), (5.3) approaches a wave in the phase plane if the convergence

$$(5.16) \quad p(u, t) \rightarrow p_0(u) \quad \text{as} \quad t \rightarrow \infty$$

holds for $u \in (w_+, w_-)$, uniform on each closed subset of the interval (w_+, w_-) , and

$$(5.17) \quad u_{\pm}(t) \rightarrow w_{\pm} \quad \text{as} \quad t \rightarrow \infty.$$

We shall show below that convergence to a wave in form is equivalent to convergence on the phase plane. Before giving this proof, we prove an auxiliary lemma.

LEMMA 5.1. *Let function $v_0(x)$ be twice continuously differentiable on the interval $[x_1, x_2]$, and let function $v(x, t)$ have a continuous second derivative with respect to x , uniformly bounded with respect to t . We assume that $v'_0(x) < 0$, $v'(x, t) < 0$ for $x \in [x_1, x_2]$ and all t , and $v(x_0, t) = v_0(x_0) = v_*$ for some $x_0 \in [x_1, x_2]$ and v_* .*

Then in order for the convergence

$$(5.18) \quad v(x, t) \rightarrow v_0(x), \quad t \rightarrow \infty,$$

to occur uniformly on an arbitrary interval $[y_1, y_2]$ embedded in the interval (x_1, x_2) , it is necessary and sufficient that for t sufficiently large the function $p(u, t)$ be defined on an arbitrary interval $[u_1, u_2]$ embedded in the interval $(v_0(x_2), v_0(x_1))$, and

$$(5.19) \quad p(u, t) \rightarrow p_0(u) \quad \text{as} \quad t \rightarrow \infty,$$

uniformly on an arbitrary such interval.

REMARK. In the lemma it is not assumed that $v(x, t)$ is a solution of problem (5.2), (5.3) and that $v(x)$ is a wave. Functions $p(u, t)$ and $p_0(u)$ are defined as before:

$$\begin{aligned} p(u, t) &= v'(x, t), & \text{where} & \quad u = v(x, t), \\ p_0(u) &= v'_0(x), & \text{where} & \quad u = v_0(x). \end{aligned}$$

PROOF. Assume that the convergence (5.18) holds. We take an arbitrary interval $[u_1, u_2]$, as described in the statement of the lemma. For t sufficiently large,

function $p(u, t)$ is defined on this interval. By virtue of the uniform boundedness of second derivatives, we have the convergence

$$(5.20) \quad v'(x, t) \rightarrow v'_0(x) \quad \text{as} \quad t \rightarrow \infty,$$

uniform on an arbitrary interval $[y_1, y_2]$, embedded in the interval (x_1, x_2) .

Let $u_0 \in [u_1, u_2]$. We show that $p_0(u_0, t) \rightarrow p_0(u_0)$. For this purpose we denote by ξ_0 and $\xi(t)$ solutions of the equations

$$v_0(x) = u_0 \quad \text{and} \quad v(x, t) = u_0,$$

respectively. It is clear that $\xi(t) \rightarrow \xi_0$. From this and from (5.20) we obtain

$$p(u_0, t) = v'(\xi(t), t) \rightarrow v'_0(\xi_0) = p_0(u_0),$$

which is what we wished to prove.

Uniform convergence for $u \in [u_1, u_2]$ will follow from the point convergence (5.19) if we can show that the derivatives $p'(u, t)$ are uniformly bounded for large t . Since

$$p'(u, t) = v''(x, t)/v'(x, t), \quad u = v(x, t),$$

boundedness of the derivatives then follows from the negativeness of $v'_0(x)$, the convergence (5.20), and the boundedness of $v''(x, t)$. This establishes the necessity part of the proof.

Let us assume the convergence (5.19) is valid. For an arbitrary interval $[y_1, y_2]$, indicated in the statement of the lemma, functions $p(u, t)$ are defined for sufficiently large t on the interval $[v_0(y_2), v_0(y_1)]$. It is easy to see that the following equalities are valid:

$$x - x_0 = \int_{v_*}^{v_0(x)} \frac{du}{p_0(u)}, \quad x - x_0 = \int_{v_*}^{v_0(x,t)} \frac{du}{p(u,t)}, \quad y_1 \leq x \leq y_2.$$

From this we obtain

$$\int_{v_0(x)}^{v_0(x,t)} \frac{du}{p(u,t)} = - \int_{v_*}^{v_0(x)} \frac{du}{p(u,t)} + \int_{v_*}^{v_0(x)} \frac{du}{p_0(u)}$$

and

$$(5.21) \quad |v(x, t) - v_0(x)| \leq \max_{u,t} |p(u, t)| \left| \int_{v_*}^{v_0(x)} \left(\frac{1}{p(u, t)} - \frac{1}{p_0(u)} \right) du \right|.$$

The uniform convergence (5.18) on the interval $[y_1, y_2]$ follows from the uniform convergence (5.19) on the interval $[v_0(y_2), v_0(y_1)]$ and the boundedness of the first factor on the right in (5.21). This completes the proof of the lemma. \square

PROPOSITION 5.2. *In order for a solution $u(x, t)$ of problem (5.2), (5.3) to approach a wave in form, it is necessary and sufficient that it approaches a wave in the phase plane.*

PROOF. Let

$$v(x, t) = u(x + m(t), t).$$

Assume that we have approach to a wave in form, i.e., that

$$(5.22) \quad v(x, t) \rightarrow w(x), \quad t \rightarrow \infty,$$

uniformly with respect to x , $-\infty < x < \infty$. From this we have

$$v_{\pm}(t) = \lim_{x \rightarrow \pm\infty} v(x, t) \rightarrow w_{\pm} \quad \text{as } t \rightarrow \infty$$

and, consequently, the convergence (5.17). Convergence (5.16) is a consequence of the preceding lemma.

Let the solution approach a wave in the phase plane. It follows from the convergence (5.17) that for sufficiently large t the function $p(u, t)$ is defined on an arbitrary interval embedding in the interval (w_+, w_-) . It follows from the preceding lemma that the convergence (5.22) is valid on an arbitrary finite interval. It follows from this and from the convergence (5.17) that we have uniform convergence on the whole axis, since wave $w(x)$ and function $v(x, t)$ are monotone in x . This completes the proof of the proposition. \square

We turn now to the problem concerning approach to a system of waves. Recall, from Definition 3.2 in §3.2, that a system of waves was introduced in the phase plane in the form of function $R(u)$, the graph of which consists of parts of trajectories of waves in the phase plane. It is therefore convenient to begin the definition of convergence of solutions of the Cauchy problem (5.2), (5.3) to a system of waves with convergence in the phase plane. This is completely analogous to Definition 5.3. Let us assume we are given a monotone system of waves $R(u)$ for $u \in [a, b]$, i.e., $R(u) \leq 0$. Moreover, we consider here only such systems of waves for which the equation $R(u_0) = 0$ implies that $F(u_0) = 0$. We remark that minimal and c -minimal systems of waves, which will be discussed later, satisfy this condition.

DEFINITION 5.4. We say that the solution $u(x, t)$ of problem (5.2), (5.3) approaches a system of waves in the phase plane if

$$(5.23) \quad p(u, t) \rightarrow R(u) \quad \text{as } t \rightarrow \infty, \quad u \in (a, b),$$

uniformly on each closed subset of interval (a, b) , and

$$(5.24) \quad u_+(t) \rightarrow a, \quad u_-(t) \rightarrow b \quad \text{as } t \rightarrow \infty.$$

We can also give a definition of approach to a system of waves in form, analogous to Definition 5.2. To do this, we note that a system of waves is a finite or infinite set of waves, i.e., solutions w of equation (5.1), satisfying the following conditions at infinities:

$$(5.25) \quad w(+\infty) = u_1, \quad w(-\infty) = u_2,$$

where $u_1 \leq u_2$, whereby, in case $u_1 = u_2$, we have a constant function $w(x) = u_1 = u_2$ for all x . In addition, $F(u_1) = 0$. We shall not include the degenerate waves $w(x) \equiv a$ and $w(x) \equiv b$ in the system of waves since the equations $u(x, t) = a$ and $u(x, t) = b$ can have no solutions, and, correspondingly, approach to these waves, in the sense indicated above, is undefined.

We denote waves satisfying conditions (5.25) by $w(x; u_1, u_2)$. As we have already noted, these waves, represented in the phase plane, constitute the graph of

function $R(u)$. Moreover, the waves-constants are points on the $p = 0$ axis, where these points can occupy an entire interval or set of intervals. For simplicity, we consider monotone solutions $u(x, t)$ of equation (5.2). Nonmonotone solutions, as well as nonmonotone waves, will be discussed in the supplement to the chapter (§6).

DEFINITION 5.5. We say that a solution $u(x, t)$ of problem (5.2), (5.3) approaches a system of waves in form if (5.24) is satisfied, and if, for an arbitrary wave $w(x; u_1, u_2)$ in the system of waves considered, we have the convergence

$$(5.26) \quad u(x + m(t), t) \rightarrow w(x; u_1, u_2) \quad \text{as } t \rightarrow \infty,$$

uniformly on each finite interval of the x -axis. Here $m(t)$ is a solution x of the equation

$$(5.27) \quad u(x, t) = u_0,$$

where $u_0 = u_1s + u_2(1 - s)$, s is an arbitrary fixed number from the interval $(0, 1)$.

Of course, a system of waves can consist of a single wave, and then Definition 5.5 must coincide with Definition 5.2. Nevertheless, there is a formal difference in these definitions. Namely, in Definition 5.2 uniform convergence is required on the whole axis. In Definition 5.5 the question concerns convergence on each finite interval and condition (5.24). However, recall that we are dealing here with solutions $u(x, t)$, monotone in x , and for approach to a wave both of these definitions are equivalent.

PROPOSITION 5.3. *If solution $u(x, t)$ of problem (5.2), (5.3) approaches a system of waves in the phase plane, then it approaches a system of waves in form.*

PROOF. For nondegenerate waves $w(x; u_1, u_2)$, $u_1 \neq u_2$, approaching a system of waves, Proposition 5.3 follows from Lemma 5.1. Assume, now, that $u_1 = u_2$, and, as was specified in the definition of systems of waves, $u_1 \neq a$, $u_1 \neq b$.

It is required to show that

$$(5.28) \quad u(x + m(t), t) \rightarrow u_1, \quad t \rightarrow \infty,$$

uniformly with respect to x on each finite interval, where $m(t)$ is the solution of equation $u(x, t) = u_1$. We select $N > 0$ arbitrary and we prove uniformity of the convergence (5.28) on the interval $[-N, 0]$. For the interval $[0, N]$ this is done in the same way.

We consider three cases: the system of waves $R(u)$ under consideration is negative in some right half-neighborhood of point u_1 ; $R(u) \equiv 0$ in some right half-neighborhood of point u_1 ; $R(u) \neq 0$ in the half-neighborhood indicated and there exists a sequence $\{v_n\}$, $v_n \searrow u_1$, for which $R(v_n) = 0$.

In the first case there exists a wave $w(x)$ from the system of waves, for which $w(+\infty) = u_1$. We denote the solution of the equation

$$u(x, t) = w_0,$$

where $w(+\infty) < w_0 < w(-\infty)$, by $m_1(t)$. Then if we assume that $w(0) = w_0$, the function

$$(5.29) \quad v_1(x, t) = u(x + m_1(t), t)$$

tends towards a wave uniformly on each finite interval. We show that this implies the convergence (5.28), uniformly on the interval $[-N, 0]$.

Let $\varepsilon > 0$. We denote by N_1 the solution of the equation

$$w(x) = u_1 + \delta/2.$$

For sufficiently large T we have the inequalities

$$(5.30) \quad u_1 < w(x) - \delta \leq v_1(x, t) \leq w(x) + \delta < u_1 + \varepsilon$$

for $t > T$, $N_1 \leq x \leq N_1 + N$, where $\delta = 0.5(w(N + N_1) - u_1)$. From the definition of $m(t)$ we have

$$(5.31) \quad u(m(t), t) = u_1.$$

We set

$$(5.32) \quad x_0(t) = m(t) - m_1(t).$$

Then from (5.29), (5.31), and (5.32) we obtain

$$(5.33) \quad v_1(x_0(t), t) = u_1.$$

From (5.29), (5.30), and (5.32) it follows that

$$(5.34) \quad u(N_1 + m(t) - x_0(t), t) < u_1 + \varepsilon.$$

On the other hand, from (5.30) and (5.33) we have

$$N + N_1 < x_0(t).$$

From this, and from (5.34), in view of the monotonicity of $u(x, t)$ with respect to x , we have

$$u(x + m(t), t) < u_1 + \varepsilon \quad \text{for} \quad x \geq -N, \quad t > T.$$

From equation (5.31) we conclude that

$$u(x + m(t), t) \geq u_1 \quad \text{for} \quad x \leq 0.$$

Thus we have established the uniform convergence (5.28) on the interval $[-N, 0]$.

Assume now that $R(u) \equiv 0$ for $u_1 \leq u \leq u_1 + \delta < b$ for some $\delta > 0$. We have

$$-N = \int_{u_1}^{u(-N+m(t), t)} \frac{du}{p(u, t)}.$$

Since $p(u, t) \rightarrow 0$ uniformly on the interval $[u_1, u_1 + \delta]$, then $u(-N + m(t), t) \rightarrow u_1$ as $t \rightarrow \infty$. As was the case above, the required convergence follows from the monotonicity of $u(x, t)$.

We consider the third case. For arbitrary $\varepsilon > 0$ we can find a u_0 , $u_1 < u_0 < u_1 + \varepsilon$, such that $R(u_0) < 0$, and, consequently, there exists a wave $w(x)$, from the system of waves considered, for which $u_1 < w(+\infty) < u_1 + \varepsilon$. From this point on, the discussion proceeds similarly to what was done in the first case. This completes the proof of the proposition. \square

5.2. Source of the first type (bistable case). Throughout this section we consider piecewise-continuous initial functions with a finite number of points of discontinuity and, for simplicity, monotone. If waves $w(x)$ have the limits w_+ and w_- as $x \rightarrow \pm\infty$, then an obvious necessary condition for approach to a wave in form is, by virtue of (5.17), that the values $f(\pm\infty)$ must be found in the domain of attraction of points w_+ and w_- relative to the equation

$$(5.35) \quad \frac{du}{dt} = F(u)$$

(see Theorem 4.2). We show here that this necessary condition is also sufficient for approach to a wave in form and speed for a source of the first type.

Let $q(x)$ be a solution of equation (5.1), monotonically decreasing for $x_1 < x < x_2$ and satisfying $q'(x_1) = q'(x_2) = 0$. Let $u_i = q(x_i)$, $i = 1, 2$ (we assume that $w_+ < u_i < w_-$), and introduce function $\tau(u)$, given for $u_2 \leq u \leq u_1$, which associates to each value of u the value $q'(x)$, where x is determined from the equation $q(x) = u$. Let $I(w_+)$ and $I(w_-)$ denote the domains of attraction of points $u = w_+$ and $u = w_-$ with respect to equation (5.35).

LEMMA 5.2. *For an arbitrary monotone initial condition $f(x)$, $f(+\infty) \in I(w_+)$, $f(-\infty) \in I(w_-)$, for sufficiently large t , we have the following inequality for the solution of problem (5.2), (5.3):*

$$(5.36) \quad p(u, t) \leq \tau(u), \quad u_2 \leq u \leq u_1.$$

PROOF. Let q_1 denote a solution of the equation

$$w'' + c_1 w' + F(w) = 0,$$

monotonically decreasing on the interval $x_3 < x < x_4$, with derivatives equal to zero at its endpoints, $q_1'(x_3) = q_1'(x_4) = 0$, and $q_1(x_3) = u_1$. Here $c_1 < c$ and the difference $c - c_1$ is sufficiently small. Existence of such a solution follows from a simple analysis of trajectories on the phase plane of the system of equations

$$(5.37) \quad w' = p, \quad p' = -c_1 p - F(u)$$

(here we need to take into account the fact that $F(u_2) < 0$). Moreover, if $\tau_1(u)$ is defined with respect to $q_1(x)$ (in the same way that $\tau(u)$ is defined with respect to $q(x)$), then, obviously, $\tau_1(u_3) = 0$, where $u_3 = q_1(x_4)$, $w_+ < u_3 < u_2$, and $\tau_1(u) \leq \tau(u)$ for $u_2 \leq u \leq u_1$.

Obviously, we can assume that $f(x)$ is a function which is smooth and strictly decreasing (otherwise, as a new initial condition, we would need to take function $u(x, t_0)$ for arbitrary $t_0 > 0$). Further, since the functions $u_{\pm}(t) (= \lim_{x \rightarrow \pm\infty} u(x, t))$ are defined and tend towards w_+ and w_- , respectively, we can assume also that $f(+\infty) < u_3$, $f(-\infty) > u_1$.

We consider function $q(x - ct + h)$ for $x_1 \leq x - ct + h \leq x_2$. It satisfies equation (5.2) and $q'(x_i) = 0$, $i = 1, 2$. If $q(x + h) \neq f(x)$ for $x_1 \leq x + h \leq x_2$, then, by virtue of Theorem 4.12, if for some value of x

$$q(x - ct + h) = u(x, t),$$

where $u(x, t)$ is a solution of Cauchy problem (5.2), (5.3), we have the inequality

$$q'(x - ct + h) \geq u'(x, t).$$

There is also a similar proposition for function q_1 .

Next, we consider a strip on the (x, u) -plane, bounded by the lines $u = u_1$ and $u = u_2$. We can fill this strip with curves of the form $(x, q(x+h))$, $x_1 - h \leq x \leq x_2 - h$, varying the displacement value h from $-\infty$ to $+\infty$. We vary h from $+\infty$ to h_0 , so that the inequality $q(x+h) < f(x)$ will be satisfied for all the values of x and h indicated above. Similarly, we fill the half-strip $u_3 \leq u \leq u_1$ with curves $(x, q_1(x+h))$, where $x_3 - h \leq x \leq x_4 - h$, with h varying from h_1 to $-\infty$ and $q_1(x+h) > f(x)$.

We now consider all the constructed functions $q(x+h)$ and $q_1(x+h)$ as initial conditions for equation (5.2), solutions of which are obtained from them by a displacement. Since $c_1 < c$, then, after a finite time, the two half-strips constructed above will be joined and the whole strip $u_2 \leq u \leq u_1$ will be filled up; in this strip, based on the aforesaid, we shall have the inequality $u'(x, t) \leq \max(\tau(u), \tau_1(u))$, where $u = u(x, t)$. This completes the proof of the lemma. \square

REMARK. The lemma remains valid if the derivatives $q'(x_i)$ are negative. Here one must require, in addition, that the following inequalities be satisfied:

$$p(u_i, t) < \tau(u_i), \quad t \geq 0, \quad i = 1, 2.$$

The lemma just proved is readily generalized by allowing x_1 to become $-\infty$ and x_2 to become $+\infty$. The resulting lemma is then somewhat weaker.

LEMMA 5.3. *Under the conditions of Lemma 5.2, for arbitrary $\varepsilon > 0$ we can find a $t(\varepsilon)$ such that*

$$p(u, t) \leq \tau(u) + \varepsilon, \quad u_2 \leq u \leq u_1,$$

for $t \geq t(\varepsilon)$.

PROOF. We consider a trajectory of system (5.37) for $c_1 \neq c$, for which the corresponding function $\tau_1(u)$ satisfies the following conditions. It is defined for $u_4 \leq u \leq u_3$, $\tau_1(u_3) = \tau_1(u_4) = 0$, $\tau_1(u) < 0$ for $u \in (u_4, u_3)$, the quantities $|u_1 - u_3|$ and $|u_2 - u_4|$ are sufficiently small,

$$\tau_1(u) \leq \tau(u) + \varepsilon, \quad u \in [u_2, u_1] \cap [u_4, u_3].$$

We consider different cases depending on the values of $F(u_i)$, $i = 1, 2$. Case $F(u_i) \neq 0$, $i = 1, 2$, was considered in Lemma 5.2. Let us assume that $F(u_1) \neq 0$ (consequently, $F(u_1) > 0$) and $F(u_2) = 0$. We take $c_1 > c$. If the difference $c_1 - c$ is sufficiently small, a trajectory leaving the point $u = u_1$, $p = 0$ then satisfies all the conditions listed. In case $F(u_1) = 0$, $F(u_2) \neq 0$ the trajectory in question comes into the point $u = u_2$, $p = 0$ for $c_1 < c$.

It remains to consider the case $F(u_1) = F(u_2) = 0$. If $c > 0$, then $F(u) \in l^+(u_1)$ (see Theorem 3.10) and a trajectory of system (5.37), leaving the stationary point $u = u_1$, $p = 0$, satisfies the required conditions if $c_1 > c$ and the difference $c_1 - c$ is sufficiently small. Analogous constructions may be carried out for the case $c < 0$, and also $c = 0$, if $F(u) \in l^+(u_1)$ or $F(u) \in r^-(u_2)$. If $c = 0$ and $F(u) \in l^-(u_1)$ or $F(u) \in r^+(u_2)$, then a (u_2, u_1) -wave cannot exist. It remains to consider the case $c = 0$ and $F(u) \in l^0(u_1)$, $F(u) \in r^0(u_2)$.

By Theorem 3.9 there exist, in this case, in an arbitrary left half-neighborhood of point u_1 , points of positiveness of function $F(u)$. We consider all possible waves $w(x; a_n, b_n)$ with zero speed for which $a_n, b_n \in (u_2, u_1)$ and $F(u) \in l^+(b_n)$, and corresponding functions $\tau(u; a_n, b_n)$. We show that for some sequence $\{b_n\}$,

converging to u_1 , the corresponding sequence $\{a_n\}$ converges to u_2 . If we can show this, then we can take function $\tau(u; a_n, b_n)$ sufficiently close to $\tau(u)$ and carry out the constructions indicated above for it.

Let us suppose that the stated proposition is not valid and that $a_n \not\rightarrow u_2$ for any sequence. We take an arbitrary value $b \in (u_2, u_1)$ for which $F(u) \in l^+(b)$ and we let

$$a = \inf_{u_1 > b_n > b} a_n.$$

Then $a > u_2$. Indeed, if this is not the case and $a = u_2$, there then exists a sequence $\{a_n\}$ converging to u_2 . The corresponding sequence $\{b_n\}$ can also be considered convergent to some value b_0 . If $b_0 = u_1$, then this contradicts the supposition made; if $b_0 < u_1$, then

$$\int_{u_2}^{b_0} F(u) du = 0,$$

which contradicts the existence of a (u_2, u_1) -wave.

According to the definition of number a there exists a wave $w(x; a, \bar{b})$ for some $\bar{b} \geq b$. It is easy to see that for all $b_n > \bar{b}$ we have the inequality $a_n \geq \bar{b}$. Indeed, if for some $b_n > \bar{b}$ the inequality $a_n < \bar{b}$ is satisfied, then

$$\int_{a_n}^{\bar{b}} F(u) du < 0,$$

which contradicts the existence of an (a, \bar{b}) -wave, since $a_n \geq a$.

Consider the integral

$$J = \int_{\bar{b}}^{u_1} F(u) du.$$

From the existence of a (u_2, u_1) -wave it follows that $J > 0$. Let us denote by \mathfrak{M} the union of all intervals $[a_n, b_n]$ for $b_n > \bar{b}$. Since

$$\int_{a_n}^{b_n} F(u) du = 0,$$

then

$$\int_{\mathfrak{M}} F(u) du = 0.$$

Since all points at which function $F(u)$ is positive on the interval $[\bar{b}, u_1]$ belong to the set \mathfrak{M} , it then follows from the last equation that $J \leq 0$. The resulting contradiction establishes the proposition.

Thus, structure of function $q_1(x)$ has been described in all cases. Further proof is carried out similar to the proof of Lemma 5.3. We need only remark that if $q_1(x)$ is defined on a semi-axis or on an axis, then the equation $f(x) = q_1(x+h)$ can have a solution for arbitrary h . However, for $|h|$ sufficiently large, $q_1(x+h) - f(x) \in A_0$, since we can, without loss of generality, assume that $f(x)$ is a smooth function with a negative derivative and $f(+\infty) < u_2$, $u_1 < f(-\infty)$. A similar remark applies to function $q(x)$. This completes the proof of the lemma. \square

Before stating the main theorem of this section, we give, without proof, one more simple lemma and we prove a proposition important in the sequel.

LEMMA 5.4. *If solution $u(x, t)$ of the Cauchy problem (5.2), (5.3) approaches in form a monotone function $g(x)$, given on interval $x_1 \leq x \leq x_2$, i.e., as $t \rightarrow \infty$*

$$u(x + m(t), t) \rightarrow g(x),$$

uniformly with respect to x , where $m(t)$ is a solution of the equation

$$u(x_0 + m(t), t) = g(x_0), \quad x_1 < x_0 < x_2,$$

and $u(x, t)$ has derivatives u' , u'' , u''' , uniformly bounded with respect to x and $t \geq t_0 > 0$, then $g(x)$ is a twice continuously differentiable function and it satisfies equation (5.1) for some c .

PROPOSITION 5.4. *Let the numbers χ_+ and χ_- belong to the domain of attraction of the stationary points w_+ and w_- of equation (5.35), and let $\chi_+ \leq w_+$, $\chi_- \geq w_-$. Assume, further, that $\chi(x)$ is equal to χ_+ for $x > 0$ and to χ_- for $x \leq 0$. Then function $p(u, t; \chi)$ is nonmonotonically nondecreasing on the interval $[w_+, w_-]$ and converges uniformly on this interval to a minimal system of waves.*

PROOF. It is easy to see that the functions $u_{\pm}(t; \chi)$ converge to w_{\pm} monotonically. Therefore, we can prove, in exactly the same way as in Corollary 2 to Theorem 4.1, that $p(t, u; \chi)$ is monotone nondecreasing. Consequently, it converges uniformly to some function $r(u)$ on the interval $[w_+, w_-]$. It follows from Lemma 5.1 and Lemma 5.4 that $r(u)$ is a system of waves. It remains to show that it is a minimal system of waves. Let us suppose the contrary to be so:

$$(5.38) \quad R_0(u_0) < r(u_0)$$

for some $u_0 \in (w_+, w_-)$ and a minimal system of waves $R_0(u)$. Let $u_0 \in (u_1, u_2)$, where $R_0(u_1) = R_0(u_2) = 0$, $R_0(u) < 0$ for $u \in (u_1, u_2)$. Then, on the basis of comparison theorems in the phase plane (§4), we obtain

$$p(t, u_0; \chi) \leq R_0(u_0),$$

which, in the limit as $t \rightarrow \infty$, contradicts (5.38). The proposition is thereby proved. \square

THEOREM 5.1. *Let $f(x)$ be a monotone, piecewise continuous function with a finite number of points of discontinuity. Further, suppose that there exists a unique monotone wave $w(x)$, satisfying the conditions at infinity $w(\pm\infty) = w_{\pm}$.*

In order that solution $u(x, t)$ of the Cauchy problem (5.2), (5.3) approach wave $w(x)$ in form and speed, it is necessary and sufficient that the values $f(\pm\infty)$ belong to the domain of attraction of the points w_{\pm} with respect to equation (5.35).

REMARK. Conditions for uniqueness of a wave with given values at infinity are equivalent to the fact that w_{\pm} are not points of repulsion on the interval $w_+ \leq w \leq w_-$, i.e., $F(u)$ is a source of the first kind on this interval.

In the statement of the theorem the inequality $w_+ \leq f(x) \leq w_-$ is not required and nonstrict monotonicity of the initial function is allowed.

PROOF. Necessity of the condition $f(\pm\infty) \in I(w_{\pm})$, as already noted at the beginning of this section, follows from Theorem 4.2.

We now prove sufficiency of this condition. To do this, we verify the convergences (5.16) and (5.17). Convergence (5.17) follows, obviously, also from

Theorem 4.2. To prove (5.16) it is sufficient to verify, for arbitrary positive ε and δ , sufficiently small, that we can find a value of $t_0(\varepsilon, \delta)$, such that

$$(5.39) \quad p_0(u) - \varepsilon \leq p(u, t) \leq p_0(u) + \varepsilon, \quad w_+ + \delta \leq u \leq w_- - \delta, \quad t \geq t_0.$$

The inequality on the right in (5.39) follows from Lemmas 5.2 and 5.3. Function $q(x)$ and function $\tau(u)$, corresponding to it, which are involved in the lemmas, can be constructed in the following way. On the phase plane of the system of equations

$$(5.40) \quad w' = p, \quad p' = -cp - F(w),$$

where c is the speed of the wave, we consider trajectories and functions $p(u)$ corresponding to them. We take an arbitrary point $(u_0, p_0(u_0) + \sigma)$, where $w_+ < u_0 < w_-$, σ is a small positive number, and we determine function $\tau(u)$ on an arc of the trajectory passing through this point and located in the half-plane $p \leq 0$. Then $p_0(u) < \tau(u)$ at the location where the last function is defined; $\tau(u)$ tends towards $p_0(u)$ as σ decreases, uniformly with respect to u , on the interval $[w_+ + \delta, w_- - \delta]$, where function $\tau(u)$ vanishes at the points $u = u_i$, $i = 1, 2$, located inside the interval, i.e., $w_+ < u_2$, $u_1 < w_-$. This follows from properties of sources of the first type on the interval $[w_+, w_-]$, for which only one trajectory comes into a stationary point (see Theorems 3.4 and 3.5).

In proving the inequality on the left in (5.39), we make use of Proposition 5.4, in which we now need to define function $\chi(x)$ by the equation

$$\chi(x) = \begin{cases} \chi_+ & \text{for } x > 0, \\ \chi_- & \text{for } x \leq 0, \end{cases}$$

where $\chi_+ = \min\{w_+, f_+\}$, $\chi_- = \max\{w_-, f_-\}$. Validity of the inequality on the left in (5.39) follows, by virtue of this proposition, from the fact that a minimal system of waves in the case considered coincides with a wave and $p(t, u; \chi) \leq p(t, u; f)$ for $u \in [w_+ + \delta, w_- - \delta]$ and sufficiently large t . This completes the proof of the theorem. \square

This theorem characterizes fairly completely the behavior of solutions of the Cauchy problem in the case of sources of the first type, if a wave exists. An analogous theorem holds for a minimal system of waves.

THEOREM 5.2. *Let function $f(x)$ satisfy the condition of the preceding theorem. Further, let $F(u)$ be a source of the first type on the interval $w_+ \leq u \leq w_-$.*

In order that the solution $u(x, t)$ of the Cauchy problem (5.2), (5.3) approach a minimal system of waves on this interval, it is necessary and sufficient that the values $f(\pm\infty)$ belong to the domain of attraction of points w_{\pm} with respect to the equation (5.35).

PROOF. We must add only one remark here to the proof of the preceding theorem, involving the "inner" waves of the system of waves, i.e., the waves $w(x; u_1, u_2)$, $w_+ < u_1, u_2 < w_-$, $u_1 \neq u_2$. Here, in order to prove the inequality on the right in (5.39) we can use the inequality

$$p(t, u; f) \leq p(t, u; f_0), \quad u_1 \leq u \leq u_2,$$

where

$$f_0(x) = \begin{cases} u_2 & \text{for } f(x) \geq u_2, \\ f(x) & \text{for } u_1 < f(x) < u_2, \\ u_1 & \text{for } f(x) \leq u_1, \end{cases}$$

and the convergence

$$p(t, u; f_0) \rightarrow \tau(u; u_1, u_2), \quad t \rightarrow \infty$$

($\tau(u; u_1, u_2) = w'(x; u_1, u_2)$, $u = w(x; u_1, u_2)$), which is valid on the basis of the preceding theorem. This completes the proof of the theorem. \square

In concluding this section we turn our attention to the question concerning instability of nonmonotone waves (see [Hag 1]).

THEOREM 5.3. *A nonmonotone wave $w(x)$ is not stable with respect to small perturbations from $C(-\infty, +\infty)$.*

PROOF. Consider the function

$$f(x) = \max(w(x), w(x - h)),$$

where h is a sufficiently small number. Then for all x

$$f(x) \geq w(x), \quad f(x) \geq w(x - h),$$

and, on the basis of Corollary 4 to Theorem 3.2,

$$f(x) \not\equiv w(x), \quad f(x) \not\equiv w(x - h).$$

Therefore, $f(x)$ is a lower function and the solution $u(x, t)$ of the Cauchy problem

$$\frac{\partial u}{\partial t} = \frac{\partial^2 u}{\partial x^2} + c \frac{\partial u}{\partial x} + F(u), \quad u(x, 0) = f(x),$$

where c is the speed of wave $w(x)$, increases monotonically with respect to t . By the aforementioned corollary, $u(x, t)$ cannot tend towards $w(x - \tau)$ for any value of τ . This completes the proof of the theorem. \square

REMARK. If wave $w(x)$ has more than one extremum, it is then not stable, even with respect to perturbations with finite support.

5.3. Exponent \varkappa . Before going on to the problem concerning approach to a wave or system of waves for sources of the second and third types, we need to introduce an exponent characterizing the behavior of the initial function at infinity. This will be done in the present section. Let $f(x)$ be a function given on some semi-axis $x \geq x_0$; we assume that $f(x)$ is positive and tends towards zero as $x \rightarrow \infty$. Its behavior at infinity will be characterized with the aid of function $\Phi(u)$, which we assume to be given on the semi-axis $u > 0$ and monotonically increasing. In the sequel we shall take specific functions for $\Phi(u)$, but for the present treatment we use an arbitrary function $\Phi(u)$ with the indicated properties.

Given function $f(x)$ we construct, with the aid of function $\Phi(u)$, a symmetric function of two variables x_1, x_2 for $x_1 > x_0, x_2 > x_0$:

$$f_{\Phi}(x_1, x_2) = \frac{\Phi(f(x_1)) - \Phi(f(x_2))}{x_1 - x_2} \quad (x_1 \neq x_2).$$

DEFINITION 5.6.

$$\overline{\varkappa}[f] = \overline{\lim}_{x_1, x_2 \rightarrow \infty} f_{\Phi}(x_1, x_2),$$

$$\underline{\varkappa}[f] = \underline{\lim}_{x_1, x_2 \rightarrow \infty} f_{\Phi}(x_1, x_2).$$

If $\overline{\varkappa}[f] = \underline{\varkappa}[f]$, we say that there exists a strict exponent $\varkappa[f]$, defined by the equation

$$\varkappa[f] = \lim_{x_1, x_2 \rightarrow \infty} f_{\Phi}(x_1, x_2).$$

We present several propositions relating to the exponent \varkappa , defined in this way.

PROPOSITION 5.5. *We have the following equalities:*

$$(5.41) \quad \begin{aligned} \overline{\varkappa}[f] &= \overline{\lim}_{x \rightarrow \infty, h \rightarrow 0} f_{\Phi}(x+h, x), \\ \underline{\varkappa}[f] &= \underline{\lim}_{x \rightarrow \infty, h \rightarrow 0} f_{\Phi}(x+h, x), \\ \varkappa[f] &= \lim_{x \rightarrow \infty, h \rightarrow 0} f_{\Phi}(x+h, x). \end{aligned}$$

PROOF. We prove the first of the equalities (5.41). The second equation is proved in a similar way, while the third is obviously a consequence of the first two. We denote the right side of the first of equalities (5.41) by $\overline{\nu}[f]$. It follows directly from the definition that $\overline{\nu}[f] \leq \overline{\varkappa}[f]$. We prove the opposite inequality. Let the following sequence of numbers be given:

$$x_0 < x_1 = \xi_1 < \xi_2 < \cdots < \xi_n = x_2.$$

Obviously,

$$(5.42) \quad f_{\Phi}(x_1, x_2) = \frac{1}{x_2 - x_1} \sum_{k=1}^{n-1} f_{\Phi}(\xi_k, \xi_{k+1})(\xi_{k+1} - \xi_k).$$

From this we obtain, for $x_1 > N, \xi_{k+1} - \xi_k < \delta$,

$$f_{\Phi}(x_1, x_2) \leq \sup_{x > N, |h| < \delta} f_{\Phi}(x+h, x),$$

and, consequently, $\overline{\nu}[f] \leq \overline{\varkappa}[f]$. The proposition is thereby proved. \square

From this proposition we readily obtain the following proposition.

PROPOSITION 5.6. *If $f(x)$ is an absolutely continuous function on the semi-axis $x > x_0$, and $\Phi(u)$ has a continuous derivative, then*

$$(5.43) \quad \begin{aligned} \overline{\varkappa}[f] &= \overline{\lim}_{x \in M, x \rightarrow \infty} \frac{d\Phi(f(x))}{dx}, \\ \underline{\varkappa}[f] &= \underline{\lim}_{x \in M, x \rightarrow \infty} \frac{d\Phi(f(x))}{dx}, \\ \varkappa[f] &= \lim_{x \in M, x \rightarrow \infty} \frac{d\Phi(f(x))}{dx}, \end{aligned}$$

where M is an arbitrary set of full measure on the semi-axis $x > x_0$, contained in the set of points on which the derivative of function $f(x)$ exists.

PROPOSITION 5.7. *We have the following inequalities:*

$$(5.44) \quad \overline{\lim}_{x \rightarrow \infty} \frac{\Phi(f(x))}{x} \leq \overline{\varkappa}[f], \quad \underline{\lim}_{x \rightarrow \infty} \frac{\Phi(f(x))}{x} \geq \underline{\varkappa}[f].$$

If the strict exponent $\varkappa[f]$ exists, we then have the limit

$$(5.45) \quad \lim_{x \rightarrow \infty} \frac{\Phi(f(x))}{x} = \varkappa[f].$$

PROOF. Inequalities (5.44) are obtained directly from the definitions, and the limit (5.45) follows from them.

If, in particular, as $\Phi(u)$ we take the function $\ln u$, then this proposition implies a relationship between the Lyapunov exponent and \varkappa . In particular, if the strict exponent \varkappa exists, then the strict Lyapunov exponent exists and they are equal.

Using the exponent \varkappa , we can compare the behavior of functions at ∞ . Thus if we are given two functions $f_1(x)$ and $f_2(x)$ with the properties indicated and

$$(5.46) \quad \overline{\varkappa}[f_1] < \underline{\varkappa}[f_2],$$

then, for all sufficiently large x ,

$$(5.47) \quad f_1(x) < f_2(x).$$

Indeed, it follows from (5.44) that

$$\overline{\lim}_{x \rightarrow \infty} \frac{\Phi(f_1(x))}{x} < \underline{\lim}_{x \rightarrow \infty} \frac{\Phi(f_2(x))}{x},$$

so that, for sufficiently large x ,

$$\Phi(f_1(x)) < \Phi(f_2(x)),$$

whence (5.47) follows. □

The following result, more specific for exponent \varkappa , is needed for the sequel.

PROPOSITION 5.8. *If $f_i(x)$, $i = 1, 2$, are two functions, given on the x -axis, positive, nonincreasing, and tending towards zero as $x \rightarrow \infty$, and if they satisfy inequality (5.46) at $+\infty$ and inequality $f_2(-\infty) < f_1(-\infty)$ at $-\infty$, then there exists a number h_0 such that for each $h \geq h_0$ the function*

$$(5.48) \quad f_2(x+h) - f_1(x)$$

belongs to class A on the x -axis.

PROOF. Let $\varepsilon < 0.5(\underline{z}[f_2] - \overline{z}[f_1])$. Then there exists a number N , such that for $x_1 > N$, $x_2 > N$,

$$f_{1\Phi}(x_1, x_2) < \overline{z}[f_1] + \varepsilon, \quad f_{2\Phi}(x_1, x_2) > \underline{z}[f_2] - \varepsilon.$$

It is obvious that for $h > 0$

$$f_{2\Phi}(x_1 + h, x_2 + h) > \underline{z}[f_2] - \varepsilon.$$

Thus, for $x_1 > x_2 > N$ and $h > 0$ we have

$$\Phi(f_1(x_1)) - \Phi(f_1(x_2)) < \Phi(f_2(x_1 + h)) - \Phi(f_2(x_2 + h)),$$

or

$$\Phi(f_2(x_1 + h_1)) - \Phi(f_1(x_1)) > \Phi(f_2(x_2 + h)) - \Phi(f_1(x_2)).$$

This means that if function (5.48) is positive for $x = x_2$, it is then also positive for $x = x_1 > x_2$, and if function (5.48) is negative for $x = x_1$, then it is also negative for $x = x_2 < x_1$. But, by definition, this means that function (5.48) belongs to class A on the semi-axis $x > N$ for all $h > 0$.

We now select number h_0 indicated in the statement of the proposition. Let x_1 and x_2 be numbers for which the following inequalities are satisfied: $x_1 < N < x_2$, $f_1(x_1) > f_2(-\infty)$, $f_2(x_2) < f_1(N)$, and let us set $h_0 = x_2 - x_1$. Then, as can easily be verified, for $h \geq h_0$ function (5.48) is negative for $x \leq N$, and, as was shown above, belongs to class A for $x > N$. Consequently, it belongs to class A on the whole axis. This completes the proof of the proposition. \square

In the sequel, we shall use exponents \varkappa constructed with respect to two functions Φ : $\ln u$ and $(1 - n)^{-1}u^{1-n}$ ($n > 1$), and we denote these exponents by $\overline{\varkappa}_n[f]$, $\underline{\varkappa}_n[f]$, and $\varkappa_n[f]$ ($n \geq 1$), where, for $n > 1$, we assume that $\Phi(u) = (1 - n)^{-1}u^{1-n}$, and for $n = 1$, $\Phi(u) = \ln u$. Thus, on the basis of Proposition 5.6, if function $f(x)$ has a bounded derivative, then

$$(5.49) \quad \overline{\varkappa}_n[f] = \overline{\lim}_{x \rightarrow \infty} \frac{f'(x)}{f^n(x)}, \quad \varkappa_n[f] = \lim_{x \rightarrow \infty} \frac{f'(x)}{f^n(x)} \quad (n \geq 1).$$

5.4. Sources of the second and third types (monostable and unstable cases). For sources of the second and third types, waves and systems of waves determining the behavior of solutions for large times are nonunique, and the approach of a solution to this or another wave or system of waves depend on the behavior of the initial function as $x \rightarrow \infty$. This means that for each wave, for example, there exists a class of initial functions from which a solution approaches this wave. If the aim is not to include the broadest class of functions, it is then fairly simple to describe the behavior of solutions for the case being considered. In broadening the class of initial conditions specific complications appear. We therefore confine ourselves not to the most general classes of functions, but to classes which, however, characterize the behavior of solutions practically completely. Results obtained for the most general classes of functions will be presented in §6.

In this section we shall consider piecewise-continuous initial functions with a finite number of points of discontinuity. As was the case above, we limit ourselves here to monotone initial conditions. We consider first the case in which wave $w(x)$ exists with the conditions $w(\pm\infty) = w_{\pm}$ and the source $F(u)$ is a source of the second type on interval $w_+ \leq u \leq w_-$. In this case waves exist for positive or negative speeds, depending on the sign of function $F(u)$ close to the points w_+ and

w_- . We shall assume, for example, that a source is positive in a half-neighborhood of these points (the other case is obtained from this by a change of variables). Then the waves $w_c(x)$, $w_c(\pm\infty) = w_{\pm}$ exist for a half-interval (semi-axis) of speeds $c_0 \leq c < c^*$, where $0 < c_0 < c^* \leq +\infty$ (Theorem 3.14).

We assume that source $F(u)$ satisfies the condition

$$(5.50) \quad \lim_{u \rightarrow w_+} \frac{F(u)}{(u - w_+)^n} = \alpha_n.$$

Here $n \geq 1$, and α_n is a positive number. Let $\alpha = F'(w_+)$, so that $\alpha = \alpha_1$. It is obvious that for $n > 1$, $\alpha = 0$, and, thus, we consider the case when $F'(w_+) = 0$.

Recall that for a wave with minimal speed c_0

$$(5.51) \quad \lim_{x \rightarrow \infty} \frac{w'_{c_0}(x)}{w_{c_0}(x) - w_+} = -\frac{c_0}{2} - \sqrt{\frac{c_0^2}{4} - \alpha};$$

for waves with nonminimal speeds c

$$(5.52) \quad \lim_{x \rightarrow \infty} \frac{w'_{c_0}(x)}{(w_{c_0}(x) - w_+)^n} = -\lambda_n(c),$$

where we have set

$$(5.53) \quad \lambda_n(c) = \frac{\alpha_n}{\frac{c}{2} + \left(\frac{c^2}{4} - \alpha\right)^{1/2}}$$

(Theorem 3.4).

We show now that solution $u(x, t; f)$ of the Cauchy problem (5.2), (5.3) approaches a wave with speed c determined by the behavior of $f(x)$ at $+\infty$.

It follows from (5.49) and (5.52) that for waves $w_c(x)$ with nonminimal speed c behavior at $+\infty$ is determined by the exponent \varkappa_n :

$$(5.54) \quad \varkappa_n[w_c - w_+] = -\lambda_n(c).$$

We formulate a theorem relating to approach to a wave.

THEOREM 5.4. *Let $f(x) \geq w_+$ for $x \in (-\infty, +\infty)$ and let $f(-\infty)$ lie in the domain of attraction of point w_- relative to equation (5.35). Then*

1. *If $f(x) \equiv w_+$ on some semi-axis $x \geq x_0$ or $f(x) > w_+$ and*

$$(5.55) \quad \varkappa_n[f - w_+] \leq -\lambda_n(c_0), \quad n \geq 1,$$

then the solution of the Cauchy problem (5.2), (5.3) approaches minimal wave $w_{c_0}(x)$ in form and speed.

2. *If $f(x) > w_+$, the exponent $\varkappa_n[f - w_n]$ is strict and*

$$(5.56) \quad \varkappa_n[f - w_+] = -\lambda_n(c), \quad n \geq 1,$$

where $c_0 < c < c^$, then solution $u(x, t; f)$ approaches wave $w_c(x)$ in form and speed.*

We preclude the proof of this theorem with the following lemma.

LEMMA 5.5. *There exists a solution $q = q(x)$ of equation*

$$(5.57) \quad q'' + cq' + F(q) = 0$$

for $c_0 < c < c^*$ on semi-axis $x \geq 0$, satisfying the following conditions:

$$(5.58) \quad w_+ \leq q(x) \quad \text{for} \quad x \geq 0,$$

$$(5.59) \quad q'(x) < 0 \quad \text{for} \quad x > 0,$$

$$(5.60) \quad \lim q(x) = w_+ \quad \text{as} \quad x \rightarrow \infty,$$

$$(5.61) \quad \lim_{x \rightarrow \infty} \frac{q'(x)}{(q(x) - w_+)^n} = -\lambda_n(c),$$

$$(5.62) \quad q(0) = w_*, \quad q'(0) < 0$$

for arbitrary $w_* \geq w_-$ lying in the domain of attraction of the stationary point w_- of equation (5.35), or

$$(5.63) \quad q(0) = w_0, \quad q'(0) = 0$$

for arbitrary $w_0 \in (w_+, w_-)$, sufficiently close to w_+ or w_- .

PROOF. We consider a solution of the system

$$(5.64) \quad u' = p, \quad p' + cp + F(u) = 0$$

with the initial condition $u = w_-, p = -\nu$, where $\nu > 0$ is a given sufficiently small number. On the phase plane the corresponding curve lies between wave $p_c(u)$ and the solution of system (5.64), coming into point $(w_+, 0)$ in a low direction. Therefore, the curve corresponding to the solution being considered comes into point $(w_+, 0)$ in a high direction, since only one trajectory comes in a low direction. If $w_* > w_-$, we then extend this trajectory for $u > w_-$ to the point w_* . Since, by hypothesis, $F(u) < 0$ for all these u , the trajectory so extended then does not intersect the $p = 0$ axis. Upon making a translation with respect to x , we obtain a solution satisfying conditions (5.58)–(5.62).

In order to construct a solution satisfying condition (5.63), we consider a trajectory of system (5.64) leaving point $(w_0, 0)$. If w_0 is sufficiently close to w_+ , then $F(w) > 0$ for $w_+ < w \leq w_0$ and, therefore, this trajectory comes into the point $(w_+, 0)$. If w_0 is sufficiently close to w_- , the trajectory then hits the point $(w_+, 0)$ owing to proximity to the trajectory corresponding to wave w_c . This establishes the lemma. \square

We denote by q_c the solution (5.57) with conditions (5.58)–(5.62), by \bar{q}_c the solution of this equation with conditions (5.58)–(5.61) and (5.63), and by $p = \tau_c(u)$ and $p = \bar{\tau}_c(u)$ the corresponding trajectories on the phase plane (u, p) of system (5.64).

LEMMA 5.6. *Let c_1 and c_2 be given numbers: $c_1 > c_2 > c_0$, and let a number h_0 be found such that the initial function $f(x)$ satisfies the conditions*

$$(5.65) \quad \bar{q}_{c_1}(x+h) - f(x) \in A_0 \quad \text{for } x \geq -h,$$

$$(5.66) \quad q_{c_2}(x-h) > f(x) \quad \text{for } x \geq h,$$

for $h \geq h_0$. If $w_* \geq f(-\infty)$, $w_0 < f(-\infty)$, there then exists a number $T(c_1, c_2)$ such that

$$(5.67) \quad p(u, t; f) \leq \bar{\tau}_{c_1}(u), \quad w_+ \leq u \leq w_0,$$

for $t > T(c_1, c_2)$ and

$$(5.68) \quad u(x, t; f) < q_{c_2}(x - c_2t - h) \quad \text{for } t > 0, \quad h \geq h_0, \quad x > c_2t + h.$$

PROOF. Functions

$$(5.69) \quad u_{1h}(x, t) = \bar{q}_{c_1}(x + h - c_1t) \quad \text{and} \quad u_{2h}(x, t) = q_{c_2}(x - h - c_2t)$$

are solutions of equation (5.2) for $t > 0$ in the domains

$$(5.70) \quad x + h - c_1t > 0 \quad \text{and} \quad x - h - c_2t > 0,$$

correspondingly, with boundary conditions

$$u'_{1h}(x, t) = 0 \quad \text{for } x = c_1t - h,$$

$$u_{2h}(x, t) = w_* \quad \text{for } x = c_2t + h.$$

Functions

$$(5.71) \quad v_{ih}(x, t) = u_{ih}(x, t) - u(x, t; f) \quad (i = 1, 2)$$

are solutions of equation (4.5) for $a(x, t) = 0$ and $b(x, t)$ selected accordingly. It is easy to see that in domains (5.70) the conditions for Theorem 4.10 are satisfied for v_{1h} and for Theorem 4.8 for v_{2h} . It is assumed here that $h \geq h_1$, where $h_1 \geq h_0$, taken so large that $\bar{q}_{c_1}(0) < f(-h)$ (see Remark before Theorem 4.10).

In accordance with these theorems we find, taking (5.65) and (5.66) into account, that for each $t > 0$

$$(5.72) \quad u_{1h}(x, t) - u(x, t; f) \in A \quad (h \geq h_1),$$

$$(5.73) \quad u_{2h}(x, t) - u(x, t; f) > 0 \quad (h \geq h_0),$$

on the semi-axes $x > c_1t - h$ and $x > c_2t + h$. This establishes (5.68).

Assume now that u_0 is an arbitrary number from the half-open interval $(w_+, w_0]$. For each $t > 0$ we denote by $x_0 = x_0(t)$ the solution of the equation

$$(5.74) \quad u_0 = u(x_0, t; f).$$

We show that a number T can be found, independent of u_0 , such that for all $t > T$ there exists an $h = h(t) \geq h_1$ for which

$$(5.75) \quad u_0 = u_{1h}(x_0, t).$$

Relation (5.67) obviously follows from this by virtue of (5.72). Thus, to complete the proof of the lemma, it only remains to prove that the choice of T is possible.

We denote by $x_1(u)$ and $x_2(u)$ solutions of the equations

$$(5.76) \quad \bar{q}_{c_1}(x_1) = u \quad \text{and} \quad q_{c_2}(x_2) = u$$

for $u \in (w_+, w_0]$. Obviously, as solution h of equation (5.75) we have the number

$$(5.77) \quad h = x_1(u_0) - x_0 + c_1 t.$$

Since $u_{2h}(x_2(u_0) + h_1 + c_2 t, t) = u_0$, then, by virtue of inequality (5.73), we have, for each t ,

$$x_2(u_0) + h_1 + c_2 t \geq x_0.$$

From this and from (5.77) we have

$$(5.78) \quad h > x_1(u_0) - x_2(u_0) - h_1 + (c_1 - c_2)t.$$

We note that numbers x_* and u_* can obviously be found such that $q_{c_2}(x_*) = \bar{q}_{c_1}(x_*) = u_*$ and $q_{c_2}(x) < \bar{q}_{c_1}(x)$ for $x > x_*$. It follows from this that $x_2(u) - x_1(u)$ is negative for $u \in (w_+, u_*)$. Therefore, $x_2(u) - x_1(u)$ is bounded from above for all $u \in (w_+, w_0]$ and, by virtue of (5.78), number T can be chosen so that $h \geq h_1$ for $t > T$. This completes the proof of the lemma. \square

LEMMA 5.7. *Let c_1 and c_2 be given numbers, $c_0 < c_2 < c_1 < c^*$, and assume that a number h_0 can be found such that the initial function $f(x)$ satisfies the conditions*

$$(5.79) \quad f(x) > \bar{q}_{c_1}(x + h) \quad \text{for} \quad x \geq -h,$$

$$(5.80) \quad f(x) - q_{c_2}(x - h) \in A_0 \quad \text{for} \quad x \geq h, \quad h \geq h_0.$$

If $w_0 < f(-\infty) \leq w_*$, then

$$(5.81) \quad u(x, t; f) > \bar{q}_{c_1}(x + h - c_1 t)$$

for $t > 0$, $h \geq h_0$, $x > c_1 t - h$, and a number $T(c_1, c_2)$ can be found such that

$$(5.82) \quad p(u, t; f) \geq \tau_{c_2}(u) \quad \text{for} \quad w_+ \leq u \leq w_0, \quad t \geq T(c_1, c_2).$$

PROOF. As in the proof of the preceding lemma, we consider functions (5.69). Functions

$$v_{ih}(x, t) = u(x, t; f) - u_{ih}(x, t), \quad i = 1, 2,$$

are solutions of equation (4.5).

To the function $v_{1h}(x, t)$ we can apply the corollary to Theorem 4.8 in domain D bounded by the lines $t = 0$, $x + h - c_1 t = 0$, from whence (5.81) follows. To function $v_{2h}(x, t)$ we apply Theorem 4.9 in domain D bounded by the lines $t = 0$, $x - h - c_2 t = 0$. It follows from this that

$$(5.83) \quad u(x, t; f) - u_{2h}(x, t) \in A \quad (h \geq h_0)$$

on line $x > c_2 t + h$.

Let $u_0 \in (w_+, w_0]$, x_0 being determined from equation (5.74). As in the preceding lemma, it can be proved that a number T can be found, independent of u_0 , such that for $t > T$ there exists an $h = h(t) \geq h_0$ for which $u_{2h}(x_0, t) = u_0$.

It follows from this and from (5.83) that (5.82) is valid. The lemma is thereby established. \square

LEMMA 5.8. *If $f(x) \equiv w_+$ for $x > x_0$ and $f(x_0) > w_+$ or $f(x) > w_+$ and*

$$(5.84) \quad \overline{\varkappa}_n[f - w_+] \leq -\lambda_n(c) \quad \text{for} \quad c_0 \leq c < c^*,$$

then

$$(5.85) \quad \overline{\lim}_{t \rightarrow \infty} \overline{\varkappa}_n[u(\cdot, t; f) - w_+] \leq -\lambda_n(c).$$

If $f(x) > w_+$ and

$$\underline{\varkappa}_n[f - w_+] \geq -\lambda_n(c) \quad \text{for} \quad c_0 < c < c^*,$$

then

$$(5.86) \quad \underline{\lim}_{t \rightarrow \infty} \underline{\varkappa}_n[u(\cdot, t; f) - w_+] \geq -\lambda_n(c).$$

PROOF. Consider the case in which $f(x) > w_+$ and (5.84) holds. Let $c_1 > c_2 > c$, \overline{q}_{c_1} , q_{c_2} are solutions of equation (5.57) indicated above. Let us apply Proposition 5.8 to the functions $f_1(x) = f(x)$, $f_2(x) = \overline{q}_{c_1}(x)$ for $x > 0$ and $f_2(x) \equiv \overline{q}_{c_1}(0)$ for $x < 0$. We find that

$$\overline{q}_{c_1}(x+h) - f_1(x) \in A \quad \text{for} \quad x > -h, \quad h \geq h_0.$$

Choosing as $f_2(x)$ the function $q_{c_2}(x)$, we obtain, by virtue of (5.47),

$$q_{c_2}(x-h) > f(x), \quad x \geq h, \quad h \geq h_0,$$

if h_0 is sufficiently large. Thus we are into the conditions of Lemma 5.6, so that (5.67) holds, or

$$\frac{p(u, t; f)}{u^n} \leq \frac{\overline{\tau}_{c_1}(u)}{u^n}.$$

Changing over to the variables x , we readily find from this that

$$\overline{\varkappa}_n[u(\cdot, t; f) - w_+] \leq \overline{\varkappa}_n[\overline{q}_{c_1} - w_+] = -\lambda_n(c_1),$$

for t sufficiently large. Thus,

$$\overline{\lim}_{t \rightarrow \infty} \overline{\varkappa}_n[u(\cdot, t; f) - w_+] \leq -\lambda_n(c_1).$$

As $c_1 \rightarrow c$, we obtain (5.85).

If $f(x) \equiv w_+$ for $x > x_0$ and $f(x_0) = w_+$, then, similarly, we can use Lemma 5.6. To prove (5.86) we employ Lemma 5.7 in exactly the same way. This completes the proof of the lemma. \square

PROOF OF THEOREM 5.4. We establish approach to a wave in the phase plane. A consequence of this, as shown in §5.1, is approach to a wave in form and speed.

Let $c \in [c_0, c^*)$. Consider the case in which either $f(x) \equiv w_+$ for $x > x_0$ and $f(x_0) > 0$, or $f(x) > w_+$ and

$$\overline{\varkappa}_n[f - w_+] \leq -\lambda_n(c).$$

We obtain an upper estimate to the solution of the Cauchy problem (5.2), (5.3)

in the phase plane. Namely, we prove that for arbitrary small numbers $\varepsilon > 0$ and $\delta > 0$, there exists a number $T = T(\varepsilon, \delta)$, such that

$$(5.87) \quad p(u, t; f) \leq p_c(u) + \varepsilon$$

for $w_+ \leq u \leq w_- - \delta$, $t > T(\varepsilon, \delta)$. We assume that δ is chosen so small that $F(w_- - \delta) > 0$. Through point $(w_- - \delta, p)$ we draw trajectory $\overline{\tau}_{c_1}(u)$, $c_1 > c$, so close to $p_c(u)$ that

$$(5.88) \quad \overline{\tau}_{c_1}(u) \leq p_c(u) + \varepsilon, \quad w_+ \leq u \leq w_- - \delta.$$

This trajectory comes into the points $(w_+, 0)$ and $(w_0, 0)$, where $w_0 \in (w_- - \delta, w_-)$. We choose number t_1 so large that $u_-(t) > w_0$ for $t \geq t_1$. Further, we select number t_2 such that

$$\overline{\tau}_n[u(\cdot, t; f) - w_+] < -\lambda_n(c_1)$$

for $t \geq t_2$. This is possible by virtue of Lemma 5.8. We set $t_0 = \max(t_1, t_2)$ and we take $f_0(x) = u(x, t_0; f)$ as the new initial condition. Applying Proposition 5.8 to functions $f_1(x) = f_0(x)$ and $f_2(x) = \overline{q}_{c_1}(x)$ for $x > 0$, $f_2(x) \equiv \overline{q}_{c_1}(0)$ for $x < 0$, we find that

$$\overline{q}_{c_1}(x + h) - f_0(x) \in A \quad \text{for } x \geq -h$$

for $h \geq h_0$. Further, let $c_2 \in (c, c_1)$. Then, by virtue of the property expressed by inequality (5.47), we obtain

$$q_{c_2}(x - h) > f_0(x) \quad \text{for } x > h \geq h_0,$$

if h_0 is sufficiently large. Thus, the conditions of Lemma 5.6 are satisfied, so that $p(u, t; f) = p(u, t - t_0; f_0) \leq \overline{\tau}_{c_1}(u)$ for $w_+ \leq u \leq w_0$ and $t - t_0 > T(c_1, c_2)$. Relation (5.87) then follows from this and from (5.88). Upper estimates have thus been obtained.

For $c \in (c_0, c^*)$ the estimate

$$(5.89) \quad p(u, t; f) \geq p_c(u) - \varepsilon$$

for $u \in [w_+, w_- - \delta]$, $t > T_1(\varepsilon, \delta)$ is obtained in exactly the same way through use of Lemma 5.7. The estimate (5.89), together with the estimate (5.87), yields convergence of the solution of the Cauchy problem to a wave with nonminimal speed c , $c_0 < c < c^*$. In the case of minimal speed c_0 we have the upper bound (5.87). A lower bound follows from Proposition 5.4 and Theorem 4.11.

To complete the proof of the theorem we need only consider the case $f(x) \equiv w_+$ for $x \geq x_0$, $f(x) > w_+$ for $x < x_0$ and x_0 is a point of continuity of function $f(x)$. We introduce function $f_h(x)$ equal to $f(x)$ for $x \leq x_0 - h$ and equal to zero for $x > x_0 - h$. By virtue of what was proved above, for each $h > 0$ the solution of the Cauchy problem (5.2), (5.3) with initial condition $f_h(x)$ converges in form to a wave. This means that if we denote by $m_h(t)$ the solution of the equation

$$(5.90) \quad u(m_h(t), t; f_h) = (w_+ + w_-)/2,$$

we then have the following equality, uniformly with respect to x on the whole axis:

$$(5.91) \quad \lim_{t \rightarrow \infty} u(x + m_h(t), t; f_h) = w_{c_0}(x).$$

To obtain a similar result for the original function, we note that

$$f_h(x) \leq f(x) \leq f_h(x - h),$$

from which it follows that

$$(5.92) \quad u(x, t; f_h) \leq u(x, t; f) \leq u(x - h, t; f_h).$$

If we denote by $m(t)$ the solution of the equation

$$u(m(t), t; f) = (w_+ + w_-)/2,$$

then from (5.92) and (5.90) we obtain

$$(5.93) \quad m_h(t) \leq m(t) \leq m_h(t) + h.$$

From this inequality, (5.92), and the monotonicity of u with respect to x it follows that

$$(5.94) \quad \begin{aligned} u(x + h + m_h(t), t; f_h) &\leq u(x + m(t), t; f_h) \leq u(x + m(t), t; f) \\ &\leq u(x - h + m(t), t; f_h) \leq u(x - h + m_h(t), t; f_h). \end{aligned}$$

Taking into account the uniform convergence (5.91), and also the convergence $w_{c_0}(x + h) \rightarrow w_{c_0}(x)$ as $h \rightarrow 0$, uniformly with respect to x , we conclude from (5.94) that

$$\lim_{t \rightarrow \infty} u(x + m(t), t; f) = w_c(x),$$

uniformly with respect to x . This completes the proof of the theorem. \square

We proceed to a theorem on approach to a system of waves.

THEOREM 5.5. *Let $f(x)$ be a nonincreasing function, $f(x) \geq w_+$ for $x \in (-\infty, \infty)$, and let $f(-\infty)$ lie in the domain of attraction of point w_- relative to equation (5.35). Let c_0 be the maximal wave speed on the integral $[w_+, w_-]$.*

Then:

1. *If $f(x) \equiv w_+$ on some semi-axis $x \geq x_0$ or $f(x) > w_+$ and*

$$\varkappa_n[f - w_+] \leq -\lambda_n(c_0), \quad n \geq 1,$$

then the solution $u(x, t; f)$ of the Cauchy problem (5.2), (5.3) approaches the minimal system of waves in form and speed.

2. *If $f(x) > w_+$, the exponent $\varkappa_n[f - w_n]$ is strict, and*

$$\varkappa_n[f - w_+] = -\lambda_n(c), \quad n \geq 1,$$

where c is an arbitrary number, $c > c_0$, then the solution $u(x, t; f)$ approaches a c -minimal system of waves in form and speed.

PROOF. Let $w(x; a, b)$ be an arbitrary wave entering the system of waves $R_0(u)$ under consideration, and let $\tau(u; a, b)$ be its representation in the phase plane. We introduce function $f_0(x)$ which coincides with $f(x)$ for $a \leq f(x) \leq b$, is equal to a for $f(x) < a$, and is equal to b for $f(x) > b$. Then, for arbitrary h , $f_0(x + h) - f(x) \in A_0$, from which it follows by Theorem 4.11 that for $t \geq 0$

$$(5.95) \quad p(u, t; f) \leq p(u, t; f_0), \quad a \leq u \leq \min(b, u_-(t)).$$

We note, from an estimate of the derivatives of solutions of equation (3.27), that for an arbitrary given ε only a finite number of waves $\tau(u; a, b)$ entering into the given system of waves can fail to satisfy the condition $\tau(u; a, b) > -\varepsilon$ for $a \leq u \leq b$.

Therefore, it follows from the convergence of $p(u, t; f_0)$ to $\tau(u; a, b)$ and from (5.95) that for arbitrary ε and δ a number $T(\varepsilon, \delta)$ can be found such that for $t > T(\varepsilon, \delta)$

$$p(u, t; f) \leq R_0(u) + \varepsilon, \quad w_+ \leq u \leq w_- - \delta.$$

An estimate from below of function $p(u, t; f)$ for a minimal system of waves follows from Proposition 5.4 and Theorem 4.11.

If we consider a c -minimal system of waves for $c > c_0$, then, as in the proof of the preceding theorem, we introduce functions $q(x)$ and $\bar{q}(x)$, defined for $x \geq 0$, satisfying the inequality $w_+ \leq q$, $\bar{q} \leq w_-$, tending towards w_+ as $x \rightarrow +\infty$, $q(0) = w_-$, $\bar{q}'(0) = 0$,

$$\frac{q'(x)}{(q(x) - w_+)^n} \rightarrow -\lambda_n(c_1), \quad x \rightarrow \infty,$$

while $\bar{q}(x)$ satisfies the same type of relation with c_2 , where $c_0 < c_1 < c_2 < c$ and $c - c_1$ can be arbitrarily small. For sufficiently large t we obtain

$$(5.96) \quad p(u, t; f) \geq \tau(u), \quad w_+ \leq u \leq \bar{q}(0),$$

where the inequality can be strict, choosing, for necessity, the “lower” trajectory from the bundle of trajectories coming into point $(w_+, 0)$ of plane (u, p) . Here function $\tau(u)$ corresponds to $q(x)$ and the indicated trajectory. It follows from the last inequality and the Remarks to Lemma 5.2 that (5.96) is valid for $w_+ \leq u \leq u_-(t)$ for sufficiently large t .

If we define function $q(x)$ for $x < 0$ so that on this semi-axis it is equal to w_- , then as is readily verified, function $p(u, t; q)$ will increase monotonically with respect to t for each u , $w_+ < u < w_-$, and will tend towards function $R_1(u)$ corresponding to a c_1 -minimal system of waves. Since $p(u, t; f) \geq p(u, t - t_0; q)$ for $t \geq t_0$, $w_+ \leq u \leq u_-(t)$ for t_0 sufficiently large, and $R_1(u)$ tends towards $R(u)$ as $c_1 \rightarrow c$, we have the inequality

$$p(u, t; f) \geq R(u) - \varepsilon, \quad w_+ \leq u \leq u_-(t),$$

where $\varepsilon \rightarrow 0$ as $t \rightarrow \infty$. This completes the proof of the theorem. \square

The theorem just proved makes it possible to give a general picture of the asymptotic behavior of solutions of the Cauchy problem (5.2), (5.3) for sources of the second type (monostable case). We assume that the initial function $f(x)$ is nonincreasing, that $f(+\infty) = w_+$, and that $f(-\infty)$ lies in the domain of attraction of point w_- . If $f(x) = w_+$ on some semi-axis, then, as the theorem implies, solutions of the Cauchy problem (5.2), (5.3) as $t \rightarrow \infty$ converge to the minimal system of waves. Consider now the case where $f(x) > w_+$. Since $f(x)$ is a nonincreasing function, then $\varkappa_n[f - w_+] \leq 0$, which follows directly from the definition of the exponent \varkappa (see §5.3). Let $\varkappa_n[f - w_+] < 0$. Then if $\varkappa_n[f - w_+] \leq -\lambda_n(c_0)$, where c_0 is the maximal wave speed in the minimal system of waves, then the solution of problem (5.2), (5.3) converges to a minimal system of waves. But if $\varkappa_n[f - w_+] > -\lambda_n(c_0)$, then, obviously, we can find exactly one number $c > c_0$, such that $\varkappa_n[f - w_+] = -\lambda_n(c)$, and the solution of the Cauchy problem converges to a c -minimal system of waves. Recall that, according to Theorem 3.15, such a system of waves exists for arbitrary $c \geq c_0$.

In this way, we see that under the assumptions made relative to $f(x)$ the asymptotic behavior of solutions of the Cauchy problem (5.2), (5.3), in the case of sources of the second type, may be described by systems of waves. In fact, this

is true even under lesser restrictions on the initial function (see §6). There is an analogous result for sources of the first type, a consequence of Theorem 5.2.

In this section we go into detail on sources of the second type. Sources of the third type, where both points w_+ and w_- are unstable, may be studied in exactly the same way; therefore we limit the discussion to brief remarks only. We note first that there are no waves for such sources (see §3). We can therefore discuss only an approach to a systems of waves. Here we need to require fulfillment of the condition $f(+\infty) = w_+$, $f(-\infty) = w_-$. Along with the exponent \varkappa characterizing the behavior of function $f(x)$ at $+\infty$, it is necessary also to introduce an analogous exponent describing the behavior of $f(x)$ at $-\infty$. One must also define analogous c^\pm -minimal systems of waves. (For such wave systems c^+ is the speed of an (a, \cdot) -wave, c^- is the speed of a (\cdot, b) -wave.) Then, depending on the values of the exponents \varkappa of the functions $f - w_+$ and $w_- - f$ at $+\infty$ and $-\infty$, respectively, we obtain an approach to the corresponding systems of waves.

§6. Supplement (Additions and bibliographic commentaries)

Wave solutions described by scalar parabolic equations

$$(6.1) \quad \frac{\partial u}{\partial t} = \frac{\partial^2 u}{\partial x^2} + F(u)$$

were first considered in papers by Fisher [Fis 1] and by Kolmogorov, Petrovskiy, and Piskunov [Kolm 1] in connection with biological problems concerning propagation of a dominant gene. In [Kolm 1] for a positive source ($F(u) > 0$, for $0 < u < 1$, $F(0) = F(1) = 0$) with the additional condition

$$(6.2) \quad F'(u) \leq F'(0) \quad \text{for} \quad 0 \leq u \leq 1,$$

the existence of waves was proved for all speeds $c \geq c_0$. The minimal speed of a wave in the given case was calculated explicitly and was found equal to $2(F'(0))^{1/2}$. For an initial condition of a particular form

$$(6.3) \quad u(x, 0) = f(x),$$

where $f(x) = 1$ for $x \leq 0$, $f(x) = 0$ for $x > 0$, approach of a solution of the Cauchy problem (6.1), (6.3) to a wave with minimal speed, and in form and speed the absence of a uniform approach was proved. Zel'dovich and Frank-Kamenetsky [Zel 2] showed that equation (6.1) can describe propagation of a wave of combustion of gases (see source in Figure 1.3) and they presented a method of determining approximately the speed of the wave for problems of combustion (narrow reaction zone method). In [Baren 2] stability of a wave to small perturbations was established and the concept of stability with shift (see Chapter 5) was introduced. In [Kan 1, 3] studies were made of the problem of the stability of a wave and of the approach to a wave for sufficiently general initial conditions in the case of a positive source and for a source satisfying the conditions

$$F(u) \leq 0 \quad \text{for} \quad 0 < u < u_0 < 1,$$

$$F(u) > 0 \quad \text{for} \quad u_0 < u < 1, \quad \int_0^1 F(u) du \geq 0.$$

In [II 2, 3] the equation

$$\frac{\partial u}{\partial t} = \frac{\partial^2 u}{\partial x^2} + \frac{\partial \varphi(u)}{\partial x}$$

was considered. Existence of a wave solution was established and also the approach to it, uniformly on the whole axis, from initial conditions of a fairly general form.

Later on, a large number of papers appeared in which wave solutions of scalar parabolic equations were considered. In these papers the studies involved more general sources and initial conditions, multi-dimensional equations, and equations of other types.

The existence of waves was studied in [Aro 1, Fife 7, Kolm 1, Ter 1, Vol 3], and was also considered in the majority of the papers devoted to the study of waves. A minimax representation for the speed was obtained in [Had 2] and was applied to the study of waves (see §2) in [Vol 3]. Conditions under which the minimal speed of a wave is equal to $2(F'(0))^{1/2}$ (without satisfying condition (6.2)) was examined in [Khu 1].

Problems relating to the approach to a wave under various assumptions on the form of the source and initial conditions were studied in papers (besides those indicated above) [Aro 1, Bra 1, Fife 6–8, Kam 1, Lua 1, Lar 2, McK 1, Moe 1, Rot 1, 2, Sto 1, 2, Uch 1, 2, Vol 14–16, 18, 19]. Systems of waves were considered in [Fife 6–8] under certain assumptions on the type of source, and in [Vol 15, 16, 18, 19] for a source of a general form.

Stability of waves was investigated in [Baren 2, Hag 1, Kan 3, Sat 1, 2, Vol 11].

There are a number of papers in which the nonlinear equation

$$\frac{\partial u}{\partial t} = F\left(\frac{\partial^2 u}{\partial x^2}, \frac{\partial u}{\partial x}, u\right)$$

is considered with a condition of parabolicity or various special cases of this equation ([Atk 1, Chu 1, Eng 1, Erm 2, Grin 2, Hag 1, Her 1, Oth 1, Pim 1, Zhi 1]). There also exists a wide literature devoted to the study of equation (6.1) in semi-bounded and bounded domains (see [Aro 1, Dik 1, Vel 1, 2]). In [Gard 6] a study is made of wave solutions of scalar equations of higher order.

In §§1–5 a fairly detailed presentation is given of the theory of waves described by a scalar parabolic equation. We decided, however, to carry over certain problems to this supplement in order not to complicate the exposition. Included among these problems are, in particular, the uniform approach to a wave, nonmonotone initial conditions, threshold effects, and multi-dimensional equations. All the papers mentioned above are close in their methods and results to what we have presented in the preceding sections of this chapter or to what follows later in this section.

We shall dwell briefly on some other questions. There is, first of all, the problem of the explicit construction of wave solutions for various specific forms of the source $F(u)$. Methods for the construction of exact solutions of semi-linear parabolic equations are presented in the book by Maslov, Danilov, and Volosov [Mas 1], in which, in particular, waves are also considered (see also [Sle 1]).

Another topic, which we shall not touch upon here, is the study of equations with small parameter in the coefficients, the asymptotics of which can lead, for example, to solutions of the equations considered in the present monograph. In particular, this leads to the possibility of studying nonhomogeneous media. Approaches in this direction are developed in the aforementioned book [Mas 1] and

also in [Dan 1, Pap 1] and [Fife 15]. In [Volos 1] a general quasilinear equation with a small parameter is considered and localized waves described by it are studied.

And, finally, one last item. As we have already noted, waves and systems of waves arise naturally as a result of the asymptotics, as $t \rightarrow \infty$, in solutions of the Cauchy problem. There is, however, a range of problems, having important applications, connected with solutions of quasilinear parabolic equations growing without bound after a finite time, so called blow-up solutions (see [Beb 1, Berg 1, Gig 1, Sam 1] and references therein).

6.1. More general initial conditions. We consider first the monostable case, assuming, for definiteness, that $u = 0$ is an unstable point with respect to the equation

$$(6.4) \quad \frac{du}{dt} = F(u),$$

i.e., $F(u) > 0$ in some right half-neighborhood of the origin. In §5 it was shown that approach to a wave and to a system of waves is determined in this case by the behavior of the initial function $f(x)$ as $x \rightarrow \infty$. In particular, if

$$(6.5) \quad F'(0) > 0,$$

then the behavior of solutions of the Cauchy problem at large times depends on the quantity

$$(6.6) \quad \varkappa[f] = \lim_{x \rightarrow +\infty} \frac{f'(x)}{f(x)}.$$

Omitting the details, we can say that a solution approaches wave w_c if

$$(6.7) \quad \varkappa[f] = \varkappa[w_c],$$

for a wave with nonminimal speed, and

$$(6.8) \quad \varkappa[f] \leq \lim_{c \searrow c_0} \varkappa[w_c],$$

for a wave with minimal speed (in fact, a somewhat broader class of functions is considered; see Theorem 5.4). In a similar way, we define approach to systems of waves, except that, in this case, in the conditions (6.7), (6.8), as w_c we mean a wave, entering into a system of waves, for which $w_c(+\infty) = 0$.

We consider functions $f(x)$ having a strict Lyapunov exponent:

$$(6.9) \quad \varkappa_1[f] = \lim_{x \rightarrow +\infty} \frac{\ln f(x)}{x}.$$

As was shown in §5.3, if the limit (6.6) exists, then the limit (6.9) also exists, and they are equal to one another. Thus we have a class of functions broader than the class considered above. It turns out to be the case that for a source of the second type the conditions (6.7), (6.8) for the approach to waves and minimal c -systems of waves remain valid for this class of functions when the inequality (6.5) is satisfied [Vol 16, 19] (we need to substitute $\varkappa_1[f]$ for $\varkappa[f]$ in (6.7), (6.8)). Here, as earlier, we consider monotone initial conditions for which $f(-\infty)$ belongs to the domain of attraction of point $u = 1$ with respect to equation (6.4). For a positive

source we can waive the monotonicity conditions. We require, moreover, that the inequality

$$\underline{\lim}_{x \rightarrow -\infty} f(x) > 0$$

be satisfied (although this condition can be weakened).

Assume now that the following limit exists for some $h > 0$:

$$\varkappa_2[f] = \lim_{x \rightarrow +\infty} \frac{1}{x} \ln \int_x^{x(1+h)} f(\xi) d\xi.$$

This involves an even broader class of functions, and, for a positive source, it has been shown, with fulfillment of the additional condition (6.2), that even in this case we have approach to a wave in form and speed [**Bra 1, Lua 1**]. As before, the conditions (6.7), (6.8) (with \varkappa replaced by \varkappa_2) determine which wave the solutions of the Cauchy problem approach.

For sources of the third type, if

$$F'(0) > 0, \quad F'(1) > 0,$$

the approach of solutions of the Cauchy problem to systems of waves is also determined by Lyapunov exponents of function $f(x)$ at $+\infty$ and of function $(1 - f(x))$ at $-\infty$ [**Vol 16**].

All the results concerning approach to waves and systems of waves are set forth in §5 for monotone conditions. In a number of cases this restriction can be waived. For a positive source, nonmonotone initial conditions were considered in [**Kan 1, Kam 1, Moe 1, Rot 1, Uch 2, Vol 14, 2**]. In [**Fife 7**], for the bistable case, with fulfillment of the additional conditions

$$F'(0) < 0, \quad F'(1) < 0,$$

monotonicity is also not required. Moreover, if

$$(6.10) \quad \begin{aligned} F(u) < 0 & \quad \text{for} \quad 0 < u < a_0, \\ F(u) > 0 & \quad \text{for} \quad a_1 < u < 1, \end{aligned}$$

where $0 < a_0 \leq a_1 < 1$, and if a $[0, 1]$ -wave exists, then the solution approaches it uniformly if $0 \leq f(x) \leq 1$ for all x and

$$(6.11) \quad \overline{\lim}_{x \rightarrow +\infty} f(x) < a_0, \quad \underline{\lim}_{x \rightarrow -\infty} f(x) > a_1.$$

It follows from this, in particular, that under the assumptions stated (without conditions (6.11)) the solution $u(x, t; f)$ of the Cauchy problem approaches a wave as $t \rightarrow \infty$ iff the following conditions are satisfied:

$$\overline{\lim}_{x \rightarrow +\infty} u(x, t; f) \rightarrow 0, \quad \underline{\lim}_{x \rightarrow -\infty} u(x, t; f) \rightarrow 1.$$

At the end of this section we present, without proof, two theorems concerning approach to a wave in the case of nonmonotone initial conditions. We consider first the monostable case, assuming that $u = 0$ is an unstable point with respect to equation (6.4) and $F(u)/u^n \rightarrow a_n$, where $n \geq 1$, $a_n > 0$. We shall assume that there

exist $[0, 1]$ -waves with speeds $c \in [c_0, c_1)$. Then $F(u) > 0$ for $a_1 < u < 1$ for some $a_1, 0 < a_1 < 1$. For simplicity, we limit the discussion to smooth initial functions.

THEOREM 6.1. *Let $0 \leq f(x) \leq 1$ for all x and $\liminf_{x \rightarrow -\infty} f(x) > a_1$. If*

$$\lim_{x \rightarrow \infty} \frac{f'(x)}{f^n(x)} = -\frac{a_n}{c/2 + (c^2/4 - \alpha)^{1/2}}$$

for $c \in (c_0, c_1)$, then solution $u(x, t; f)$ of the Cauchy problem (6.1), (6.3) approaches the wave $w_c(x)$ in form and speed. If

$$\overline{\lim}_{x \rightarrow \infty} \frac{f'(x)}{f^n(x)} \leq -\frac{a_n}{c_0/2 + (c_0^2/4 - \alpha)^{1/2}},$$

then the solution approaches wave w_{c_0} with minimal speed. (Here $\alpha = F'(0)$.)

The proof of this theorem repeats, almost literally, the proof of the corresponding assertions of Theorem 5.4. The difference is that, instead of functions $q(x)$ defined for $x \geq 0$ and satisfying conditions

$$(6.12) \quad \begin{aligned} q'(0) = 0, \quad q'(x) < 0 \quad \text{for } x > 0, \quad 0 < q(x) < 1 \quad \text{for } x \geq 0, \\ \lim_{x \rightarrow \infty} \frac{q'(x)}{q^n(x)} = -\frac{a_n}{c/2 + (c^2/4 - \alpha)^{1/2}}, \end{aligned}$$

we consider an arbitrary smooth monotonically decreasing function $g(x)$, given on the whole axis, for which

$$a_1 < g(-\infty) < \liminf_{x \rightarrow -\infty} f(x)$$

and limit (6.12) exists. Here we need to account for the fact that, in view of the result of §5, the solution $u(x, t; g)$ approaches a wave in form and in speed.

THEOREM 6.2. *Let us assume the following: conditions (6.10) are satisfied, a $[0, 1]$ -wave $w(x)$ exists, $f(x)$ is a piecewise-continuous function with a finite number of points of discontinuity, $0 \leq f(x) \leq 1$ for all x , and the following limits exist:*

$$(6.13) \quad \lim_{x \rightarrow +\infty} f(x) = 0, \quad \lim_{x \rightarrow -\infty} f(x) = 1.$$

Then the solution of the Cauchy problem (6.1), (6.3) approaches the wave $w(x)$ in form and in speed.

In proving this theorem we first show that the solution becomes monotone for $\varepsilon(t) \leq u \leq 1 - \varepsilon(t)$, where $\varepsilon(t) \rightarrow 0$ as $t \rightarrow \infty$. After this, we follow the same procedures as in the proof of Theorem 5.1.

We note, in comparison with the results presented above from [Fife 7], that here we allow the derivatives $F'(0)$ and $F'(1)$ to be zero; there is, however, the additional condition (6.13).

6.2. Nonmonotone systems of waves. Up until now we have considered systems of waves consisting of decreasing waves. Along with this, there exist systems of waves in which decreasing as well as increasing waves appear. Such systems of waves can also describe the behavior of solutions of the Cauchy problem for large times.

The most detailed studies of nonmonotone systems for a positive source appear in [Vol 14] and [Uch 2]. In the given case the system of waves consists of two

waves, moving in opposite directions, each with its own speed. If $F'(0) > 0$ and $f(x) \rightarrow 0$ as $x \rightarrow \pm\infty$ ($0 \leq f(x) \leq 1$, $f(x) \not\equiv 0$), then the solution of the Cauchy problem approaches a system of waves of this kind. The waves of the system in question are determined by Lyapunov exponents of the initial condition as $x \rightarrow +\infty$ and as $x \rightarrow -\infty$ [Vol 14].

Results are also available concerning approach to nonmonotone systems of waves for sources with alternating signs [Fife 7, Rot 1].

6.3. Uniform approach to a wave. In §5 uniform approach to a wave and approach in form and speed were defined; however, in all the theorems concerning approach to waves and systems of waves, only the second case was considered. This is connected with the fact that uniform approach to a wave will be discussed in Chapter 5 for monotone systems, a particular case of which is the scalar equation. There we shall consider the stability of waves to small perturbations (with shift, without shift, with weight). However, uniform approach to a wave for a scalar equation is studied in more detail, certain problems relating to which we pause to consider here briefly.

A solution can approach uniformly not only a wave [Kan 1, Fife 7, Moe 1, Rot 1, Rot 2], but also a system of waves [Fife 7], including also the case of nonmonotone initial conditions (monotone solutions are considered in Chapter 5). For a scalar equation, studies have been made, in the monostable case, of uniform approach to a wave with nonminimal speeds $c > c_0$, and to a wave with minimal speed c_0 in the case $c_0 = c_*$ ($c_* = 2(F'(0))^{1/2}$) [Moe 1, Uch 2], which so far has not been done for systems of equations.

We recall that for $c > c_*$

$$(6.14) \quad w_0(x)e^{\lambda x} \rightarrow a, \quad x \rightarrow +\infty,$$

and, for uniform approach to a wave in the case of a positive source, we require that the initial function has analogous behavior also [Uch 2]:

$$f(x)e^{\lambda x} \rightarrow a_1, \quad x \rightarrow \infty.$$

Here a, a_1 are positive constants, $\lambda = c/2 - (c^2/4 - \alpha)^{1/2}$ for $c > c_0$, and $\lambda > c_0/2 - (c_0^2/4 - \alpha)^{1/2}$ for $c = c_0$.

For $c = c_*$ we can have either (6.14) or

$$w_0(x)\frac{1}{x}e^{\lambda x} \rightarrow a_2, \quad x \rightarrow +\infty.$$

In this case, for uniform approach to a wave, the initial function must behave in the same way [Uch 2].

Without the restrictions indicated, there can be no uniform approach. We have already referred to the result, given in [Kolm 1], concerning the fact that for the initial condition $f(x) = 1$ for $x \leq 0$ and $f(x) = 0$ for $x > 0$ there can be approach to a wave in form and in speed, but with the uniform approach lacking.

6.4. Threshold effect. For a positive source, in the case $F'(0) > 0$, and for an arbitrary initial condition $f(x)$ not identically equal to zero, solution $u(x, t; f)$ of the Cauchy problem tends towards 1 as $t \rightarrow \infty$ on each finite interval. Here approach to a wave or to a system of waves is possible. However, if $F'(0) = 0$, this is possible only for initial conditions sufficiently large in some sense; in the contrary case the solution can tend towards 0. This is referred to as the threshold effect. A

precise result for the multi-dimensional case may be formulated as follows [**Aro 2**] (see also [**Kalan 1, Uch 2**]):

If

$$\lim_{u \rightarrow 0} u^{-(1+2/n)} F(u) > 0,$$

then all perturbations increase;

if

$$F(u) \leqslant ku^\beta, \quad \beta > 1 + 2/n,$$

then there are decaying perturbations. Here n is the dimension of the space.

The threshold effect was also studied for sources with alternating signs [**Aro 1, Hag 1**].

6.5. Methods of analysis. Existence and properties of waves and systems of waves are studied mainly on the basis of an analysis of the behavior of trajectories of the first order systems of equations

$$w' = p, \quad p' = -cp - F(w).$$

The method of functionals (see §§2, 3), connected with a minimax representation of the speed, was studied in [**Vol 3**] and [**Had 2**]. Methods for proving the existence of waves in the multi-dimensional case for systems of equations are discussed in §6.6 and in Chapter 3.

We can, apparently, identify four basic methods for investigating the approach of solutions of the Cauchy problem to waves and systems of waves.

The first method is based on application of comparison theorems on the phase plane. It was first used in [**Kolm 1**]. Subsequently, it evolved and was applied in a large number of papers (see, for example, [**Vol 14, Fife 8, Uch 2**]), making it possible to obtain rather general results. This approach is described in detail in §4 and all the results in §5 are obtained in precisely this way.

A second method, presented in [**Fife 7**], is based on the construction of a functional decreasing on solutions. We describe the essence of this method briefly, omitting various details.

If $u(x, t)$ is a solution of the equation

$$(6.15) \quad \frac{\partial u}{\partial t} = \frac{\partial^2 u}{\partial x^2} + c \frac{\partial u}{\partial x} + F(u),$$

then the functional

$$V(u) = \int_{-\infty}^{\infty} e^{cx} \left[\frac{1}{2} \left(\frac{\partial u}{\partial x} \right)^2 - \Phi(u) \right] dx,$$

where

$$\Phi(u) = \int_0^u F(\tau) d\tau$$

decreases along the solution. Indeed,

$$\frac{dV}{dt} = \int_{-\infty}^{\infty} e^{cx} \left[\frac{\partial u}{\partial x} \frac{\partial^2 u}{\partial x \partial t} - F(u) \frac{\partial u}{\partial t} \right] dx = - \int_{-\infty}^{\infty} \left(\frac{\partial u}{\partial t} \right)^2 dx.$$

(It is necessary here to concern ourselves with convergence of the integrals and to show, after an integration by parts, that the integrated terms are equal to 0.) If we

show that $V(u)$ is bounded from below, then, as $t \rightarrow \infty$, the solution $u(x, t)$ will tend towards the stationary solution of equation (6.15), i.e., to a wave.

The method for establishing approach of solutions to a wave with application of the Lyapunov functional was also used in [Rot 1] and [Uch 2].

Our next method for investigating the asymptotic behavior of solutions at large times is connected with an analysis of the stability of a wave to small perturbations. It will be considered in detail in Chapter 5. We merely note here that stability of a wave is determined by the location of the spectrum of the linearized equation. The problem here is made complex due to the presence of a continuous spectrum, points of which can be in the right half-plane, and a zero eigenvalue. For the scalar equation, as was already pointed out above, stability of waves to small perturbations was studied in [Baren 2, Vol 11, Sat 1, 2].

And, finally, there are papers in which waves are investigated by probabilistic methods [Bra 1, McK 1]. Some of the results obtained in these works were obtained somewhat simpler using other methods (compare [Bra 1] and [Lua 1]).

We note that a principal peculiarity of the scalar equation (in contrast to systems of equations) is the applicability to it of positiveness theorems in the linear case and of comparison theorems in the nonlinear case (see §4). These are theorems which, in one form or another, are used in the study of waves. In particular, they make it possible to establish in an elementary way stability (not asymptotic stability) of a monotone wave to small perturbations. Indeed, if $w(x)$ is a stationary solution of equation (6.15), and the initial function $f(x)$ satisfies the inequalities

$$w(x+h) \leq f(x) \leq w(x-h), \quad -\infty < x < +\infty,$$

then analogous inequalities hold also for a solution of the Cauchy problem. Instability of nonmonotone waves is also simply established (see Theorem 5.3 and [Hag 1]).

In conclusion, we give yet another simple method for proving the approach of solutions to a wave for a positive source when condition (6.2) is satisfied. We note that the difference of two solutions u_1 and u_2 of equation (6.1), in absolute value, is majorized by a solution v of the problem

$$\frac{\partial v}{\partial t} = \frac{\partial^2 v}{\partial x^2} + \alpha v, \quad v(x, 0) = |u_1(x, 0) - u_2(x, 0)|$$

($\alpha = F'(0)$). Introducing a new function

$$z(\xi, t) = e^{-\frac{\alpha}{2}\xi} v(\xi, t), \quad \xi = x + ct,$$

we obtain

$$\frac{\partial z}{\partial t} = \frac{\partial^2 z}{\partial x^2} + \left(\frac{c^2}{4} - \alpha \right) z, \quad z(\xi, 0) = e^{-\frac{\alpha}{2}\xi} v(\xi, 0).$$

Taking into account the positiveness of the coefficient of z ($c^2/4 \geq \alpha$), and the estimate

$$|\varphi(x, t)| \leq \frac{1}{(4\pi t)^{1/2p}} \|\varphi(x, 0)\|_{L^p}$$

of the solution of the equation

$$\frac{\partial \varphi}{\partial t} = \frac{\partial^2 \varphi}{\partial x^2}$$

for all x and $t > 0$, we obtain, for arbitrary h ,

$$(6.16) \quad \begin{aligned} & |u(x + ct, t; f) - w_0(x + h)|e^{-\frac{c}{2}\xi} \\ & \leq \frac{e^{-(\frac{c^2}{4} - \alpha)t}}{(4\pi t)^{1/2p}} \left(\int_{-\infty}^{\infty} e^{-p\frac{c}{2}\xi} |f(\xi) - w_0(\xi + h)|^p d\xi \right)^{1/p}. \end{aligned}$$

The uniform approach to a wave on an arbitrary right semi-axis as $t \rightarrow \infty$ follows from this.

Estimates of this kind were obtained in [Moe 1].

We remark that inequality (6.16), as well as the methods based on use of the Lyapunov functional and stability analysis, makes it possible to estimate the rate of convergence of a solution to a wave. It is interesting to observe that if for $c^2/4 > \alpha$ the convergence is exponential, then for $c^2/4 = \alpha$ it is of power-law type.

6.6. Multi-dimensional equation. The multi-dimensional scalar equation has been studied in less detail than the one-dimensional equation. In [Aro 2] a study is made of the rate of propagation of perturbations, and in [Jon 1, 2] approach to a one-dimensional wave is proved on one-dimensional sections of space \mathbb{R}^n . Stability of waves with respect to small perturbation as well as global stability are studied in [Beres 6, Roq 1–3, Lev 1, Xin 1, 2].

Recently, a large number of papers have appeared in which existence of multi-dimensional waves is established in cylindrical domains. In [Beres 1–3, 5, 7] equations of the form

$$\Delta u - c\alpha(y) \frac{\partial u}{\partial x_1} + f(y, u) = 0$$

and

$$\Delta u - (c + \alpha(y)) \frac{\partial u}{\partial x_1} + f(y, u) = 0$$

are considered, where x_1 is a variable along the cylinder axis, and $y = (x_2, \dots, x_n)$ is a variable in a cylinder cross-section, with boundary conditions

$$\frac{\partial u}{\partial \nu} \Big|_{x \in S} = 0, \quad u \Big|_{x_1 = \pm \infty} = u_{\pm}.$$

Here S is the surface of the cylinder, $\partial u / \partial \nu$ is a normal derivative, u_{\pm} are constants, $\alpha(y)$ and $f(y, u)$ are given functions, and c is the wave speed.

In these papers, to prove existence of waves, the existence of solutions is first proved in bounded domains using the theory of rotation of vector fields; this is followed by a passage to the limit. We remark that a similar approach is applied in [Beres 4, Bon 1, Hei 1] for systems of equations in the one-dimensional case (see Chapter 3). In both cases boundedness of the domain makes it possible to deal with completely continuous vector fields, i.e., to make use of the classical theory. However, to justify passage to the limit in this approach it is necessary to use the specific character of the nonlinear source. Construction of a rotation of vector fields for operators acting in the space of functions given on the whole axis is carried out in Chapter 2. Remarks relating to the multi-dimensional case also appear in Chapter 2.

In [**Gard 3**] a proof is given for existence of wave solutions for the equation

$$(6.17) \quad \frac{\partial u}{\partial t} = \Delta u + f(u),$$

considered in the strip $x \in \mathbb{R}^1$, $0 \leq y \leq L$, with boundary conditions

$$u|_{y=0, y=L} = 0, \quad u|_{x=-\infty} = u_0, \quad u|_{x=+\infty} = u_1(y),$$

where u_0 is a constant and $u_1(y)$ is a solution of the problem

$$\frac{d^2 u}{dy^2} + f(u) = 0, \quad u(0) = u(L) = 0.$$

The method of proof is based on reducing equation (6.17) to a difference equation with respect to variable y :

$$(6.18) \quad \frac{\partial u_i}{\partial t} = \frac{\partial^2 u_i}{\partial x^2} + \frac{u_{i+1} - 2u_i + u_{i-1}}{h^2} + f(u_i).$$

In fact, this is a system of equations in the one-dimensional functions $u_1(x), \dots, u_n(x)$. Existence of waves for this system is proved by the method of isolated invariant sets [**Con 1**] (see Chapter 3); this is followed by a passage to the limit with $h \rightarrow 0$.

We note that the system of equations (6.18) is monotone in the sense of a definition given in Chapter 3 and results concerning existence of waves, obtained in that chapter, are therefore applicable to it.

Equation (6.17) in the n -dimensional case is considered in [**Hei 2**]. To prove existence of waves the functional

$$V(u) = \int_D e^{cx} \left[\frac{1}{2} |\nabla u|^2 - \Phi(u) \right] dx dy, \quad \Phi(u) = \int_0^u f(\xi) d\xi,$$

decreasing along solutions, is employed (compare with the functional $V(u)$ in §6.5).

In [**Uch 3**] asymptotic behavior of solutions of equations with variable coefficients is studied. These equations arise, in particular, in studies of spherically symmetric multi-dimensional equations.

Papers have also appeared [**Ami 1**, **Kir 1**] in which the existence of waves in the multi-dimensional case is established by the method of bifurcations.

Estimates of solutions of parabolic equations in a cylindrical domain with the aid of sub- and super-solutions of traveling wave type are derived in [**Bel 4**]. Studies devoted to various other problems connected with multi-dimensional waves appear in [**Ger 1, 2**, **Fre 1**].

Asymptotic methods have been developed for the problems in question in [**Barles 1**, **Bron 1, 2**, **Fre 2, 3**, **Hil 2**, **Mot 1–6**, **Scha 1**].

Leray-Schauder Degree

§1. Introduction. Formulation of results

The study of scalar parabolic equations, in a number of cases, can be made, as is evident from the preceding chapter, using a rather simple mathematical technique. In the transition to systems of equations this technique turns out to be, as a rule, insufficient and other methods of investigation must be chosen. What seems promising, from this point of view, is the introduction of operators describing wave solutions of parabolic systems of equations and the application to them of results obtained for specific classes of nonlinear operators. In this chapter we attempt to realize this approach. The operators in question will be defined here and estimates will be obtained for them, making it possible to establish the Fredholm property of the operators and to construct a rotation of the vector field (Leray-Schauder degree). Rotation of the vector field, in turn, allows us to apply the Leray-Schauder method to prove the existence of waves, to study nonlocal bifurcations, etc. In Chapter 3 we apply the Leray-Schauder method to a class of parabolic systems for which the obtaining of a priori estimates of solutions becomes possible. The results presented in this chapter were obtained in [Vol 5, 6, 8, 42].

We consider the parabolic system of equations

$$(1.1) \quad \frac{\partial u}{\partial t} = a \frac{\partial^2 u}{\partial x^2} + F(u),$$

where a is a positive definite symmetric square matrix of order n , and $F(u)$ is a vector-valued function, defined and continuously differentiable for $u \in \mathbb{R}^n$. A solution of system (1.1) is called a solution of traveling wave type if

$$(1.2) \quad u(x, t) = w(x - ct),$$

where $w(x)$ is a twice continuously differentiable vector-valued function, bounded for all real x , and c is a constant, the speed of the wave. If we substitute (1.2) into (1.1), we obtain the system of equations

$$(1.3) \quad aw'' + cw' + F(w) = 0,$$

in which the unknowns are the function w and the constant c . We limit the discussion to traveling waves $w(x)$ having limits as $x \rightarrow \pm\infty$:

$$(1.4) \quad \lim_{x \rightarrow \pm\infty} w(x) = w_{\pm},$$

where $w_+ \neq w_-$ and

$$(1.5) \quad F(w_+) = F(w_-) = 0.$$

Thus, the study of wave solutions leads to a problem over the whole axis, and this proves to be essential from the point of view of defining rotation of the vector field.

It is well known (see [Lad 1], for example) that if equation (1.3) is considered in a bounded domain, then the corresponding vector field can be reduced to a completely continuous one. Indeed, let us denote by A the operator corresponding to the left-hand side of (1.3) and acting in the space C^α with domain of definition $C^{2+\alpha}$. By virtue of the compactness of the embedding of $C^{2+\alpha}$ in C^α , it can be written in the form

$$A = L + B = L(I + L^{-1}B),$$

where L has a completely continuous inverse, and from equation $Lu = 0$ it follows that $u = 0$, and B is a bounded operator. Thus, we can consider the completely continuous vector field $I + L^{-1}B$ and use the degree in its classical version [Ler 1]. If the domain considered is unbounded, the embedding of $C^{2+\alpha}$ in C^α is not a compact operator, and this approach cannot be used.

Nevertheless, in some cases the vector field can be reduced to a compact one in the case of unbounded domains. In [Esc 1] weighted Sobolev spaces are considered with a strong weight, for example, $\exp(x^2)$. The representation of operator A , presented above, can also be obtained in this case. Of essence here is the fact that the weight functions should grow faster than exponentially. This means that functions of exponential decay do not belong to these spaces, and this is a strong limitation on application of this approach. In particular, it cannot be used for the study of wave solutions to parabolic systems of equations of type (1.1).

In constructing a rotation of the vector field we shall follow the method of I. V. Skrypnik [Skr 1]. Estimates of operators play an essential role here; obtaining these estimates determines the possibility of applying the method indicated. Also of importance here is the choice of functional spaces. For example, for space C it is easy to construct, using results of the preceding chapter, an example of homotopic operators, for one of which a wave exists and for another it does not, though, a priori estimates are preserved during homotopy. This means that the degree with usual properties, including homotopy invariance, cannot be introduced for an arbitrary space.

We note that, along with this approach, which we apply here, other approaches to the construction of a rotation of the vector field and to the application of the Leray-Schauder method are possible. More detail concerning this is given in the supplement to Chapter 3.

We now state a condition on system (1.1) under which our investigations will be carried out.

We introduce the notation

$$b_+ = F'(w_+), \quad b_- = F'(w_-),$$

where $F'(u)$ is the matrix of first partial derivatives. In proceeding, we assume the following condition is satisfied:

CONDITION 1.1. *The eigenvalues of the matrices $b_\pm - \alpha\xi^2$ lie in the left half-plane for all real ξ .*

We note that this condition is connected with the location of the continuous spectrum of an operator (see Chapter 4). We show now how to make the transition

from problem (1.3), (1.4) to the corresponding operator. For this purpose, it is convenient to introduce the boundary conditions (1.4) into the coefficients of equation (1.3), so that the unknown function vanishes at the infinities. With this in mind, we set

$$(1.6) \quad \begin{aligned} w(x) &= u(x) + \psi(x), \\ \psi(x) &= w_- \omega(x) + w_+ (1 - \omega(x)), \end{aligned}$$

where $\omega(x)$ is a monotone smooth function, equal to zero for $x \geq 1$ and equal to one for $x \leq -1$. Then $u(x)$ satisfies the system

$$(1.7) \quad a(u'' + \psi'') + c(u' + \psi') + F(u + \psi) = 0.$$

We note that, along with $w(x)$ as a solution of system (1.3), we also have the function $w(x + h)$, where h is an arbitrary number. Therefore, to each solution $u(x)$ of equation (1.7) there corresponds a one-parameter family of solutions

$$(1.8) \quad u_h(x) = u(x + h) + \psi(x + h) - \psi(x).$$

The nonisolatedness of the solutions complicates further investigations. Another complication is the fact that, along with the unknown function u , the constant c is also unknown. We can rid ourselves of these two complications through the method of functionalization of a parameter (see [Kra 2]), which, in the case under consideration, may be realized in the following way. Instead of equation (1.7) we consider the equation

$$(1.9) \quad a(u'' + \psi'') + c(u)(u' + \psi') + F(u + \psi) = 0,$$

where $c(u)$ is a functional. Processing, we assume that $u(x)$ is an element of some functional space E (see below). We need to construct functional $c(u)$ so that it is defined on the whole space E and satisfies the following conditions:

1. For each $u \in E$, the function $c(u_h)$, where u_h is defined by equation (1.8), is monotone in h ;
2. $c(u_h) \rightarrow \pm\infty$ as $h \rightarrow \mp\infty$.

We note that, in contrast to constant c in equation (1.7), the functional $c(u)$ in equation (1.9) is assumed to be given and only function u is unknown.

When conditions 1 and 2 are satisfied, equation (1.9) is equivalent to equation (1.7) in the following sense. Let constant $c = c_0$ and family $u_h(x)$ ($-\infty < h < +\infty$) constitute a solution of equation (1.7). We select $h = h_0$ from the condition $c(u_{h_0}) = c_0$. By virtue of conditions 1 and 2, such an h exists for arbitrary c_0 and may be determined uniquely. It is obvious that the function $u(x) = u_{h_0}(x)$ is a solution of equation (1.9). Conversely, let $u(x)$ be a solution of equation (1.9). Then the constant $c = c(u)$ and the family $u_h(x)$, defined by equation (1.8), constitute a solution of equation (1.7).

In what follows we introduce space E and construct the functional $c(u)$, satisfying conditions 1 and 2. We consider operator $A(u)$, acting from space E into the conjugate space E^* , defined by the left-hand side of equation (1.9).

For convenience, we give some results from [Skr 1], necessary for the sequel. Let D be a bounded domain in a real separable reflexive Banach space E with

boundary Γ . We assume that operator $A: \Gamma \rightarrow E^*$ is demi-continuous (for the sequel it is sufficient to consider $A(u)$ continuous), bounded,

$$A(u) \neq 0 \quad \text{for} \quad u \in \Gamma,$$

and satisfies the condition

α) for an arbitrary sequence $u_n \in \Gamma$, weakly converging to u_0 , the relation

$$\lim_{n \rightarrow \infty} \langle A(u_n), u_n - u_0 \rangle \leq 0$$

implies the strong convergence of u_n to u_0 .

Here $\langle f, y \rangle$ indicates the action of functional $f \in E^*$ on an element $y \in E$.

Under the assumptions indicated in [Skf 1] a rotation of field $A(u)$ is determined on Γ with the aid of corresponding finite-dimensional fields. It possesses the properties known for the degree for completely continuous vector fields. In particular, rotations of homotopic fields are the same. We introduce the definition of homotopic fields given in [Skf 1]. Let $A_1, A_2: \Gamma \rightarrow E^*$ be bounded demi-continuous operators satisfying condition α), and assume that the fields $A_1(u)$ and $A_2(u)$ do not vanish on Γ . Fields $A_1(u)$ and $A_2(u)$ are said to be homotopic on Γ if there exists a bounded operator $A: \Gamma \times [0, 1] \rightarrow E^*$ such that $A(u, t)$ satisfies condition α'), is demi-continuous, does not vanish on $\Gamma \times [0, 1]$, and, for $u \in \Gamma$:

$$A(u, 0) = A_1(u), \quad A(u, 1) = A_2(u).$$

Condition α') is formulated as follows: for an arbitrary convergent sequence $t_n, t_n \in [0, 1]$, and for an arbitrary sequence $u_n, u_n \in \Gamma$, converging weakly to u_0 , the inequality

$$\lim_{n \rightarrow \infty} \langle A(u_n, t_n), u_n - u_0 \rangle \leq 0$$

implies the strong convergence of u_n to u_0 .

In what follows we formulate the main results of this chapter.

We begin by introducing the functional space E . As space E we take a weighted Sobolev space ${}^*W_{2,\mu}^1$ of vector-valued functions, given on the real axis, with the inner product *

$$(1.10) \quad [u, v]_\mu = \int_{-\infty}^{\infty} \{(u'(x), v'(x)) + (u(x), v(x))\} \mu(x) dx,$$

where $u, v: \mathbb{R}^1 \rightarrow \mathbb{R}^n$. We denote the norm in this space by $\|\cdot\|_\mu$.

We assume the following restrictions on the weight function $\mu(x)$:

1. $\mu(x) \geq 1$, $\mu(x) \rightarrow +\infty$ as $|x| \rightarrow \infty$;
2. $\mu(x)$ has derivatives to the second order and the functions $\mu'(x)/\mu(x)$, $\mu''(x)/\mu(x)$ are bounded and square integrable. It follows from this that $\mu(x) \leq \mu(0) \exp(k|x|^{1/2})$, where k is the norm of μ'/μ in L^2 .

We show now how a functional $c(u)$ possessing the properties indicated above can be constructed in this space. Let $\sigma(x)$ be a monotonically increasing function such that $\sigma(x) \rightarrow 0$ as $x \rightarrow -\infty$, $\sigma(x) \rightarrow 1$ as $x \rightarrow +\infty$,

$$\int_{-\infty}^0 \sigma(x) dx < \infty.$$

We set

$$(1.11) \quad \rho(u) = \left(\int_{-\infty}^{\infty} |u(x) + \psi(x) - w_+|^2 \sigma(x) dx \right)^{1/2},$$

where $\psi(x)$ is defined by equation (1.7), and

$$(1.12) \quad c(u) = \ln \rho(u).$$

PROPOSITION 1.1. *The functional $c(u)$ defined on space E by equations (1.11) and (1.12) satisfies a Lipschitz condition on each bounded set of space E and possesses the following properties: $c(u_h)$ is a monotonically decreasing function of h , $c(u_h) \rightarrow +\infty$ as $h \rightarrow -\infty$, and $c(u_h) \rightarrow -\infty$ as $h \rightarrow +\infty$. Here u_h is defined by equation (1.8), $u \in E$.*

We proceed now to the construction of the operator $A(u)$ mentioned above. For arbitrary $u \in E$, operator $A(u)$, acting from E into E^* , is defined by the equality

$$(1.13) \quad \begin{aligned} \langle A(u), v \rangle &= \int_{-\infty}^{\infty} (au', (v\mu)') dx \\ &\quad - \int_{-\infty}^{\infty} (a\psi'' + c(u)(u' + \psi') + F(u + \psi), v)\mu(x) dx, \end{aligned}$$

where $v \in E$. Recall that $\langle A(u), v \rangle$ denotes the action of functional $A(u) \in E^*$ on element $v \in E$. Note also that for twice continuously differentiable functions u and functions $v \in E$ with a finite support, equation (1.13) has the form

$$\langle A(u), v \rangle = - \int_{-\infty}^{\infty} (a(u'' + \psi'') + c(u)(u' + \psi') + F(u + \psi), v)\mu(x) dx.$$

From this the relationship of operator $A(u)$ to the left-hand side of equation (1.9) is evident. It is easy to see that each solution $u \in E$ of equation

$$(1.14) \quad A(u) = 0$$

has a continuous second derivative and satisfies equation (1.9), and, conversely, each solution u of equation (1.9), having continuous second derivatives and belonging to space E , is a solution of equation (1.14).

PROPOSITION 1.2. *Operator $A(u)$ satisfies a Lipschitz condition on each bounded set of space E .*

THEOREM 1.1. *Let Condition 1.1 be satisfied. Then there exists a bounded symmetric positive definite operator S , acting in space E , such that for arbitrary $u, u_0 \in E$, the estimate*

$$(1.15) \quad \langle A(u) - A(u_0), S(u - u_0) \rangle \geq \|u - u_0\|_{\mu}^2 + \varphi(u, u_0)$$

holds, where $\varphi(u, u_0) \rightarrow 0$, if u converges to u_0 weakly.

It follows from this theorem that the following condition, analogous to condition α) of I. V. Skrypnik, holds:

For an arbitrary sequence $u_n \in E$ converging weakly to $u_0 \in E$, the relation

$$\lim_{n \rightarrow \infty} \langle A(u_n), S(u_n - u_0) \rangle \leq 0$$

implies the strong convergence of u_n to u_0 .

We conclude from this that on the boundary Γ of an arbitrary bounded set D in space E a rotation of the vector field $\gamma(A, D)$ can be constructed for operator $A(u)$ exactly as was done in [Skr 1]. The degree constructed in this way is independent of arbitrariness in the choice of operator S , satisfying the conditions of Theorem 1.1.

We have the following *Principle of nonzero rotation*: If $\gamma(A, D) \neq 0$, then equation (1.14) is solvable in D .

We define the concept of homotopy for the operators considered. Let us assume that a deformation of matrix a and of function $F(u)$, appearing on the left side of equation (1.3), is made, i.e., we consider a family of matrices a_τ and functions $F_\tau(u)$ ($\tau \in [0, 1]$). We assume that the following conditions are satisfied:

- 1) a_τ , $\tau \in [0, 1]$, are symmetric positive definite matrices, continuous with respect to τ ;
- 2) $F_\tau(u)$ are continuous with respect to $\tau \in [0, 1]$ for each $u \in \mathbb{R}^n$;
- 3) $F'_\tau(u)$ are continuous matrices with respect to the set of variables $\tau \in [0, 1]$, $u \in \mathbb{R}^n$;
- 4) there exist vector-valued functions $w_+(\tau) \neq w_-(\tau)$, continuous with respect to $\tau \in [0, 1]$, for which $F(w_\pm(\tau)) = 0$;
- 5) for each $\tau \in [0, 1]$ the eigenvalues of the matrices

$$F'_\tau(w_\pm(\tau)) - a_\tau \xi^2$$

lie in the left half-plane for all real ξ .

We now construct the operators $A_\tau(u)$ corresponding to the deformations indicated. We note first that $w_+(\tau)$ and $w_-(\tau)$ are limiting values of the solutions of equation (1.3) for $a = a_\tau$, $F = F_\tau$, i.e., we have the equations (1.4) with $w_+ = w_+(\tau)$, $w_- = w_-(\tau)$. According to this, function ψ has the form (see (1.6)):

$$\psi_\tau(x) = w_-(\tau)\omega(x) + w_+(\tau)(1 - \omega(x)),$$

and functionals ρ and c are:

$$\rho_\tau(u) = \left(\int_{-\infty}^{\infty} |u(x) + \psi_\tau(x) - w_+(\tau)|^2 \sigma(x) dx \right)^{1/2},$$

$$c_\tau = \ln \rho_\tau(u).$$

Operator $A_\tau(u): E \rightarrow E^*$ is given by the equation

$$\langle A_\tau(u), v \rangle = \int_{-\infty}^{\infty} (a_\tau u', (v\mu)') dx$$

$$- \int_{-\infty}^{\infty} (a_\tau \psi''_\tau + c_\tau(u)(u' + \psi'_\tau) + F_\tau(u + \psi_\tau), v)\mu(x) dx \quad (u, v \in E).$$

THEOREM 1.2. *Let D be a bounded domain in space E with boundary Γ , and let $A_\tau(u) \neq 0$ for $u \in \Gamma$, $\tau \in [0, 1]$. Then if conditions 1)–5) are satisfied, it follows that*

$$\gamma(A_0, D) = \gamma(A_1, D).$$

Let $u_0 \in E$ be an isolated stationary point of operator $A(u)$, i.e.,

$$A(u_0) = 0$$

and $A(u) \neq 0$ for $u \neq u_0$ in some neighborhood of point u_0 . Then we define, in the usual way, the index of stationary point u_0 as the rotation of field $A(u)$ on a sphere with center at point u_0 and of sufficiently small radius.

We linearize operator $A(u)$ at the stationary point u_0 . The linearized operator $A'(u_0): E \rightarrow E^*$ is defined in the following way ($u, v \in E$):

$$(1.16) \quad \begin{aligned} \langle A'(u_0)u, v \rangle &= \int_{-\infty}^{\infty} (au', (v\mu)') dx \\ &\quad - \int_{-\infty}^{\infty} [c'(u)(u'_0 + \psi', v) + (c(u_0)u' + F'(u_0 + \psi)u, v)]\mu(x) dx, \end{aligned}$$

where

$$c'(u) = -\frac{\int_{-\infty}^{\infty} (u_0(x) + \psi(x) - w_+, u(x))\sigma(x) dx}{\int_{-\infty}^{\infty} |u_0(x) + \psi(x) - w_+|^2 \sigma(x) dx}.$$

THEOREM 1.3. *Let Condition 1.1 be satisfied. Then there exists a symmetric bounded positive definite linear operator S , acting in space E , such that for arbitrary $u \in E$*

$$\langle A'(u_0)u, Su \rangle \geq \|u\|_{\mu}^2 + \vartheta(u),$$

where $\vartheta(u)$ is a functional defined on E and satisfying the condition $\vartheta(u_n) \rightarrow 0$ as $u_n \rightarrow 0$ weakly in E .

It follows from this theorem, in particular, that the operators indicated in Theorem 1.4 have the Fredholm property.

We introduce operator $J: E \rightarrow E^*$ by the equation

$$\langle Ju, v \rangle = \int_{-\infty}^{\infty} (u, v)\mu(x) dx.$$

We have the following theorem.

THEOREM 1.4. *Let Condition 1.1 be satisfied. Then for all $\lambda \geq 0$ the operator $A'(u_0) + \lambda J$ is a Fredholm operator. For all values of $\lambda \geq 0$, except, possibly, for a finite number, it has a bounded inverse, defined on the whole space E^* .*

This theorem is used to study the isolatedness of a stationary point and to calculate its index.

THEOREM 1.5. *Let u_0 be a stationary point of operator $A(u)$, and let us assume that the equation*

$$A'(u_0)u = 0 \quad (u \in E)$$

has no solutions different from zero. Then the stationary point u_0 is isolated and its index is equal to 1 in absolute value.

We show that the sign of the index may be expressed in terms of the multiplicity of the corresponding eigenvalues, similarly to what is the case for completely continuous vector fields (see, for example, [Kra 2]). With this in mind, we map space E into space E^* with the aid of operator J , and we let $E_0^* = JE$. We consider operator $A_* = A'(u_0)J^{-1}$, acting in space E^* with domain of definition E_0^* . It follows from Theorem 1.4 that operator A_* has no more than a finite number

of negative eigenvalues, while the remaining negative numbers are its regular points. We note that real eigenvalues λ of operator A_* satisfy the equality

$$(1.17) \quad \langle A'(u_0)u, v \rangle = \lambda \int_{-\infty}^{\infty} (u, v) \mu dx$$

for some $u \neq 0$, $u \in E$, and all $v \in E$. Here Ju is an eigenfunction of operator A corresponding to eigenvalue λ . Actually, this is the usual definition of eigenfunctions for differential operators in the class of generalized solutions from $W_{2,\mu}^1$.

THEOREM 1.6. *If the conditions of Theorem 1.5 are fulfilled, the index of stationary point u_0 is equal to $(-1)^\nu$, where ν is the sum of the multiplicities of the negative eigenvalues of operator A_* .*

§2. Estimate of linear operators from below

In this section we obtain estimates, first, for linear differential operators with constant coefficients, then for operators with variable coefficients. These estimates will be used in §3 in proving Theorem 1.1; however, they are presented independently since, apparently, they have significance in their own right.

2.1. Constant coefficients. We consider here the operator $L: W_2^1 \rightarrow (W_2^1)^*$, given by

$$(2.1) \quad \langle Lu, v \rangle = \int_{-\infty}^{\infty} [(au', v') - (bu, v)] dx \quad (u, v \in W_2^1),$$

where a is a symmetric positive definite matrix, and a and b are constant matrices. We shall assume that a condition analogous to Condition 1.1 is satisfied.

CONDITION 2.1. *All eigenvalues of the matrix $b - a\xi^2$ lie in the left half-plane for all real ξ .*

THEOREM 2.1. *There exists a symmetric bounded positive definite linear operator T , acting in space W_2^1 , such that for arbitrary $u \in W_2^1$*

$$(2.2) \quad \langle Lu, Tu \rangle = \|u\|^2,$$

where $\| \cdot \|$ is the norm in W_2^1 .

PROOF. We seek operator T with the aid of the Fourier transform. Equation (2.2) takes the form

$$(2.3) \quad \int_{-\infty}^{\infty} ((a\xi^2 - b)\tilde{u}, \tilde{T}u) d\xi = \int_{-\infty}^{\infty} ((1 + \xi^2)\tilde{u}, \tilde{u}) d\xi,$$

where “ \sim ” indicates the image in the transform space.

We set

$$(2.4) \quad \tilde{T}u = R(\xi)\tilde{u}(\xi),$$

where $R(\xi)$ is a symmetric matrix which should be constructed. To construct it we consider the equation

$$(2.5) \quad ((a\xi^2 - b)p, R(\xi)p) = ((1 + \xi^2)p, p),$$

where p is an arbitrary vector.

Let

$$c(\xi) = \frac{1}{1 + \xi^2}(-a\xi^2 + b),$$

so that

$$(2.6) \quad (c(\xi)p, R(\xi)p) = -(p, p).$$

As $R(\xi)$ we take the matrix

$$(2.7) \quad R(\xi) = 2 \int_0^\infty e^{c^*(\xi)s} e^{c(\xi)s} ds,$$

where $c^*(\xi)$ is the matrix conjugate to $c(\xi)$. It is easy to see that the integral in (2.7) exists. Indeed, by virtue of Condition 2.1, there exists a contour Γ such that the spectrum of matrix $c(\xi)$ lies inside this contour for all real ξ , and is also in the half-plane $\text{Re } \lambda < -\omega$, where ω is a positive number.

We have

$$e^{c(\xi)s} = \frac{1}{2\pi i} \int_\Gamma e^{s\lambda} (\lambda I - c(\xi))^{-1} d\lambda,$$

from which we obtain an inequality for the norm of the matrix:

$$\|e^{c(\xi)s}\| \leq M e^{-\omega s},$$

where M is a constant.

Similarly,

$$\|e^{c^*(\xi)s}\| \leq M e^{-\omega s}.$$

It follows that the integral in (2.7) exists and $R(\xi)$ is a symmetric continuous and bounded matrix. Since

$$Rc + c^*R = 2 \int_0^\infty \frac{d}{ds} [e^{c^*(\xi)s} e^{c(\xi)s}] ds = -2I,$$

then (2.6) holds and, consequently, so does (2.5). We define operator T on vector-valued functions $u \in W_2^1$ by means of equation (2.4). Then, by virtue of (2.5), relation (2.3) is valid, and, consequently, so is (2.2). Obviously, the operator defined by equation (2.4) satisfies all conditions of the theorem. \square

2.2. Variable coefficients. Here we consider operator $L: W_2^1 \rightarrow (W_2^1)^*$, given by the equality

$$\langle Lu, v \rangle = \int_{-\infty}^{+\infty} [(au', v') - (b(x)u, v)] dx \quad (u, v \in W_2^1),$$

where a is a constant symmetric positive definite matrix and $b(x)$ is a continuous square matrix with limits at the infinities:

$$b_1 = \lim_{x \rightarrow -\infty} b(x), \quad b_2 = \lim_{x \rightarrow \infty} b(x).$$

THEOREM 2.2. *Let matrices b_1 and b_2 satisfy Condition 2.1. Then there exists a symmetric bounded positive definite operator S_0 , acting in the space W_2^1 , such that for arbitrary $u \in W_2^1$*

$$(2.8) \quad \langle Lu, S_0u \rangle \geq \|u\|^2 + \theta(u),$$

where $\theta(u)$ is a functional defined on W_2^1 and satisfying the condition $\theta(u_n) \rightarrow 0$ as $u_n \rightarrow 0$ weakly.

PROOF. We first consider the case

$$b(x) = b_0(x),$$

where

$$b_0(x) = \varphi_1(x)b_1 + \varphi_2(x)b_2,$$

$\varphi_i(x)$ ($i = 1, 2$) are smooth functions, $0 \leq \varphi_i(x) \leq 1$, $\varphi_1(x) = 0$ for $x > 1$, $\varphi_2(x) = 0$ for $x < -1$, $\varphi_1(x) + \varphi_2(x) = 1$.

Let

$$(2.9) \quad T_0 = \sum_{i=1}^2 \varphi_i(x)T_i\varphi_i(x),$$

where T_i is an operator defined for matrix b_i exactly as was done for matrix b in the preceding section. It is easy to verify that

$$\int_{-\infty}^{+\infty} (au', (T_0u)') dx = \sum_i \int_{-\infty}^{+\infty} (a(\varphi_i u)', (T_i\varphi_i u)') dx + \theta(u)$$

by virtue of the fact that φ_1' has compact support.

Here, and in what follows, $\theta(u)$ denotes functionals satisfying the condition $\theta(u_n) \rightarrow 0$ as $u_n \rightarrow 0$ weakly. Similarly,

$$\int_{-\infty}^{\infty} (bu, T_0u) dx = \sum_i \int_{-\infty}^{\infty} (b_i\varphi_i u, T_i\varphi_i u) dx + \theta(u).$$

Thus

$$(2.10) \quad \begin{aligned} \langle Lu, T_0u \rangle &= \sum_i \int_{-\infty}^{\infty} ((a(\varphi_i u)', (T_i\varphi_i u)') - (b_i\varphi_i u, T_i\varphi_i u)) dx + \theta(u) \\ &= \sum_i \|\varphi_i u\|^2 + \theta(u) \geq \frac{1}{2}\|u\|^2 + \theta(u) \end{aligned}$$

on the basis of results of the preceding section, since

$$(T_i\varphi_i u)' = T_i(\varphi_i u)'$$

Now let $b(x)$ be an arbitrary matrix satisfying the condition of the theorem. Then, obviously,

$$\int_{-\infty}^{\infty} [(b - b_0)u, u] dx = \theta(x)$$

and from (2.10) it follows that

$$\langle Lu, T_0u \rangle \geq \frac{1}{2}\|u\|^2 + \theta(u),$$

in the case considered.

To prove the theorem it remains to show that

$$(2.11) \quad T_0 = \frac{1}{2}S_0 + K,$$

where S_0 is a positive definite symmetric operator and K is a completely continuous operator in W_2^1 .

Let

$$[u, v] = \int_{-\infty}^{\infty} [(u', v') + (u, v)] dx.$$

Obviously,

$$\begin{aligned} [T_0 u, v] - [u, T_0 v] &= \sum_{i=1}^2 \int_{-\infty}^{\infty} [(\varphi'_i T_i \varphi_i u + \varphi_i T_i \varphi'_i u, v') \\ &\quad - (u', \varphi'_i T_i \varphi_i v + \varphi_i T_i \varphi'_i v)] dx. \end{aligned}$$

We denote the right-hand side of this equation by $\Phi(u, v)$. It is clear that $\Phi(u, v)$ is a bounded bilinear functional in W_2^1 and, therefore,

$$\Phi(u, v) = [u, K_0 v] \quad (u, v \in W_2^1),$$

where K_0 is a linear bounded operator.

We show that K_0 is completely continuous. Let $v_n \rightarrow 0$ weakly in W_2^1 . Let $y_n = K_0 v_n$. Then

$$\|y_n\|^2 = [y_n, K_0 v_n] = \Phi(y_n, v_n).$$

It follows from Lemma 2.1 below that $\Phi(y_n, v_n) \rightarrow 0$, from which it follows that operator K_0 is completely continuous. Thus we have shown that

$$(2.12) \quad T_0^* - T_0 = K_0$$

is a completely continuous operator.

Next, we have

$$[T_0 u, v] + [u, T_0 v] = \Phi_1(u, v) + \Phi_2(u, v),$$

where

$$\begin{aligned} \Phi_1(u, v) &= \sum_{i=1}^2 \int_{-\infty}^{\infty} [((T_i \varphi_i u)', (\varphi_i v')) + ((\varphi_i u)', (T_i \varphi_i v)') \\ &\quad + 2(T_i \varphi_i u, \varphi_i v)] dx, \\ \Phi_2(u, v) &= \sum_{i=1}^2 \int_{-\infty}^{\infty} [(\varphi'_i T_i \varphi_i u, v') - ((T_i \varphi_i u)', \varphi'_i v) \\ &\quad + (u', \varphi'_i T_i \varphi_i v) - (\varphi'_i u, (T_i \varphi_i v)')] dx. \end{aligned}$$

Since Φ_1 and Φ_2 are bilinear bounded functionals in W_2^1 , we have

$$\Phi_1(u, v) = [S_0 u, v], \quad \Phi_2(u, v) = [B u, v],$$

where S_0 and B are bounded linear operators. Operator S_0 is symmetric since the functional $\Phi_1(u, v)$ is symmetric and positive definite by virtue of the positive definiteness of operators T_i . As was the case above, it follows from Lemma 2.1 that operator B is completely continuous. The equality $T_0 + T_0^* = S_0 + B$ and (2.12) imply (2.11), where $K = 1/2(B - K_0)$. This completes the proof of the theorem. \square

Use was made of the following lemma whose proof we shall not present because of its simplicity.

LEMMA 2.1. *Let two sequences f_n, g_n of vector-valued functions be given, where $f_n \in L_2$ and is bounded, $g_n \in W_2^1$ and converges weakly to zero in W_2^1 . Assume, further, that $\psi \in L_2$. Then*

$$\int_{-\infty}^{\infty} \psi(x)(f_n, g_n) dx \xrightarrow{n \rightarrow \infty} 0.$$

2.3. Weighted norms. In this section we obtain estimates in the weighted spaces $W_{2,\mu}^1$.

We consider the operator $L: W_{2,\mu}^1 \rightarrow (W_{2,\mu}^1)^*$, given by the equation

$$(2.13) \quad \langle Lu, v \rangle = \int_{-\infty}^{\infty} [(au', v) - (b(x)u, v)]\mu(x) dx \quad (u, v \in W_{2,\mu}^1),$$

where a and b have the same meaning as in §2.2.

THEOREM 2.3. *Let matrices b_1 and b_2 satisfy Condition 2.1. Then there exists a symmetric bounded positive definite operator S , acting in the space $W_{2,\mu}^1$, such that for arbitrary $u \in W_{2,\mu}^1$*

$$(2.14) \quad \langle Lu, Su \rangle \geq \|u\|_{\mu}^2 + \theta_{\mu}(u),$$

where $\| \cdot \|_{\mu}$ is the norm in $W_{2,\mu}^1$, and $\theta_{\mu}(u)$ is a functional defined on $W_{2,\mu}^1$ and satisfying the condition $\theta_{\mu}(u_n) \rightarrow 0$ as $u_n \rightarrow 0$ weakly.

PROOF. Let

$$(2.15) \quad T = \omega^{-1}T_0\omega,$$

where $\omega = \sqrt{\mu}$ and T_0 is given by (2.9). Introducing the notation

$$w = \omega u,$$

we obtain

$$(2.16) \quad \begin{aligned} \langle Lu, Tu \rangle &= \int_{-\infty}^{\infty} [(aw', (T_0w)') - (bw, T_0w)] dx \\ &+ \int_{-\infty}^{\infty} [(a\omega(\omega^{-1})'w, (T_0\bar{w})') + (aw', \omega(\omega^{-1})'T_0w) \\ &\quad + (a\omega(\omega^{-1})'w, \omega(\omega^{-1})'T_0w)] dx. \end{aligned}$$

The following proposition is easily verified: the operation of multiplication by ω is a bounded operator from $W_{2,\mu}^1$ into W_2^1 , and the operation of multiplication by ω^{-1} is a bounded operator from W_2^1 into $W_{2,\mu}^1$.

It follows from this that $w \in W_2^1$, and, by virtue of inequality (2.10), we have

$$\int_{-\infty}^{\infty} [(aw', (T_0w)') - (bw, T_0w)] dx \geq \frac{1}{2}\|w\|^2 + \theta(w) \geq c\|u\|_{\mu}^2 + \theta_{\mu}(u),$$

where c is a positive constant determined by the norm of the operator of multiplication $\omega^{-1}: W_2^1 \rightarrow W_{2,\mu}^1$.

It is easy to verify that the second integral on the right in (2.16) tends towards zero when $w \rightarrow 0$ weakly in W_2^1 .

Thus we have established the inequality

$$\langle Lu, Tu \rangle \geq c \|u\|_\mu^2 + \theta_\mu(u).$$

For a full proof of the theorem it is sufficient to show that

$$(2.17) \quad T = cS + K,$$

where S is a symmetric positive definite operator and K is a completely continuous operator in $W_{2,\mu}^1$.

With this in mind, we construct operators in $W_{2,\mu}^1$ with respect to operators given in W_2^1 in the following way. To each linear bounded operator A acting in W_2^1 , we associate a linear operator A_μ , acting in $W_{2,\mu}^1$ according to the following rule:

$$(2.18) \quad [u, A_\mu v]_\mu = [\omega u, A \omega v] \quad (u, v \in W_{2,\mu}^1),$$

where, as above, $[\]_\mu$ and $[\]$ are inner products in the spaces $W_{2,\mu}^1$ and W_2^1 , respectively.

Proceeding, according to this rule, into equation (2.11) to operators in the space $W_{2,\mu}^1$, we obtain

$$T_{0\mu} = \frac{1}{2} S_{0\mu} + K_\mu,$$

where, based on Lemma 2.2 presented below, $S_{0\mu}$ is a bounded symmetric positive definite operator, and K_μ is a completely continuous operator in $W_{2,\mu}^1$.

By virtue of this lemma and the equality

$$T = \omega^{-1} T_0 \omega,$$

we obtain

$$T_{0\mu} = T + B,$$

where B is a completely continuous operator. Relation (2.17) follows from this with

$$S = \frac{1}{2c} S_{0\mu}, \quad K = K_\mu - B.$$

This completes the proof of the theorem. □

LEMMA 2.2. *Let operator A_μ acting in the space $W_{2,\mu}^1$ be defined by equation (2.18) from operator A acting in the space W_2^1 . Then:*

1. A_μ is a linear bounded operator;
2. A_μ is a completely continuous operator in the space $W_{2,\mu}^1$ if A is a completely continuous operator in W_2^1 ;
3. A_μ is a symmetric positive definite operator in $W_{2,\mu}^1$ if A is a symmetric positive definite operator in W_2^1 ;
4. We have

$$A_\mu = \omega^{-1} A \omega + B,$$

where B is a completely continuous operator acting in the space $W_{2,\mu}^1$.

PROOF. Assertions 1–3 may be verified directly. We prove assertion 4. Let $\tilde{A} = \omega^{-1}A\omega$. This is a bounded operator in the space $W_{2,\mu}^1$. We have, for $u, v \in W_{2,\mu}^1$,

$$[u, \tilde{A}v]_\mu = \int_{-\infty}^{\infty} [(u', (\tilde{A}v)') + (u, \tilde{A}v)]_\mu dx.$$

Let $y = \omega u, z = \omega v$. Then

$$(2.19) \quad [u, \tilde{A}v]_\mu = [y, Az] + \Phi(y, z),$$

where

$$\begin{aligned} \Phi(y, z) = \int_{-\infty}^{\infty} [((\omega^{-1})'\omega y, (Az)') + (y', (\omega^{-1})'\omega Az) \\ + ((\omega^{-1})'\omega y, (\omega^{-1})'\omega Az)] dx. \end{aligned}$$

$\Phi(y, z)$ is a bilinear bounded functional in the space W^1 . Therefore,

$$(2.20) \quad \Phi(y, z) = [y, Kz],$$

where K is a bounded operator in W_2^1 . As was the case above, using Lemma 2.1 we prove that K is a completely continuous operator. It follows from assertion 2 that K_μ is a completely continuous operator in $W_{2,\mu}^1$. From (2.19) and (2.20) we obtain

$$[u, \tilde{A}v]_\mu = [u, A_\mu v]_\mu + [u, K_\mu v]_\mu,$$

i.e.,

$$\tilde{A} = A_\mu + K_\mu.$$

This completes the proof of the lemma. \square

§3. Functional $c(u)$ and operator $A(u)$

Here we prove the assertions formulated in §1 relating to the functional $c(u)$ and the operator $A(u)$.

PROOF OF PROPOSITION 1.1. For arbitrary $u_1, u_2 \in E$ from (1.11) we have

$$|\rho(u_1) - \rho(u_2)| \leq \left(\int_{-\infty}^{\infty} |u_1 - u_2|^2 \sigma(x) dx \right)^{1/2},$$

whence

$$(3.1) \quad |\rho(u_1) - \rho(u_2)| \leq \|u_1 - u_2\|_\mu.$$

We now estimate the functional $\rho(u)$ from below. For arbitrary $N > 1$ we have

$$\rho(u) \geq \left(\int_{-N}^{-1} |u(x) + \psi(x) - w_+|^2 \sigma(x) dx \right)^{1/2}.$$

From this, by virtue of (1.6) and the monotonicity of $\sigma(x)$, we obtain

$$\begin{aligned} \rho(u) &\geq \left(\int_{-N}^{-1} |u(x) + w_- - w_+|^2 dx \right)^{1/2} \sqrt{\sigma(-N)} \\ &\geq (|w_- - w_+| \sqrt{N-1} - \|u\|_\mu) \sqrt{\sigma(-N)}. \end{aligned}$$

Let u lie in the ball $\|u\|_\mu \leq R$. Then, selecting N so that

$$|w_- - w_+| \sqrt{N-1} - R > 1,$$

we obtain

$$\rho(u) > \sqrt{\sigma(-N)}.$$

It follows from this and (3.1) that the functional $c(u)$ satisfies a Lipschitz condition on each bounded set.

Let $u_h(x) = u(x+h) + \psi(x+h) - \psi(x)$. We have

$$(3.2) \quad \rho(u_h) = \left(\int_{-\infty}^{\infty} |u(x) + \psi - w_+|^2 \sigma(x-h) dx \right)^{1/2}.$$

For $h_1 > h_2$ we have $\sigma(x-h_1) < \sigma(x-h_2)$ and, consequently, $\rho(u_{h_1}) < \rho(u_{h_2})$. Thus, $c(u_h)$ is a decreasing function of h . Using the monotonicity of σ and the well-known theorems concerning passage to the limit under the integral sign, we find that $\rho(u_h) \rightarrow 0$ as $h \rightarrow +\infty$, and $\rho(u_h) \rightarrow \infty$ as $h \rightarrow -\infty$. Proposition 1.1 is thereby established. \square

We turn now to the operator $A(u)$. We note first that the integrals appearing in definition (1.13) exist. We need only verify existence of the integral

$$I = \int_{-\infty}^{\infty} (f(u + \psi), v) \mu(x) dx.$$

We note that the estimate

$$(3.3) \quad |u(x)| \leq \frac{(1 + \varkappa)^{1/2}}{(\mu(x))^{1/2}} \|u\|_\mu$$

holds, where

$$\varkappa = \sup_x \frac{|\mu'(x)|}{\mu(x)}.$$

We have

$$f(u + \psi) - f(\psi) = b(x)u,$$

where

$$b(x) = \int_0^1 f'(tu(x) + \psi(x)) dt$$

and is a bounded function of x by virtue of (3.3). Further,

$$I = \int_{-\infty}^{\infty} (b(x)u, v) \mu(x) dx + \int_{-\infty}^{\infty} (f(\psi), v) \mu(x) dx.$$

Existence of the first of the integrals follows from the boundedness of $b(x)$, and existence of the second follows from the fact that $f(\psi(x)) = 0$ for $|x| > 1$.

PROOF OF PROPOSITION 1.2. Let $u_1, u_2 \in E$, $\|u_1\|_\mu \leq R$, $\|u_2\|_\mu \leq R$, where R is a positive number. For $v \in E$ we have

$$\begin{aligned} & \langle A(u_1) - A(u_2), v \rangle \\ &= \int_{-\infty}^{\infty} [(a(u'_1 - u'_2), v) + (a(u'_1 - u'_2), \nu v) - (c(u_1)(u'_1 + \psi') \\ & \quad - c(u_2)(u'_2 + \psi') + f(u_1 + \psi) - f(u_2 + \psi), v)] \mu(x) dx, \end{aligned}$$

where $\nu = \mu'/\mu$. Estimating each term in the usual way, and taking into account the fact that $c(u)$ satisfies a Lipschitz condition, we have

$$|\langle A(u_1) - A(u_2), v \rangle| \leq K \|u_1 - u_2\|_\mu \|v\|_\mu.$$

The proposition is thereby proved. \square

PROOF OF THEOREM 1.1. We take the operator S constructed in the proof of Theorem 2.3 as the operator S appearing in the condition of the theorem. Let $v_n = u_n - u_0$, where $u_n \rightarrow u_0$ weakly.

We have

$$(3.4) \quad \begin{aligned} \langle A(u_n), Sv_n \rangle &= \int_{-\infty}^{\infty} [(au'_n, (Sv_n)') + (au'_n, \nu Sv_n) \\ & \quad - (a\psi'' + c(u_n)(u'_n + \psi') + f(u_n + \psi), Sv_n)] \mu(x) dx. \end{aligned}$$

We consider first the first term on the right,

$$(3.5) \quad \int_{-\infty}^{\infty} (au'_n, (Sv_n)') \mu(x) dx = \int_{-\infty}^{\infty} (av'_n, (Sv_n)') \mu(x) dx + \varphi(v_n),$$

where

$$\varphi(v) = \int_{-\infty}^{\infty} (au'_0, (Sv)') \mu dx.$$

Obviously, $\varphi \in (W_{2,\mu}^1)^*$; therefore, $\varphi(v_n) \rightarrow 0$ as $n \rightarrow \infty$.

Consider now the second term in (3.4). We have

$$(3.6) \quad \left| \int_{-\infty}^{\infty} (au'_n, \nu Sv_n) \mu dx \right| \leq \left(\int_{-\infty}^{\infty} |au'_n|^2 \mu dx \right)^{1/2} \left(\int_{-\infty}^{\infty} |y_n|^2 \nu^2 dx \right)^{1/2},$$

where we have set $y_n = \sqrt{\mu} Sv_n$.

The first factor on the right-hand side of inequality (3.6) is bounded by a constant independent of n , since u_n is a bounded sequence in $W_{2,\mu}^1$. The second factor in (3.6) tends towards zero. Indeed, since Sv_n converges weakly to zero in $W_{2,\mu}^1$, then y_n converges weakly to zero in W_2^1 , and, therefore, functions $y_n(x)$ converge uniformly to zero on each finite interval and the sequence $y_n(x)$ is uniformly bounded on the whole axis. Thus, since ν^2 is summable, we can then pass to the limit as $n \rightarrow \infty$ in the integral considered.

Further, obviously,

$$(3.7) \quad \int_{-\infty}^{\infty} (a\psi'' + c(u_n)\psi', Sv_n)\mu \, dx \rightarrow 0.$$

We show that

$$(3.8) \quad \int_{-\infty}^{\infty} (u'_n, Sv_n)\mu \, dx \rightarrow 0.$$

For this it is sufficient to show that

$$(3.9) \quad I_n \equiv \int_{-\infty}^{\infty} (v'_n, Tv_n)\mu(x) \, dx \rightarrow 0,$$

since $u'_n = v'_n + u'_0$ and in equation (2.17) K is a completely continuous operator. Taking note of equation (2.15) and setting $w_n = \omega v_n$, we obtain

$$(3.10) \quad I_n \equiv \int_{-\infty}^{\infty} (w'_n, T_0 w_n) \, dx - \int_{-\infty}^{\infty} (\omega' v_n, T_0 w_n) \, dx.$$

The second interval on the right-hand side of (3.10) tends towards zero since $\omega' v_n = \nu w_n$, ν^2 is summable, and the $w_n(x)$ are uniformly bounded on the axis and tend towards zero on each finite interval by virtue of the weak convergence $w_n \rightarrow 0$ in W_2^1 . The first integral on the right-hand side of (3.10) can, by virtue of equation (2.9), be written in the form

$$(3.11) \quad \sum_i \int_{-\infty}^{\infty} ((\varphi_i w_n)', T_i \varphi_i w_n) \, dx - \sum_i \int_{-\infty}^{\infty} (\varphi'_i w_n, T_i \varphi_i w_n) \, dx.$$

Taking the Fourier transform of the first term and using the definition of operator T_i (see §2.1), we find that the first term is equal to zero. The second term in (3.11) tends towards zero, since $\varphi'_i(x) = 0$ for $|x| > 1$. Thus we have established (3.8).

It remains to consider the last term on the right-hand side of equality (3.4). We show that

$$(3.12) \quad \int_{-\infty}^{\infty} (f(u_n + \psi), Sv_n)\mu(x) \, dx = \int_{-\infty}^{\infty} (b(x)v_n, Sv_n)\mu(x) \, dx + \varepsilon_n,$$

where $\varepsilon_n \rightarrow 0$ and

$$(3.13) \quad b(x) = f'(u_0 + \psi).$$

With this in mind, we note that

$$(3.14) \quad f(u_n + \psi) = f(u_0 + \psi) + b_n(x)v_n,$$

where

$$b_n(x) = \int_0^1 f'(tv_n(x) + u_0(x) + \psi(x)) \, dt.$$

Since $v_n \rightarrow 0$ weakly in $W_{2,\mu}^1$, then $\|v_n\|_\mu$ is bounded, $v_n(x) \rightarrow 0$ uniformly on each finite interval, and, from (3.3), in view of the condition $\mu(x) \rightarrow \infty$ as $|x| \rightarrow \infty$, it follows that $v_n(x) \rightarrow 0$ uniformly on the whole axis. Thus, $b_n(x) \rightarrow b(x)$ uniformly on the whole axis. Moreover, $f(u_0 + \psi) \in L_2$ with weight μ . Noting this and (3.14), we readily obtain equation (3.12).

Thus, we have established the equation

$$(3.15) \quad \langle A(u_n), Sv_n \rangle = \int_{-\infty}^{\infty} [(av'_n, (Sv_n)') - b(x)v_n, Sv_n] \mu(x) dx + \varepsilon_n,$$

where $\varepsilon_n \rightarrow 0$.

It follows from equation (3.13) that

$$\lim_{x \rightarrow \infty} b(x) = f'(w_+), \quad \lim_{x \rightarrow -\infty} b(x) = f'(w_-),$$

since $u_0(x) \rightarrow 0$ as $|x| \rightarrow \infty$, by virtue, for example, of estimate (3.3) applied to $u_0(x)$.

Recall that it was assumed that matrices $f'(w_+)$ and $f'(w_-)$ satisfy Condition 1.1. Therefore the conditions for Theorem 2.3 are satisfied and in equation (3.15) we can use the estimate (2.14). This completes the proof of the theorem. \square

§4. Leray-Schauder degree

In this section we prove the results presented in §1 relating to the Leray-Schauder degree. To determine the degree we consider the operator $S^*A(u)$, where S is the operator indicated in Theorem 1.1 and S^* is the operator acting in E^* , adjoint to S :

$$\langle S^*f, u \rangle = \langle f, Su \rangle \quad (u \in E, f \in E^*).$$

From the positive definiteness of operator S we conclude that $S^*f = 0$ if and only if $f = 0$.

It follows from Theorem 1.1 that operator $S^*A(u)$ satisfies condition α) [Skr 1]: for an arbitrary sequence u_n converging weakly to u_0 , the relation

$$\lim_{n \rightarrow \infty} \langle S^*A(u_n), u_n - u_0 \rangle \leq 0$$

implies the strong convergence of u_n to u_0 .

Let D be a bounded domain in space E with boundary Γ , and let

$$(4.1) \quad A(u) \neq 0 \quad (u \in \Gamma).$$

Then $S^*A(u) \neq 0$ for $u \in \Gamma$ and the degree $\gamma(A, D)$ is defined for operator $S^*A(u)$ (see [Skr 1]). We note that this does not depend on arbitrariness in the choice of operator S satisfying the conditions of Theorem 1.1. Actually, we have the following proposition.

PROPOSITION 4.1. *Let S_i , $i = 0, 1$, be bounded symmetric positive definite operators in space E , and suppose that condition α) is satisfied for operator $S_i^*A(u)$. Then when condition (4.1) is satisfied, rotation of the fields $S_0^*A(u)$ and $S_1^*A(u)$ coincide on Γ .*

PROOF. We consider the operators

$$S_t = S_0(1 - t) + S_1t, \quad t \in [0, 1].$$

We show that operator $S_t^*A(u)$ satisfies condition α') [Skf 1], i.e., the convergences $t_n \rightarrow t_0, u_n \rightarrow u_0$, weakly in E , and the relation

$$(4.2) \quad \lim_{n \rightarrow \infty} \langle S_{t_n}^*A(u_n), u_n - u_0 \rangle \leq 0$$

imply that $u_n \rightarrow u_0$, strongly in E .

Indeed, we write (4.2) in the form

$$(4.3) \quad \lim_{n \rightarrow \infty} [(1 - t_n)\langle S_0^*A(u_n), u_n - u_0 \rangle + t_n\langle S_1^*A(u_n), u_n - u_0 \rangle] \leq 0.$$

Let us suppose that $\|u_n - u_0\|_\mu$ does not tend towards zero, so that for some subsequence $n_k, \|u_{n_k} - u_0\|_\mu \geq \delta > 0$.

We can assume that the subsequence is chosen so that each term in (4.3) has a limit. Then the limit of at least one of the terms is less than or equal to zero, and, therefore, $u_{n_k} \rightarrow u_0$. The resulting contradiction shows that operator $S_t^*A(u)$ satisfies condition α'). Moreover, since S_t is positive definite for $t \in [0, 1]$, it then follows from (4.2) that $S_t^*A(u) \neq 0$ for $u \in \Gamma$. Thus (see [Skf 1]) rotation of the fields $S_0^*A(u)$ and $S_1^*A(u)$ coincide. The proposition is thereby proved. \square

We shall refer to $\gamma(A, D)$ as the Leray-Schauder degree or the rotation of the field of operator $A(u)$ on boundary Γ of domain D . We now derive the properties of the degree presented in §1.

The principle of nonzero rotation is a direct consequence of the following: if $A(u) \neq 0$ for $u \in D + \Gamma$, then $\gamma(A, D) = 0$. To prove this it is sufficient to apply the results given in [Skf 1] to operator $S^*A(u)$.

PROOF OF THEOREM 1.2. It may be verified directly that the following inequality holds when conditions 1)–4) are satisfied:

$$(4.4) \quad |\langle A_{\tau_1}(u_1) - A_{\tau_1}(u_2) - A_{\tau_2}(u_1) + A_{\tau_2}(u_2), v \rangle| \leq k_R(\tau_1, \tau_2)\|u\|_\mu\|v\|_\mu$$

for $u_1, u_2 \in E: \|u_1\|_\mu \leq R, \|u_2\|_\mu \leq R$, where R is an arbitrary given positive number.

Here $k_R(\tau_1, \tau_2)$ is a function of the variables $\tau_1, \tau_2 \in [0, 1]$, is bounded, and satisfies the condition

$$\lim_{\tau_1 \rightarrow \tau_2} k_R(\tau_1, \tau_2) = 0.$$

For each $\tau \in [0, 1]$ there exists, on the basis of Theorem 1.1, a bounded symmetric positive definite operator S_τ in space E such that

$$(4.5) \quad \langle A_\tau(u_n), S_\tau(u_n - u_0) \rangle \geq \|u_n - u_0\|_\mu^2 + \varepsilon_{\tau_n},$$

where u_n is an arbitrary sequence in E , converging weakly to $u_0, \varepsilon_{\tau_n} \rightarrow 0$.

Let τ_0 be an arbitrary number from the interval $[0, 1]$. We show that in some neighborhood Δ of point τ_0 the estimate

$$\langle A_\tau(u_n), S_{\tau_0}(u_n - u_0) \rangle \geq \frac{1}{2} \|u_n - u_0\|_\mu^2 + \varepsilon_{\tau_n}$$

holds, where $\varepsilon_{\tau_n} \rightarrow 0$ as $n \rightarrow \infty$, uniformly for $\tau \in \Delta$. Let

$$\varphi_\tau(u) = \langle A_\tau(u_0), S_{\tau_0}(u - u_0) \rangle.$$

We have

$$\begin{aligned} \langle A_\tau(u_n), S_{\tau_0}(u_n - u_0) \rangle &= \langle A_\tau(u_n) - A_\tau(u_0) - A_{\tau_0}(u_n) + A_{\tau_0}(u_0), S_{\tau_0}(u_n - u_0) \rangle \\ &\quad + \varphi_\tau(u_n) + \langle A_{\tau_0}(u_n), S_{\tau_0}(u_n - u_0) \rangle - \varphi_{\tau_0}(u_n). \end{aligned}$$

For Δ sufficiently small, we now obtain from (4.4) and (4.5) for $\tau = \tau_0$

$$(4.6) \quad \langle A_\tau(u_n), S_{\tau_0}(u_n - u_0) \rangle \geq \frac{1}{2} \|u_n - u_0\|_\mu^2 + \varepsilon_{\tau_0} + \varphi_\tau(u_n) - \varphi_{\tau_0}(u_n).$$

We show that $\varphi_{\tau_n}(u_n) \rightarrow 0$ uniformly with respect to τ as $u_n \rightarrow u_0$ weakly. Let us assume the contrary to be true. Then there exists a positive number ε , a sequence u_{n_k} , and a sequence τ_k , which we can assume convergent to some number τ^* , such that

$$(4.7) \quad |\varphi_{\tau_k}(u_{n_k})| > \varepsilon.$$

We have

$$(4.8) \quad \begin{aligned} \varphi_{\tau_k}(u_{n_k}) &= \langle A_{\tau_k}(u_0) - A_{\tau^*}(u_0) - A_{\tau_k}(0) + A_{\tau^*}(0), S_{\tau_0}(u_{n_k} - u_0) \rangle \\ &\quad + \langle A_{\tau_k}(0) - A_{\tau^*}(0), S_{\tau_0}(u_{n_k} - u_0) \rangle + \varphi_{\tau^*}(u_{n_k}). \end{aligned}$$

It follows from inequality (4.4) that the first term tends towards zero as $k \rightarrow \infty$. Convergence of the remaining terms to zero is easily verified directly. Thus, $\varphi_{\tau_k}(u_{n_k}) \rightarrow 0$, which contradicts (4.7).

We show that $\gamma(A_\tau, D)$ is independent of τ for $\tau \in \Delta$. Since the quantity $\gamma(A_\tau, D)$ does not depend on arbitrariness in the choice of operator S_τ satisfying the conditions of Theorem 1.1, we can take $2S_{\tau_0}$ as a possible such operator (see (4.6)). Operator $2S_{\tau_0}^* A_\tau(u)$ satisfies condition α' on interval Δ , i.e., for an arbitrary sequence $\tau_n \rightarrow \tau^*$ and an arbitrary sequence $u_n \rightarrow u_0$ weakly, the relation

$$\lim_{n \rightarrow \infty} \langle 2S_{\tau_0}^* A_{\tau_n}(u_n), u_n - u_0 \rangle \leq 0$$

implies that $u_n \rightarrow u_0$ strongly. This follows directly from (4.6) and the uniform convergence of $\varphi_\tau(u_n)$ to zero.

In addition, it may be verified directly that operator $A_\tau(u)$ is continuous with respect to the set of variables $\tau \in [0, 1]$, $u \in E$. Thus, operator $2S_{\tau_0}^* A_\tau(u)$ establishes a homotopy in the sense of I. V. Skrypnik (see [Skr 1]) and, consequently, $\gamma(A_\tau, D)$ is independent of τ on interval Δ .

Selecting a corresponding interval Δ as a neighborhood of each point $\tau_0 \in [0, 1]$, and then a finite covering, we obtain the result that $\gamma(A_0, D) = \gamma(A_1, D)$. This completes the proof of the theorem. \square

§5. Linearized operator

In this section we prove theorems about the linearized operator $A'(u_0)$ that were presented in §1.

PROOF OF THEOREM 1.3. Let $b(x) = f'(u_0(x) + \psi(x))$. Let L be an operator from E to E^* defined by equation (2.13). Then

$$(5.1) \quad A'(u_0) = L + K,$$

where K is defined by

$$(5.2) \quad \langle Ku, v \rangle = \int_{-\infty}^{\infty} (au', v)\mu' dx - \int_{-\infty}^{\infty} (c'(u)(u'_0 + \psi') + c(u_0)u', v)\mu dx.$$

We consider the first term on the right side of (5.2):

$$(5.3) \quad \int_{-\infty}^{\infty} (au', v)\mu' dx = - \int_{-\infty}^{\infty} (au, v')\mu' dx - \int_{-\infty}^{\infty} (au, v)\mu'' dx.$$

Let $u_n \rightarrow 0$ weakly in E . We then have

$$(5.4) \quad \left| \int_{-\infty}^{\infty} (au_n, v')\mu' dx \right| \leq \left(\int_{-\infty}^{\infty} \nu^2 |au_n|^2 \mu dx \right)^{1/2} \|v\|_{\mu}.$$

Since $u_n \rightarrow 0$, then $|u_n(x)|^2 \mu(x)$ is uniformly bounded and converges to zero for each x . Further, ν^2 is summable. Therefore the integral appearing on the right-hand side of (5.4) tends towards zero. In exactly the same way, we may consider the second term on the right-hand side of (5.3). Precisely as in the proof of Theorem 1.1 (see (3.8)), we show that

$$\int_{-\infty}^{+\infty} (u'_n, Su_n)\mu dx \rightarrow 0.$$

Taking into account the fact that $c'(u)$ is a linear bounded functional in E , we find that $\langle Ku_n, Su_n \rangle \rightarrow 0$ if $u_n \rightarrow 0$ weakly.

We obtain the conclusion of the theorem from (5.1) and Theorem 2.3. This completes the proof of the theorem. \square

LEMMA 5.1. *Let $A: E \rightarrow E^*$ be a bounded linear operator, and assume we have the estimate*

$$(5.5) \quad \langle Au, Su \rangle \geq \|u\|_{\mu}^2 + \theta(u),$$

where $\theta(u_n) \rightarrow 0$ if $u_n \rightarrow 0$ weakly and S is a bounded linear operator, acting in E and having a bounded inverse defined on all of E . Then operator A has the Fredholm property, i.e., its image is closed, the kernel and cokernel are finite-dimensional, and their dimensions are equal to one another.

PROOF. We show that the subspace N of solutions of equation

$$(5.6) \quad Au = 0 \quad (u \in E)$$

is finite-dimensional. To do this it is sufficient to prove compactness of the unit sphere. Let $\{u_n\}$ be an infinite sequence of elements from N , $|u_n| = 1$. By

virtue of the weak compactness of the unit sphere, there exists a weakly converging subsequence $\{u_{n_k}\}$, $u_{n_k} \rightarrow u_0$ weakly. According to (5.5)

$$\langle Au_{n_k} - Au_0, S(u_{n_k} - u_0) \rangle \geq \|u_{n_k} - u_0\|_\mu^2 + \theta(u_{n_k} - u_0).$$

Since $u_{n_k} \in N$, then $\|u_{n_k} - u_0\|_\mu^2 \rightarrow 0$. This proves compactness of the unit sphere.

We show, next, that the image $R(A)$ of operator A is closed in E^* . Let $\varphi_n \in R(A)$, $\varphi_n \rightarrow \varphi$. We need to show that $\varphi \in R(A)$. We have

$$Au_n = \varphi_n \quad (u_n \in E).$$

We represent space E in the form of a direct sum

$$E = E_0 \dot{+} N,$$

where E_0 is a subspace in E . We have

$$u_n = w_n + z_n, \quad Aw_n = \varphi_n \quad (w_n \in E_0, \quad z_n \in N).$$

We show that the sequence $\{w_n\}$ is bounded. Let us assume the contrary: $\|w_{n_k}\|_\mu \rightarrow \infty$. We let

$$(5.7) \quad y_{n_k} = \frac{w_{n_k}}{\|w_{n_k}\|_\mu},$$

so that

$$(5.8) \quad \|y_{n_k}\|_\mu = 1.$$

We have

$$(5.9) \quad Ay_{n_k} = \frac{\varphi_{n_k}}{\|w_{n_k}\|_\mu} \rightarrow 0.$$

With no loss of generality, we can assume that y_{n_k} converges weakly. We denote the weak limit by y_0 . From inequality (5.5) we have

$$\langle Ay_{n_k} - Ay_0, y_{n_k} - y_0 \rangle \geq \|y_{n_k} - y_0\|_\mu^2 + \theta(y_{n_k} - y_0).$$

It follows from this that

$$\|y_{n_k} - y_0\|_\mu \rightarrow 0.$$

By virtue of (5.8), $\|y_0\|_\mu = 1$. From (5.7) it follows that $y_0 \in E_0$. On the other hand, from (5.9) we find that $Ay_0 = 0$, which leads to a contradiction. Thus we have shown that the sequence $\{w_n\}$ is bounded. Going over to subsequences and keeping the same notation, we can assume that w_n converges weakly to some element $w_0 \in E$. From (5.5) we have

$$(5.10) \quad \langle Aw_n - Aw_0, S(w_n - w_0) \rangle \geq \|w_n - w_0\|_\mu^2 + \theta(w_n - w_0).$$

Since Aw_n converges strongly to φ , we then find from (5.10) that

$$\|w_n - w_0\|_\mu^2 \rightarrow 0.$$

Thus, $Aw_0 = \varphi$, i.e., $\varphi \in R(A)$.

We now prove the finite-dimensionality of the cokernel of operator A . Taking reflexivity of space E into account, it is sufficient to establish finite-dimensionality of the subspace E_1 of those $v \in E$ for which

$$\langle Au, v \rangle = 0$$

for all $u \in E$. We now prove compactness of the unit sphere in E_1 . Let $\{v_n\}$ be an infinite sequence, $v_n \in E_1$, $\|v_n\|_\mu = 1$. Let

$$w_n = S^{-1}v_n.$$

Then

$$(5.11) \quad \langle Au, Sw_n \rangle = 0$$

for all $u \in E$.

In view of the boundedness of sequence $\{w_n\}$, there exists a weakly convergent subsequence $\{w_{n_k}\}$. We denote its limit by w_0 . From (5.5) it follows that

$$\langle Aw_{n_k} - Aw_0, S(w_{n_k} - w_0) \rangle \geq \|w_{n_k} - w_0\|_\mu^2 + \theta(w_{n_k} - w_0).$$

From (5.11) it follows that the left-hand side tends towards zero. Therefore w_{n_k} converges strongly to w_0 . This establishes compactness of the unit sphere in E_1 .

To complete the proof of the theorem it remains only to show that the index of operator A , i.e., the difference between dimensions of the kernel and cokernel, is equal to zero. To do this we consider an operator B , acting from E into E^* , and defined by the equation

$$\langle Bu, v \rangle = [u, v]_\mu.$$

Obviously, it has a bounded inverse, defined on all of E^* . We consider the operator

$$A(\lambda) = S^*A + \lambda B,$$

where S^* is the operator adjoint to S and λ is a nonnegative number. We have, by virtue of (5.5),

$$\langle A(\lambda)u, u \rangle \geq (1 + \lambda)\|u\|_\mu^2 + \theta(u).$$

Operator $A(\lambda)$ satisfies the condition of the lemma being proved. Therefore, according to what has been proved, it has a closed image and a finite kernel and cokernel. Consequently (see [Gokh 1]), its index does not depend on λ . It follows from the invertibility of B and the boundedness of operator S^*A that for sufficiently large λ the operator $A(\lambda)$ has a bounded inverse defined over all of E^* . Hence, for all $\lambda \geq 0$ the index of operator $A(\lambda)$ is equal to zero. In particular, operator $S^*A = A(0)$ has zero index. Since operator S^* is bounded and has a bounded inverse defined on all of E^* , the index of operator A is then equal to zero. This completes the proof of the lemma. \square

We note that the lemma remains valid for an arbitrary reflexive Banach space E provided that operator $B: E \rightarrow E^*$ exists, is a linear bounded operator, and such that $\langle Bu, u \rangle \geq \|u\|^2$, where $\| \cdot \|$ is the norm in E .

PROOF OF THEOREM 1.4. It follows from Lemma 5.1 and Theorem 1.3 that operator $A'(u_0) + \lambda J$ has the Fredholm property for all $\lambda \geq 0$.

It may be verified directly that

$$\langle A'(u_0)u, u \rangle \geq \int_{-\infty}^{\infty} (au', u')\mu dx - k \int_{-\infty}^{\infty} |u|^2 \mu dx,$$

where k is some number.

It follows from this that there exists a positive number λ_0 such that for $\lambda \geq \lambda_0$ the following inequality holds:

$$\langle A'(u_0)u + \lambda Ju, u \rangle \geq \rho \|u\|_{\mu}^2,$$

where ρ is a positive number.

Thus, operator $A'(u_0) + \lambda J$ has an inverse for $\lambda \geq \lambda_0$.

Consider the interval $[0, \lambda_0]$. For each point λ_* of this interval a number ε can be found such that for all λ satisfying the inequality $0 < |\lambda - \lambda_*| < \varepsilon$ the equation

$$(5.12) \quad A'(u_0)u + \lambda Ju = 0$$

has the same number of linearly independent solutions. We cover interval $[0, \lambda_0]$ by the indicated intervals and select a finite covering. A nonzero solution of equation (5.12) is possible only at the centers of the intervals constituting this finite covering. This completes the proof of the theorem. \square

§6. Index of a stationary point

In this section we prove theorems introduced in §1 referring to the index of a stationary point.

PROOF OF THEOREM 1.5. Let

$$(6.1) \quad \Phi(u) = A(u) - A'(u_0)(u - u_0).$$

It is easy to obtain directly the estimate

$$(6.2) \quad |\langle \Phi(u), v \rangle| \leq M(u_0, u) \|u - u_0\|_{\mu} \|v\|_{\mu},$$

where $M(u_0, u) \rightarrow 0$ as $\|u - u_0\|_{\mu} \rightarrow 0$, i.e., the Fréchet differential of operator $A(u)$ exists.

By virtue of a condition of Theorem 1.5 and the assertion of Theorem 1.4 of §1, operator $A'(u_0)$ has a bounded inverse defined on all of E^* .

Let us assume that u_0 is not an isolated point, i.e., there exists a sequence $u_n \rightarrow u_0$, $u_n \in E$, $A(u_n) = 0$.

From (6.1) we have

$$A'(u_0)(u_n - u_0) = -\Phi(u_n),$$

whence

$$\frac{\|A'^{-1}(u_0)\Phi(u_n)\|_{\mu}}{\|u_n - u_0\|_{\mu}} \geq 1,$$

which, by virtue of (6.2), leads to a contradiction.

Thus we have shown that u_0 is an isolated point.

We consider the operators

$$(6.3) \quad \begin{aligned} B(u) &= A'(u_0)(u - u_0), \\ tA(u) + (1 - t)B(u) &= A'(u_0)(u - u_0) + t\Phi(u). \end{aligned}$$

Let

$$(6.4) \quad \|u - u_0\| = r,$$

where r is so small that

$$(6.5) \quad \|A'^{-1}(u_0)\Phi(u)\|_\mu < \|u - u_0\|_\mu$$

on the sphere (6.4). It follows from (6.5) that operator (6.3) does not vanish on the sphere (6.4) for all t .

By virtue of Theorem 1.3, operator $S^*A'(u_0)(u - u_0)$ satisfies Skrypnik's condition α). Therefore, operator (6.3) satisfies condition α') and the rotations of fields $A(u)$ and $B(u)$ on sphere (6.4) coincide. The index of the stationary point of operator $B(u)$ is equal to ± 1 , which follows from the definition of a rotation of the vector field and corresponding results for finite-dimensional fields. This completes the proof of the theorem. \square

To prove Theorem 1.6 we prove three lemmas.

By virtue of Theorem 1.5 there exists a positive number \varkappa such that operator $A'(u_0) + \lambda J$ has a bounded inverse defined on the whole space E^* for all $\lambda \geq \varkappa$. We consider operator $C = A'(u_0)B^{-1}$, acting in space E^* , where $B = A'(u_0) + \varkappa J$.

LEMMA 6.1. *Operator C has a finite number of negative eigenvalues; the remaining nonpositive numbers are its regular points. The sum of the multiplicities of all the negative eigenvalues of operator C is equal to ν .*

PROOF. Let μ be a negative eigenvalue of operator C , and let f be the corresponding eigenvector:

$$(6.6) \quad Cf = \mu f \quad (f \in E^*).$$

Let $B_* = BJ^{-1}$. Then $C = A_*B_*^{-1}$. Further, we set $g = B_*^{-1}f$. Then

$$A_*g = \lambda g,$$

where

$$(6.7) \quad \lambda = \frac{\varkappa\mu}{1 - \mu}.$$

Hence, λ is a (negative) eigenvalue of operator A_* . Conversely, if λ is a negative eigenvalue of operator A_* , then $\lambda \in (-\varkappa, 0)$ and the number defined by equation (6.7) is an eigenvalue of operator C .

We show that the multiplicities of these eigenvalues coincide. We have

$$(6.8) \quad C - \mu I = (1 - \mu)(A_* - \lambda I)B_*^{-1}.$$

If f is the associated vector of operator C ,

$$(6.9) \quad (C - \mu I)^s f = 0, \quad (C - \mu I)^{s-1} f \neq 0 \quad (s > 1),$$

it then follows from (6.8) that

$$(1 - \mu)^s (A_* - \lambda I)^s B_*^{-s} f = 0,$$

since A_* and B_*^{-1} are commutative. Setting $g = B_*^{-s} f$, we obtain

$$(6.10) \quad (A_* - \lambda I)^s g = 0.$$

Similarly,

$$(6.11) \quad (A_* - \lambda I)^{s-1} g \neq 0.$$

In exactly the same way, we obtain (6.9) from (6.10) and (6.11). This proves the coincidence of the multiplicities of the eigenvalues.

It also follows from equation (6.8) that if $\lambda \in (-\varkappa, 0)$ is a regular point of operator A_* , then the number μ defined by equation (6.7) is a regular point of operator C . This establishes the lemma. \square

By F_0 we denote a subspace of space E^* , which is the union of all root subspaces corresponding to the negative eigenvalues of operator C . The dimension of F_0 is equal to ν . Let P_0 be an operator of projection of E^* onto F_0 such that F_0 and $F_1 = P_1 E^*$ are invariant subspaces of operator C . Here $P_1 = I - P_0$.

We consider the operator $K = B^{-1}(P_0 - CP_0)B$, acting in space E .

LEMMA 6.2. *The sum of the multiplicities of all the negative eigenvalues of operator $I - K$ is equal to ν .*

PROOF. Let λ be a negative eigenvalue of operator $I - K$ of multiplicity $s \geq 1$, u is the associated vector:

$$(6.12) \quad (I - K - I\lambda)^s u = 0, \quad (I - K - I\lambda)^{s-1} u \neq 0 \quad (u \in E).$$

Then

$$(6.13) \quad (P_1 + CP_0 - I\lambda)^s f = 0, \quad (P_1 + CP_0 - \lambda I)^{s-1} f = g,$$

where we have put $f = Bu$, $g \neq 0$.

Taking into account that P_0 and P_1 are commutative with C , and multiplying equations (6.13) on the left by P_0 and P_1 , we obtain

$$(6.14) \quad \begin{aligned} (C - I\lambda)^s P_0 f &= 0, & (C - I\lambda)^{s-1} P_0 f &= P_0 g, \\ P_1(1 - \lambda)^s f &= 0, & P_1(1 - \lambda)^{s-1} f &= P_1 g. \end{aligned}$$

It follows from this that $P_1 f = 0$, $P_1 g = 0$, i.e., $P_0 f = f$, $P_0 g = g$. Also from (6.14) we have

$$(C - I\lambda)^s f = 0, \quad (C - I\lambda)^{s-1} f = g \neq 0.$$

Thus λ is an eigenvalue of operator C of multiplicity s .

It remains to show that an arbitrary negative eigenvalue λ of operator C is also an eigenvalue of operator $I - K$.

Let

$$Cf = \lambda f.$$

Then $P_0f = f$, $P_1f = 0$. Therefore

$$(P_1 + CP_0)f = \lambda f.$$

Setting $u = B^{-1}f$, we obtain from this the result

$$(I - K)u = \lambda u.$$

This completes the proof of the lemma. \square

We introduce operator $J_1: E \rightarrow E^*$ by the equation $\langle J_1u, v \rangle = [u, v]_\mu$ (see (1.10)).

LEMMA 6.3. *Operators $S^*A'(u_0)$ and $J_1(I - K)$ are homotopic.*

PROOF. We introduce the deformation

$$C^t = CP_1(1 - t) + P_1t + CP_0, \quad 0 \leq t \leq 1.$$

It is easy to see that the equation

$$(6.15) \quad C^t f = 0 \quad (f \in E^*)$$

has for all $t \in [0, 1]$ only the zero solution.

Further, we consider the deformation

$$(6.16) \quad L^t = S^*C^tB, \quad 0 \leq t \leq 1.$$

We show that L^t satisfies condition α' . We have

$$L^t = S^*A'(u_0)(1 - t) + S^*Bt + S^*[-CP_0(1 - t) - P_0t + CP_0]B.$$

Since the last term is a finite-dimensional operator and $S^*A'(u_0)$ satisfies condition α , it is then sufficient to show that S^*B satisfies condition α . We have

$$S^*B = S^*A'(u_0) + \varkappa S^*J.$$

Let $u_n \rightarrow 0$ weakly in E and

$$\lim_{n \rightarrow \infty} \langle S^*Bu_n, u_n \rangle \leq 0,$$

i.e.,

$$(6.17) \quad \lim_{n \rightarrow \infty} (\langle A'(u_0)u_n, Su_n \rangle + \varkappa \langle Ju_n, Su_n \rangle) \leq 0.$$

It follows from the construction of operator S (see Theorem 2.3) that

$$\langle Ju_n, Su_n \rangle \geq \langle Ju_n, K_0u_n \rangle,$$

where K_0 is a completely continuous operator in E .

From this and from (6.17) we obtain

$$\lim_{n \rightarrow \infty} \langle A'(u_n)u_n, Su_n \rangle \leq 0$$

and, therefore, (see Theorem 1.3) $u_n \rightarrow 0$ strongly.

Since equation (6.15) has no solutions different from zero, then the same can be said also concerning the equation $L^t u = 0$ ($u \in E$). Thus the operator (6.16) effects a homotopy between the operators

$$L^0 = S^* A'(u_0) \quad \text{and} \quad L^1 = S^* B(I - K).$$

To construct further homotopy, we note first that there exists a positive number μ such that the equation

$$(tB + (1 - t)J_1 + \mu J)u = 0 \quad (u \in E)$$

has for all $t \in [0, 1]$ only the zero solution. This may be proved as was done in §5. Further, we note that if there are two operators A_0 and A_1 from E into E^* satisfying condition α), and if

$$(6.18) \quad A_0 t + A_1(1 - t)$$

does not vanish on nonzero elements of E , then (6.18) is a homotopy. We refer to it as a linear homotopy. To complete the proof of the lemma it is sufficient to note that the following operators are linearly homotopic (in the sequence in which they are written):

$$\begin{aligned} S^* B(I - K), \quad S^*(B + \mu J)(I - K), \\ S^*(J_1 + \mu J)(I - K), \quad (J_1 + \mu J)(I - K), \quad J_1(I - K). \end{aligned}$$

This completes the proof of the lemma. □

PROOF OF THEOREM 1.6. According to Lemma 6.3 the indices of the stationary point $u = 0$ of the operators $S^* A'(u_0)$ and $J_1(I - K)$ coincide. Therefore the theorem will be proved if we can show that rotation of the vector field $J_1(I - K)u$ on the unit sphere $\|u\|_\mu = 1$ is equal to $(-1)^\nu$. To do this, it is sufficient to show, on the basis of Lemma 6.2, that the indicated rotation of the field $J_1(I - K)u$ in the Skrypnik sense coincides with the rotation in the Leray-Schauder sense of the finite-dimensional field $(I - K)u$ on the unit sphere of space E , since the latter is equal to $(-1)^\nu$ (see [Kra 2]).

Let E_0 be the space generated by all the associated vectors of operator $I - K$, and let

$$(6.19) \quad v_1, \dots, v_m$$

be its orthonormalized basis. We extend (6.19) to a complete orthonormalized system in E : $\{v_k\}$. Let $N \geq m$ be a number so large that rotation of the field $J_1(I - K)$ is equal to rotation of the finite-dimensional field Mu :

$$Mu = \sum_{i=1}^N \langle J_1(I - K)u, v_i \rangle v_i$$

on the sphere $\Gamma \cap F_N$, where Γ is given by the equation $\|v\|_\mu = 1$ and F_N is the space spanned by the vectors v_1, \dots, v_N . Obviously,

$$Mu = \sum_{i=1}^N [(I - K)u, v_i]_\mu v_i.$$

We now consider the field $(I - K)u$ in space E and find its rotation on sphere Γ in the sense of Leray-Schauder (see [Kra 2]). We note that

$$KE_0 \subset E_0 \subset F_N.$$

Therefore rotation of field $(I - K)u$ in E on Γ is equal to rotation of the field $u - Ku$ ($u \in \Gamma \cap F_N$) in the space F_N . Since $u \in F_N$ and $Ku \in F_N$, then

$$u - Ku = \sum_{i=1}^N [u - Ku, v_i]_\mu v_i = Mu.$$

This completes the proof of the theorem. □

§7. Supplement. Leray-Schauder degree in the multidimensional case

The theory presented above allows various generalizations. In this section we discuss briefly a generalization to the multi-dimensional case.

We consider the quasilinear elliptic system of equations

$$(7.1) \quad a\Delta w + (r(x') + c)\frac{\partial w}{\partial x_1} + F(w, x) = 0$$

in an infinite cylinder $\Omega \subset \mathbb{R}^m$ with a boundary condition

$$\frac{\partial w}{\partial n} \Big|_{\partial\Omega} = 0$$

and conditions at infinity

$$\lim_{x_1 \rightarrow \pm\infty} w(x) = w_\pm, \quad w_+ \neq w_-.$$

Here $\Omega = D \times \mathbb{R}^1$, D is a bounded domain in \mathbb{R}^{m-1} with a smooth boundary, x_1 is the coordinate along the axis of the cylinder, $x' = (x_2, \dots, x_m)$, $w = (w_1, \dots, w_n)$, $F = (F_1, \dots, F_n)$, a is a constant symmetric positive matrix, $r(x')$ is a scalar function, and w_+ and w_- are constant vectors. Function F can depend on x_1 explicitly. In this case the constant c can be considered as given. If F does not depend on x or depends on x' only, as in the case of wave solutions, c is unknown.

As above, we consider the weighted Sobolev space $W_{2,\mu}^1(\Omega)$ of vector-valued functions, defined in Ω , which have zero normal derivative on the boundary of the cylinder. The inner product in this space has the form:

$$[u, v]_\mu = \int_\Omega \left(\sum_{k=1}^m \left(\frac{\partial u}{\partial x_k}, \frac{\partial v}{\partial x_k} \right) + (u, v) \right) \mu dx.$$

The weight function μ depends on x_1 only and satisfies the conditions:

1. $\mu(x_1) \geq 1$, $\mu(x_1) \rightarrow \infty$ as $|x_1| \rightarrow \infty$,
2. μ'/μ and μ''/μ are continuous functions which tend to zero as $|x_1| \rightarrow \infty$.

The operator $A(u): W_{2,\mu}^1(\Omega) \rightarrow (W_{2,\mu}^1(\Omega))^*$ which corresponds to the left-hand side of (7.1) is given by the equality:

$$\begin{aligned} \langle A(u), v \rangle &= \int_{\Omega} \left(\sum_{k=1}^m \left(a \frac{\partial u}{\partial x_k}, \frac{\partial(v\mu)}{\partial x_k} \right) \right) dx \\ &\quad - \int_{\Omega} \left(a \frac{\partial^2 \psi}{\partial x_1^2} + (r+c) \frac{\partial}{\partial x_1} (u + \psi) + F(u + \psi, x), v \right) \mu dx. \end{aligned}$$

The function $\psi(x_1)$ is defined here as in the one-dimensional case. We assume that $r(x')$ is a bounded function, $F(w, x)$ satisfies the conditions:

1. $F(\psi, x) \in W_{2,\mu}^1(\Omega)$.

In particular, if F does not depend on x and

$$F(w_+) = F(w_-) = 0,$$

then, obviously, this condition is satisfied.

2. The function $F(w, x)$ and the matrices $F'(w, x)$ and $F_i''(w, x)$, $i = 1, \dots, n$, are uniformly bounded for all $w \in \mathbb{R}^n$ and $x \in \Omega$.
3. There exist limits

$$b_{\pm} = \lim_{x \rightarrow \pm\infty} F'(w_{\pm}, x),$$

uniformly in $x' \in D$.

If the constant c is unknown then the functionalization of the parameter should be done similar to that in §1.

If the conditions above and Condition 1.1 are satisfied, then Theorem 1.1 concerning the estimates of the operators is valid. Hence we can conclude that a rotation of a vector field with the usual properties can be constructed.

We consider now the parameter dependent operator $A_{\tau}(u)$:

$$\begin{aligned} \langle A_{\tau}(u), v \rangle &= \int_{\Omega} \left(\sum_{k=1}^m \left(a_{\tau} \frac{\partial u}{\partial x_k}, \frac{\partial(v\mu)}{\partial x_k} \right) \right) dx \\ &\quad - \int_{\Omega} \left(a_{\tau} \psi_{\tau}'' + (r_{\tau} + c_{\tau}) \left(\frac{\partial u}{\partial x_1} + \psi'_{\tau} \right) + F_{\tau}(u + \psi_{\tau}, x), v \right) \mu dx. \end{aligned}$$

We assume that the following conditions are satisfied:

1. The matrices a_{τ} are symmetric positive definite and continuous in τ .
2. The functions $F_{\tau}(\psi_{\tau}, x)$ are continuous in τ in the norm $W_{2,\mu}^1(\Omega)$.
3. The matrices $F'_{\tau}(w, x)$ and $F''_{u_i, \tau}(w, x)$, $i = 1, \dots, n$, are uniformly bounded for all $w \in \mathbb{R}^n$, $x \in \Omega$, $\tau \in [0, 1]$. The matrix $F'_{\tau}(w, x)$ satisfies a Lipschitz condition in $w \in \mathbb{R}^n$, $\tau \in [0, 1]$ uniformly in $x \in \Omega$.
4. For each $\tau \in [0, 1]$ there exist limits

$$b_{\pm}(\tau) = \lim_{x_1 \rightarrow \pm\infty} F'(w_{\pm}(\tau), x),$$

uniformly in $x' \in D$.

5. The functions $r_{\tau}(x')$ are bounded and continuous in τ uniformly with respect to $x' \in D$. If c_{τ} is given, then it is continuous in τ .

The vectors $w_+(\tau)$ and $w_-(\tau)$ are given and continuous in τ ,

$$\psi_\tau(x_1) = w_-(\tau)\omega(x_1) + w_+(\tau)(1 - \omega(x_1)).$$

If c_τ is a functional, then it is given by

$$c_\tau(u) = \ln \rho_\tau(u),$$

$$\rho_\tau(u) = \left(\int_\Omega |u + \psi_\tau - w_+(\tau)|^2 \sigma(x_1) dx \right)^{1/2}.$$

If the eigenvalues of the matrices

$$F'_\tau(w_\pm(\tau)) - a_\tau \xi^2$$

lie in the left half-plane for all $\tau \in [0, 1]$ and ξ real, then the assertion of Theorem 1.2 is valid.

In the multi-dimensional case the theorems concerning the linearized operator and the index of a stationary point are also valid (see §1).

CHAPTER 3

Existence of Waves

§1. Introduction. Formulation of results

Various approaches exist for proving the existence of wave solutions of parabolic equations (see the supplement to this chapter). From among them two basic approaches can be mentioned: study of the phase space of the corresponding first order system of ordinary differential equations, and the Leray-Schauder method, application of which becomes possible after constructing a rotation of the vector field. We can apply, within the scope of the first approach, various topological methods like the Theorem of Waszewski and the Conley Index, or we can try a direct proof of the existence of trajectories joining stationary points (if the question concerns waves having limits at the infinities). For systems of equations with a multi-dimensional phase space, this approach leads, in one way or another, to theoretical difficulties, which, in certain cases, are surmountable. In the transition to multi-dimensional problems such methods cannot be applied directly.

Use of the Leray-Schauder method can also involve certain difficulties. Recall that this method consists in the construction of a continuous deformation (homotopy) of the initial system to a model system, the existence of solutions for which and their properties are known or can be studied. We assume that in the homotopy process there are a priori estimates of solutions, i.e., we can assert that the solutions are found inside some fixed ball in functional space. Then, on the boundary of this ball, the vector field does not vanish and on it we can determine a rotation (Leray-Schauder degree) which by virtue of the properties of this invariant does not change in the homotopy process. Therefore, if the model system is chosen so that for it the degree is different from zero, then the same will also be true for the initial system. Existence of solutions for the initial system follows from this by virtue of the principle of nonzero rotation.

Thus, application of the Leray-Schauder method has two limitations. First, we cannot go beyond the limits of the conditions under which the rotation of the vector field is defined, and, second, obtaining a priori estimates is associated, as a rule, with essential difficulties. However, it should be noted that the rotation of the vector field was defined in Chapter 2 for a fairly broad class of systems and can be generalized, apparently, to other cases, in particular, the multi-dimensional case. As for the second limitation, while earlier restrictions were actually imposed only on the matrices $F'(w_{\pm})$, the possibility of obtaining a priori estimates determines the conditions on the nonlinear source $F(w)$ throughout the domain. One of the basic results of this chapter is the isolation of a class of systems for which it is possible to obtain a priori estimates of solutions, and, furthermore, to prove the existence of waves. As will be shown in Part III, this class of systems includes a large number of the various models from physics, chemistry, and biology.

Recall that rotation of the vector field was defined for the case in which the matrices $F'(w_{\pm})$ have all their eigenvalues in the left half-plane. This is an essential condition connected with the Fredholm property of operators. A question arises concerning the existence of waves if one or both of the matrices $F'(w_{\pm})$ have eigenvalues in the right half-plane. For the class of systems considered this problem can also be solved.

We now present the main results of this chapter. As in the preceding chapter, we consider the system

$$(1.1) \quad \frac{\partial u}{\partial t} = a \frac{\partial^2 u}{\partial x^2} + F(u)$$

and its wave solution

$$(1.2) \quad u(x, t) = w(x - ct),$$

which satisfies the system

$$(1.3) \quad aw'' + cw' + F(w) = 0$$

and the conditions at the infinities

$$(1.4) \quad \lim_{x \rightarrow \pm\infty} w(x) = w_{\pm},$$

where

$$(1.5) \quad F(w_+) = F(w_-) = 0.$$

We assume that the conditions stated in §1 of Chapter 2 are satisfied.

We begin by defining the class of systems to be considered. We note that by means of a linear transformation system (1.1) can be reduced to a system with a diagonal matrix for the second derivatives. Therefore, in what follows, we assume that a is a diagonal matrix with positive diagonal elements.

We formulate conditions on the vector-valued function $F(u)$. We say that the vector-valued function $F(u) = (F_1(u), \dots, F_n(u))$ satisfies a condition of local monotonicity in a domain $G \subset \mathbb{R}^n$ if for any $i = 1, \dots, n$ the equation

$$F_i(u) = 0 \quad (u \in G)$$

implies that

$$(1.6) \quad \frac{\partial F_i}{\partial u_k} > 0 \quad \text{for } k = 1, \dots, n, \quad k \neq i.$$

Further, we say that $F(u)$ satisfies a condition of monotonicity in domain G if (1.6) holds for all $u \in G$, $i \neq k$.

REMARK. The assumption that inequality (1.6) is strict was made for simplicity. In what follows we rid ourselves of this assumption and replace it with weaker restrictions.

DEFINITION 1.1. System (1.1) with diagonal matrix a is said to be locally monotone if $F(u)$ satisfies the condition of local monotonicity in \mathbb{R}^n , and monotone if $F(u)$ satisfies the condition of monotonicity in \mathbb{R}^n .

We denote by P the class of matrices having positive off-diagonal elements. It is clear that if $F(u)$ satisfies the condition of local monotonicity and $F(u) = 0$, then $F'(u) \in P$.

In this chapter we prove the existence of monotone traveling waves, i.e., solutions $w(x)$ of system (1.3) with conditions (1.4), such that $w'(x) < 0$ (similarly, we could consider the case $w'(x) > 0$). Here, and in the sequel, an inequality between vectors is to be understood as an inequality between the corresponding elements. It is obvious that for monotone waves to exist it is necessary for the inequality $w_+ < w_-$ to be satisfied. Replacement of the function $u = Tv + w_+$, where T is a diagonal matrix, with elements of the vector $(w_- - w_+)$ on the diagonal, can reduce problem (1.3), (1.4) to an analogous problem in which

$$(1.7) \quad w_+ = 0, \quad w_- = p,$$

where $p = (1, \dots, 1)$. With such a replacement of variables local monotonicity is not violated. Later on in this section we assume that (1.7) holds.

We note, owing to the possibility of variation of the linear transformation reducing matrix a to a diagonal matrix, that the class of locally monotone systems can be formally extended. (For example, some of the inequalities (1.6) can be replaced by opposite inequalities; this corresponds to a change in the direction of monotonicity in some components of the vector-valued function $w(x)$.)

Proof of the existence of monotone traveling waves for locally monotone systems (1.1) is carried out by the Leray-Schauder method. As we have already remarked, in applying this method it is necessary to construct a homotopy of system (1.3) to some system with a nonzero rotation of the corresponding vector field and to obtain a priori estimates of all solutions.

The system to which the homotopy is carried out has the form

$$(1.8) \quad w'' + cw' + g(w) = 0,$$

where $g(w) = (g_1(w), \dots, g_n(w))$ is a smooth vector-valued function, given in \mathbb{R}^n , and satisfying the conditions

$$\begin{aligned} g_i(w_1, w_2, \dots, w_{i-1}, w_i, w_{i+1}, \dots, w_n) \\ = g_1(w_i, w_2, \dots, w_{i-1}, w_1, w_{i+1}, \dots, w_n), \quad i = 2, \dots, n, \\ \frac{\partial g_1(w)}{\partial w_1} \leq -k, \quad \frac{\partial g_1(w)}{\partial w_i} \geq k, \quad i = 2, \dots, n, \quad w \in \mathbb{R}^n, \quad k > 0, \\ \sum_{i=1}^n \frac{\partial g_1(w_{\pm})}{\partial w_i} < 0, \end{aligned}$$

and the function $g_1(w_1, \dots, w_1)$ has a single zero on the interval $(0, 1)$.

As we shall show, the system constructed may be reduced to a single equation, making it possible to prove the following proposition.

PROPOSITION 1.1. *Problem (1.8), (1.4) has a unique monotone solution $w(x)$. Function $u(x) = w(x) - \psi(x)$ is a stationary point of the corresponding operator $A(u)$ and the index of this stationary point is equal to 1.*

We now present the main result concerning the existence of monotone waves.

THEOREM 1.1. *Let us assume that system (1.1) is locally monotone and that equalities (1.5) are satisfied, where $w_+ < w_-$. Suppose, further, that the vector-valued function $F(u)$ vanishes at a finite number of points u^k , $w_+ \leq u^k \leq w_-$ ($k = 1, \dots, m$). We assume that all the eigenvalues of the matrices $F'(w_{\pm})$ lie in the left half-plane, and that the matrices $F'(u^k)$ ($k = 1, \dots, m$) have at least one*

eigenvalue in the right half-plane. Then there exists a monotone traveling wave, i.e., a constant c and a twice continuously differentiable monotone vector-valued function $w(x)$, satisfying system (1.3) and the conditions (1.4). Moreover, if system (1.1) is monotone, then there exists a unique monotone wave.

There exists a set $\Omega \subset W_{2,\mu}^1$, being the union of a finite number of balls such that $w_M - \psi \in \Omega$, $w_N - \psi \notin \Omega$, where w_M and w_N are arbitrary monotone and non-monotone waves, respectively. Rotation of the field of operator $A(u)$ over the boundary of set Ω is equal to 1.

A generalization of the theorem for the existence of waves in the bistable case is given in §3. In this theorem we consider the case where in the interval (w_+, w_-) there are only unstable zeros of the vector-valued function $F(u)$. (Here we denote by (w_+, w_-) the set of points $w \in \mathbb{R}^n$, such that $w_+ < w < w_-$.) We assume now that in the interval (w_+, w_-) there are, in addition, stable zeros p_1, \dots, p_s , i.e., $F(p_k) = 0$ and the matrix $F'(p_k)$ has all its eigenvalues in the left half-plane ($k = 1, \dots, s$). It is easy to see that from the points p_1, \dots, p_s we can select points p_{i_1}, \dots, p_{i_r} , such that

$$(1.9) \quad w_+ < p_{i_1} < \dots < p_{i_r} < w_-$$

and such that the points p_1, \dots, p_s are not contained in the intervals $(w_+, p_{i_1}), \dots, (p_{i_r}, w_-)$.

By an $[a, b]$ -wave we shall mean a solution $w(x)$ of system (1.3) satisfying the conditions

$$\lim_{x \rightarrow +\infty} w(x) = a, \quad \lim_{x \rightarrow -\infty} w(x) = b.$$

In contrast to the case considered in the theorem, here we have not a wave, but a system of waves, joining the points w_+ and w_- , i.e., a system consisting of $[w_+, p_{i_1}]$, \dots , $[p_{i_r}, w_-]$ -waves. We note that there can be several such systems of waves and that through each of the points p_1, \dots, p_s there passes at least one of them.

Proof of Theorem 1.1 is based on the following proposition.

PROPOSITION 1.2. *Let the conditions of Theorem 1.1 be satisfied. Then there exists a homotopy satisfying conditions 1)–5) (see Chapter 2, §1) and connecting system (1.3) with system (1.8):*

$$(1.10) \quad a_\tau w'' + cw' + F_\tau(w) = 0 \quad (\tau \in [0, 1])$$

such that

1) for some $R > 0$ we have the a priori estimate

$$(1.11) \quad \|w_M - \psi\|_\mu \leq R$$

of all the monotone solutions $w_M(x)$ of system (1.10), satisfying conditions (1.4);

2) for some $r > 0$ we have the estimate

$$\|w_M - w_N\|_\mu \geq r,$$

where w_M and w_N are, respectively, an arbitrary monotone and a nonmonotone solution of system (1.10) with the conditions (1.4).

The proof of this proposition is the subject matter of §2. Here we limit ourselves to explaining the basic idea of obtaining a priori estimates of monotone solutions of system (1.10). In neighborhoods of the points w_+ and w_- the solutions admit

a uniform exponential estimate. The assumption concerning monotonicity of a solution yields an estimate for it in $C(-\infty, +\infty)$ and, as we shall show, also in $C^1(-\infty, +\infty)$. Therefore, to obtain a priori estimates in $W_{2,\mu}^1$ it is sufficient to show that the interval of values of x , on which the solution is found outside of neighborhoods of the points w_+ and w_- , is uniformly bounded. By monotonicity of the solutions, the assumption concerning the absence of uniform boundedness of this interval leads to the fact that for some $\tau \in [0, 1]$ there exist nonconstant solutions $w^1(x)$ and $w^2(x)$ of system (1.10), tending towards some intermediate singular points w_0^1 and w_0^2 , respectively, as $x \rightarrow +\infty$ and $x \rightarrow -\infty$, where

$$w^1(x) > w_0^1, \quad w^2(x) < w_0^2, \quad -\infty < x < +\infty.$$

In the case of a locally monotone system ($\tau \in [0, 1/3)$ or $\tau \in (2/3, 1]$), $w_0^1 = w_0^2$, from which there follows the existence of positive vectors q_1 and q_2 , for which

$$(a\lambda_i^2 + c\lambda_i + F'(w_0^1))q_i = 0,$$

where $\lambda_1 < 0 < \lambda_2$. This cannot be so if the matrix $F'(w_0^1)$ has eigenvalues in the right half-plane. For a degenerate system ($\tau \in [1/3, 2/3]$) solution $w^1(x)$ can exist only for $c > 0$, while solution $w^2(x)$ can exist only for $c < 0$, which also leads to a contradiction.

The discussions mentioned use a priori estimates for the speed of the wave (§ 2.2).

After a priori estimates of monotone solutions have been obtained, to apply the Leray-Schauder method it is sufficient to show that rotation of the vector field can be constructed over boundaries of domains containing only monotone solutions. With this as our aim, we carry out a separation of monotone and nonmonotone solutions. Here we make essential use of the local monotonicity of the system. We remark that the idea of separating monotone and nonmonotone solutions was first proposed by Gardner for a system he considered in [Gard 2].

If system (1.3) is monotone, then the index of the stationary point of operator $A(u)$ corresponding to a monotone wave is equal to 1. This, by virtue of the properties of the degree, leads to uniqueness of a monotone wave. Calculation of the index in the case indicated is based on Proposition 1.3, presented below (which is proved in Chapter 4 in a more general form).

We consider the linear differential operator

$$(1.12) \quad Lu = au'' + cu' + B(x)u,$$

where a is a diagonal matrix with positive diagonal elements, c is a constant, and $B(x)$ is a smooth matrix with positive off-diagonal elements, for which the limits B_{\pm} exist as $x \rightarrow \pm\infty$, where all the eigenvalues of matrices B_{\pm} lie in the left half-plane.

PROPOSITION 1.3. *Let us assume that a positive solution $w(x)$ exists for the equation*

$$(1.13) \quad Lw = 0, \quad w(\pm\infty) = 0.$$

Then

1) *The equation*

$$(1.14) \quad Lu = \lambda u, \quad u(\pm\infty) = 0$$

has no solutions different from zero for $\operatorname{Re} \lambda \geq 0$, $\lambda \neq 0$.

2) *Every solution of equation (1.14) has for $\lambda = 0$ the form $u(x) = kw(x)$, where k is a constant.*

3) *The adjoint equation*

$$(1.15) \quad L^*v = 0, \quad v(\pm\infty) = 0$$

has a positive solution. This solution is unique to within a constant factor.

It follows from this proposition that the linear differential operator obtained by linearization of system (1.3) on a monotone wave has 0 as a simple eigenvalue, and all the remaining eigenvalues have negative real parts. As we shall show in §3, representation of the speed in the form of a functional in the linearization of operator $-A(u)$ moves the zero eigenvalue into the left half-plane, making it possible to apply Theorems 1.5 and 1.6 of Chapter 2.

It also follows from Proposition 1.3 that monotone waves, described by the monotone system (1.1), possess the property of asymptotic stability with shift (see Chapter 5). Introduction of the functional makes them asymptotically stable without shift.

Thus, in the bistable case, i.e., when all the eigenvalues of the matrices $F'(w_{\pm})$ lie in the left half-plane, a monotone wave exists for a monotone system and is unique. For it we also have the following minimax representation of the speed.

Let K denote the class of vector-valued functions $\rho(x) \in C^2(-\infty, +\infty)$, decreasing monotonically and satisfying the conditions $\lim_{x \rightarrow \pm\infty} \rho(x) = w_{\pm}$. Further, let

$$(1.16) \quad \psi_i(\rho(x)) = \frac{a_i \rho_i''(x) + F_i(\rho(x))}{-\rho_i'(x)},$$

where a_i are the diagonal elements of matrix a , and F_i and ρ_i are the elements of the vector-valued functions F and ρ . Let

$$(1.17) \quad \omega_* = \sup_{\rho \in K} \inf_{x,i} \psi_i(\rho(x)),$$

$$(1.18) \quad \omega^* = \inf_{\rho \in K} \sup_{x,i} \psi_i(\rho(x)).$$

For the speed c of a wave we then have

$$(1.19) \quad c = \omega_* = \omega^*.$$

A proof of this result is given in Chapter 5. It is obvious that this formulation will yield two-sided estimates of the speed (see Chapter 10).

We consider now the case where one of the matrices $F'(w_{\pm})$ has an eigenvalue in the right half-plane (the monostable case). For definiteness, let the matrix in question be $F'(w_+)$. We then have the following theorem.

THEOREM 1.2. *We assume that in the interval $[w_+, w_-]$ (i.e., for $w_+ \leq w \leq w_-$) the vector-valued function $f(u)$ vanishes only at the points w_+ and w_- . Then for all $c \geq \omega^*$, where ω^* is given by equation (1.18), there exists a monotonically*

decreasing solution of system (1.3), satisfying conditions (1.4). For $c < \omega^*$ such solutions do not exist.

The proof of this theorem is based on properties of monotone systems and uses neither the Leray-Schauder method nor an analysis of trajectories in phase space. We present this theorem here in a somewhat simplified version. More general results will be given in §4, where we also prove that if each of the matrices $F'(w_+)$ and $F'(w_-)$ has at least one eigenvalue in the right half-plane, then no monotone waves exist.

§2. A priori estimates

2.1. Homotopy. In this section we describe a homotopy of system (1.3) to system (1.8), a topic discussed in Proposition 1.2.

In constructing the vector-valued function $F_\tau(w)$ we introduce a smooth function $\eta(s)$ of the real variable s :

$$\eta(s) = \begin{cases} 1 & \text{for } |s| \leq \delta/2, \\ 0 & \text{for } |s| \geq \delta, \end{cases}$$

where $\eta(s) > 0$ for $|s| < \delta$. The number $\delta > 0$ is chosen so that the matrices $F'(w)$ and $g'(w)$ have positive off-diagonal elements for $|w| \leq \delta$, $|w - p| \leq \delta$. We set

$$(2.1) \quad \omega(w) = \begin{cases} \eta(|w|) & \text{for } |w| \leq \delta, \\ \eta(|w - p|) & \text{for } |w - p| \leq \delta, \\ 0 & \text{for } |w| \geq \delta, \quad |w - p| \geq \delta, \end{cases}$$

and $\omega_\tau(w) = 1 - 3\tau + 3\omega(w)\tau$, $0 \leq \tau \leq 1/3$. Further, we introduce an arbitrary constant matrix H with positive off-diagonal elements, satisfying the inequalities

$$(2.2) \quad H < F'(0), F'(p), g'(0), g'(p).$$

(Each of the inequalities between matrices in (2.2) is to be understood as an inequality between corresponding elements of the matrices.)

The homotopy of system (1.3) to system (1.8) is given by the equality

$$(2.3) \quad a_\tau = \begin{cases} (1 - 3\tau)a + 3\tau E & \text{for } 0 \leq \tau \leq 1/3, \\ E & \text{for } 1/3 \leq \tau \leq 1, \end{cases}$$

where E is the unit matrix

$$(2.4) \quad F_\tau(w) = \begin{cases} F(w)\omega_\tau(w), & 0 \leq \tau \leq 1/3; \\ 3(1 - 2\tau)F(w)\omega(w) + 2(3\tau - 1)h(w), & 1/3 \leq \tau \leq 1/2; \\ 3(2\tau - 1)g(w)\omega(w) + 2(2 - 3\tau)h(w), & 1/2 \leq \tau \leq 2/3; \\ g(w)\omega_{1-\tau}(w), & 2/3 \leq \tau \leq 1; \end{cases}$$

$$h(w) = \eta(|w|)Hw + \eta(|w - p|)H(w - p).$$

Thus, in the first stage of the homotopy ($\tau \in [0, 1/3]$) the matrix of the second derivatives is reduced to the unit matrix, and the vector-valued function $F_\tau(w)$ does not change inside $(\delta/2)$ -neighborhoods of the points 0 and p , and becomes identically equal to 0 outside of δ -neighborhoods of these points.

In the second stage of the homotopy ($\tau \in [1/3, 2/3]$) inside δ -neighborhoods of the points 0 and p the vector-valued function $F(w)$ is homotoped to the vector-valued function $g(w)$. Owing to the choice of matrix H , all the eigenvalues of the matrices $F'_\tau(0)$ and $F'_\tau(p)$ have negative real parts.

In the third stage of homotopy ($\tau \in [2/3, 1]$) the vector-valued function $F_\tau(w)$ becomes equal to $g(w)$ for all $w \in \mathbb{R}^n$.

We note that with the homotopy (2.3), (2.4) the conditions 1)–5) of §1, Chapter 2, are satisfied. The vector-valued function $F_\tau(w)$ satisfies the condition of local monotonicity for all τ in δ -neighborhoods of points 0 and p , and also for all $w \in \mathbb{R}^n$ if $0 \leq \tau < 1/3$ or $2/3 < \tau \leq 1$. This follows from the fact that the condition of local monotonicity is preserved under multiplication by a positive function.

In §§2.2–2.5 of Chapter 4 we obtain a priori estimates of monotone solutions for the homotopy (2.3), (2.4).

2.2. Estimates of derivatives. In this section we obtain estimates of the derivatives $w'(x)$ and $w''(x)$ in $C(-\infty, \infty)$ of solutions $w(x)$ of the system of equations (1.10). Moreover, monotonicity of the solutions is not assumed.

LEMMA 2.1. *Let solution $w(x)$ of system (1.10) satisfy inequality $|w(x)| \leq R$ for all x . Then the derivatives $w'(x)$ and $w''(x)$ may be estimated in the $C(-\infty, \infty)$ norm by a constant, depending only on R , the norm of the matrix a_τ^{-1} , and $\max_{|w| \leq R} |F_\tau(w)|$.*

PROOF. Assume first that $|c| \geq 1$. If for some $x = x_0$ an extremum of function $w'_i(x)$ is attained, then, obviously, $w''_i(x_0) = 0$ and, from the i th equation in (1.10), we have

$$(2.5) \quad |w'_i(x_0)| \leq \max_{|w| \leq R} |F_\tau(w)|.$$

By virtue of the boundedness of function $w_i(x)$, the maximum of $|w'_i(x)|$ for $-\infty < x < \infty$ is attained at extremum points of the derivative; consequently, the estimate (2.5) holds for all x and $i = 1, \dots, n$.

Assume now that $|c| < 1$ and let M_i be the set of those values of x for which $|w'_i(x)| > 1$ ($i = 1, \dots, n$). Obviously, it is sufficient to consider only the case in which M_i is nonempty and to obtain an estimate of the derivative $w'_i(x)$ for $x \in M_i$. Let (α, β) be an arbitrary interval in M_i , $|w'_i(\alpha)| = |w'_i(\beta)| = 1$. Then, for $\alpha < x < \beta$, we obtain, upon integrating the i th equation of system (1.10),

$$a_{\tau_i} [w'_i(x) - w'_i(\alpha)] + c [w_i(x) - w_i(\alpha)] + \int_\alpha^x F_{\tau_i}(w(s)) ds = 0.$$

From this we obtain

$$\begin{aligned} |w'_i(x)| &\leq 1 + \frac{1}{a_{\tau_i}} [|c| (|w_i(x)| + |w_i(\alpha)|) + \max_{|w| \leq R} |F_\tau| (\beta - \alpha)] \\ &\leq 1 + \frac{2R}{a_{\tau_i}} [1 + \max_{|w| \leq R} |F_\tau(w)|], \end{aligned}$$

since $\beta - \alpha \leq |w_i(\beta) - w_i(\alpha)| \leq 2R$.

Thus, for c arbitrary, we have obtained the following estimate:

$$|w'_i(x)| \leq (1 + 2R\|a_\tau^{-1}\|)(1 + \max_{|w| \leq R} |F_\tau(w)|), \quad -\infty < x < \infty, \quad i = 1, \dots, n.$$

We now obtain an estimate of the derivative $w''_i(x)$. From the i th equation in (1.10) we have

$$(2.6) \quad |w''_i(x)| \leq \frac{1}{a_{\tau_i}} (|cw'_i(x)| + |F_{\tau_i}(w(x))|).$$

If an extremum of function $w'_i(x)$ is attained at $x = x_0$, then, as above,

$$|cw'_i(x_0)| \leq \max_{|w| \leq R} |F_\tau(w)|$$

and, from (2.6),

$$|w''_i(x)| \leq 2\|a_\tau^{-1}\| \max_{|w| \leq R} |F_\tau(w)|, \quad -\infty < x < \infty, \quad i = 1, \dots, n.$$

This completes the proof of the lemma. □

2.3. A priori estimates of the speed. In this section we obtain a priori estimates of the speed c of monotone waves, described by the system (1.10), with the condition (1.4).

THEOREM 2.1. *For an arbitrary solution (c, w) of system (1.10) with the condition (1.4), where $w(x)$ is a monotonically decreasing vector-valued function, there is an estimate for the constant c , i.e., the wave speed, that is independent of τ .*

We now prove some auxiliary propositions.

LEMMA 2.2. *Let the vector-valued function $F(w)$ satisfy a condition of local monotonicity in \mathbb{R}^n .*

If $F_i(w^0) \geq 0$ for some i , then $F_i(w) > 0$ for $w_i = w_i^0$, $w_k \geq w_k^0$, $k = 1, \dots, n$, $w \neq w^0$.

If $F_i(w^0) \leq 0$ for some i , then $F_i(w) < 0$ for $w_i = w_i^0$, $w_k \leq w_k^0$, $k = 1, \dots, n$, $w \neq w^0$.

PROOF. We prove the first statement of the lemma. The second is proved in a similar way.

Consider the function

$$\varphi(t) = F_i(w^0(1 - t) + wt), \quad 0 \leq t \leq 1.$$

Owing to the local monotonicity of the vector-valued function $F(w)$, the function $\varphi(t)$ has a positive derivative at those points where it vanishes. Since $\varphi(0) \geq 0$, then $\varphi(1) > 0$. This completes the proof of the lemma. □

LEMMA 2.3. *Let the vector-valued function $F(w)$ satisfy a condition of local monotonicity in \mathbb{R}^n , let $F(0) = 0$, and assume that a positive vector q and a constant $t_0 > 0$ can be found such that*

$$(2.7) \quad F(tq) < 0 \quad \text{for} \quad 0 < t \leq t_0.$$

Then at each point $w \in [0, t_0q]$ (i.e., $0 \leq w \leq qt_0$), $w \neq 0$, at least one of the functions $F_i(w)$ is negative.

PROOF. Let $u_0 \neq 0$ be an arbitrary point on the boundary of the interval $[0, t_0q]$. We consider the solution $u(x)$ of the Cauchy problem

$$(2.8) \quad \frac{du}{dx} = F(u), \quad u(0) = u_0.$$

By the preceding lemma, $u(x) \in (0, qt_0)$ for small positive x . Since the point u_0 is chosen arbitrarily, this means that the trajectories intersect the boundary of the interval $[0, t_0q]$ for $u \neq 0$ from the outside inwards, and no solution $u(x)$ of problem (2.8) for $u_0 \in [0, t_0q]$ can be found outside of this interval. We show, moreover, that $u(x) \rightarrow 0$ as $x \rightarrow \infty$. Indeed, if this is not so, then the ω -limit set of trajectory $u(x)$ contains points different from 0. Hence, we can find $t_1, 0 < t_1 \leq t_0$, such that this ω -limit set is embedded in the interval $[0, t_1q]$ touching its boundaries. The latter contradicts Lemma 2.2.

We assume now that $F(w) > 0$ for some $w \in [0, t_0q]$. By the preceding lemma, $w < t_0q$ and no solution of (2.8) for $u_0 \in [w, t_0q]$ can go outside of this interval. This contradicts the fact that for arbitrary $u_0 \in [0, t_0q]$ the solution $u(x)$ of problem (2.8) tends towards 0. If $F(w) \geq 0$, we can then find a positive component of vector $F(w)$. For definiteness, let $F_1(w) > 0$. By virtue of the local monotonicity condition we can select $\varepsilon > 0$ so small that $\tilde{w} = (w_1 + \varepsilon, w_1, \dots, w_n) \in [0, t_0q]$ and $\tilde{F}(w) > 0$, which leads to the case considered above. This completes the proof of the lemma. \square

PROOF OF THEOREM 2.1. We obtain an upper estimate to the speed. For arbitrary $\tau_0 \in [0, 1]$ all the eigenvalues of the matrix $F'_{\tau_0}(0)$ have negative real parts. Since the off-diagonal elements of this matrix are positive, the matrix has a real negative eigenvalue, which corresponds to the positive eigenvector q_{τ_0} . Therefore, for some t_{τ_0}

$$F_{\tau_0}(tq_{\tau_0}) < 0 \quad \text{for} \quad 0 < t \leq t_{\tau_0}.$$

The inequality

$$F_{\tau}(tq_{\tau_0}) < 0 \quad \text{for} \quad 0 < t \leq t_{\tau_0}$$

remains valid for all τ from some neighborhood $\Delta(\tau_0)$ of point τ_0 . It follows from the preceding lemma that at each point $w \in [0, t_{\tau_0}q_{\tau_0}]$, $w \neq 0$, at least one of the functions $F_{\tau_i}(w)$ is negative, $\tau \in \Delta(\tau_0)$. It follows from this that we can select interval $[0, q]$, $q > 0$, so that for all $\tau \in [0, 1]$ and all $w \in [0, q]$, $w \neq 0$, at least one of the functions $F_{\tau_i}(w)$ is negative. And, finally, it is easy to verify that an $\varepsilon > 0$ can be found, independent of τ , such that in an ε -neighborhood of each point of the set $\Gamma = \{w \in \mathbb{R}^n \mid 0 \leq w \leq q, \exists i: w_i = q_i\}$ at least one of the functions F_{τ_i} is negative, $\tau \in [0, 1]$.

We now proceed directly to an estimate of the speed c . Let us assume, for some τ , that $w(x)$ is a monotone solution of problem (1.10), (1.4). Then for some $x = x_0$, we have $w(x_0) \in \Gamma$. From what has been proved, one of the functions $F_{\tau_i}(w)$ is negative in an ε -neighborhood of the point $w(x_0)$. Assume, for example, that $i = 1$. We select x_1 such that $w_1(x_0) - w_1(x_1) = \varepsilon$ ($w_1(x_0) - \varepsilon > 0$), and we integrate the first equation in (1.10) from x_0 to x_1 :

$$(2.9) \quad a_{\tau_1}[w'_1(x_1) - w'_1(x_0)] + c[w_1(x_1) - w_1(x_0)] + \int_{x_0}^{x_1} F_{\tau_1}(w(x)) dx = 0.$$

We show that

$$(2.10) \quad F_{\tau_1}(w(x)) < 0 \quad \text{for} \quad x_0 \leq x \leq x_1.$$

Indeed, since $F_{\tau_1}(u) < 0$ for $w_1(x_0) - \varepsilon \leq u_1 \leq w_1(x_0)$, $u_k = w_k(x_0)$ ($k = 2, \dots, n$), this is then also true by virtue of local monotonicity for $w_1(x_0) - \varepsilon \leq u_1 \leq w_1(x_0)$, $u_k \leq w_k(x_0)$ ($k = 2, \dots, n$). Relation (2.10) then follows from this and from the monotone decrease of $w(x)$. From (2.9) we obtain with the aid of (2.10),

$$a_{\tau_1}[w'_1(x_1) - w'_1(x_0)] > c[w_1(x_1) - w_1(x_0)] = c\varepsilon,$$

whence $c < (\|a_{\tau}\|/\varepsilon)|w'_1(x_0)|$. This, together with Lemma 2.1, yields a uniform estimate of the speed, since for arbitrary monotone solutions we can set $R = n^{1/2}$.

An estimate of the speed from below may be obtained similarly. Analogous constructions are carried out in a neighborhood of point p . This completes the proof of the theorem. \square

2.4. Behavior at infinity. In this section we consider the behavior of solutions of system (1.10) as $x \rightarrow \pm\infty$. The subscript τ will be omitted.

LEMMA 2.4. *Let $F(u_0) = 0$ and $F'(u_0) \in P$. If there exists a solution $w(x)$ of system (1.10) tending towards u_0 as $x \rightarrow \infty$ ($x \rightarrow -\infty$) and such that $w(x) > u_0$ for all sufficiently large x ($-x$), then there exist a number $\lambda \leq 0$ ($\lambda \geq 0$) and a positive vector q , such that*

$$[a\lambda^2 + c\lambda + F'(u_0)]q = 0.$$

PROOF. We limit the discussion to the case $x \rightarrow \infty$. The case $x \rightarrow -\infty$ is handled similarly.

We consider first the linear system (1.10), where

$$F(u) = B(u - u_0);$$

B is a square matrix with constant coefficients. Solution $w(x)$ has in this case the form

$$(2.11) \quad w(x) = (qx^s + \varphi(x)x^m)e^{\alpha x} + v(x) + u_0,$$

where the factor of the exponential term is not identically 0; s and m are nonnegative integers, $a \leq 0$,

$$(2.12) \quad (a\alpha^2 + c\alpha + B)q = 0;$$

$\varphi(x)$ is a linear combination of the functions $\cos \beta_j x$ and $\sin \beta_j x$, where β_j are the imaginary parts of the roots of the equation

$$\det(a\lambda^2 + c\lambda + B) = 0$$

with real part α ; $v(x)$ contains the lower terms.

We show first that $q \neq 0$. Indeed, in the contrary case,

$$(2.13) \quad (w(x) - u_0)e^{-\alpha x}x^{-m} = \varphi(x) + v(x)e^{-\alpha x}x^{-m}.$$

Since $\varphi(x)$ is an almost periodic function with mean value equal to 0, and the second term on the right-hand side of (2.13) tends towards zero, the right-hand side of (2.13) takes on negative values on some sequence $x_k \rightarrow \infty$, which contradicts the condition $w(x) > u_0$. Similarly, we may verify that $s \geq m$.

We show next that $q > 0$. Indeed, let us assume first that vector q has negative components. Assume, for example, that $q_1 < 0$. It then follows from (2.11) that $w_1(x) - u_{0_1}$ takes on negative values on some sequence $x_k \rightarrow \infty$ (when $s = m$

we need to take into account properties of function $\varphi(x)$. Thus, $q \geq 0$. Since $(a\alpha^2 + c\alpha + B) \in P$, it then follows from (2.12) that $q > 0$.

Thus, the lemma is proved in the linear case. Consider now the general case. Let B_ε be the matrix obtained from $F'(u_0)$ by subtracting the number $\varepsilon > 0$ from all of its elements. We consider ε so small that $B_\varepsilon \in P$. It is obvious that a $\delta > 0$ exists such that

$$F(u) > B_\varepsilon(u - u_0) \quad \text{for} \quad |u - u_0| \leq \delta, \quad u > u_0.$$

We select x_0 such that for $x \geq x_0$ we have $|w(x) - u_0| < \delta$. Then for $x \geq x_0$

$$(2.14) \quad aw'' + cw' + B_\varepsilon(w - u_0) = g(x),$$

where $g(x) = B_\varepsilon(w(x) - u_0) - F(w(x))$. Considering the boundary problem

$$\begin{aligned} \frac{\partial u}{\partial t} &= a \frac{\partial^2 u}{\partial x^2} + c \frac{\partial u}{\partial x} + B_\varepsilon(u - u_0), \\ u(x_0, t) &= w(x_0), \quad u(x, 0) = w(x) \end{aligned}$$

and taking note of (2.14), we readily show that there exists a vector-valued function $v(x)$ such that $v(x) > u_0$ for $x > x_0$, $v(x) \rightarrow u_0$ as $x \rightarrow \infty$, and

$$av'' + cv' + B_\varepsilon(v - u_0) = 0.$$

As has already been shown, it follows from this that a number $\lambda_\varepsilon \leq 0$ and a vector $q_\varepsilon > 0$ exist such that

$$(a\lambda_\varepsilon^2 + c\lambda_\varepsilon + B_\varepsilon)q_\varepsilon = 0,$$

where we can assume that $|q_\varepsilon| = 1$. We now let ε tend towards 0. We can assume that λ_ε converges to some λ and q_ε converges to some vector q . It is obvious that $\lambda \leq 0$ and $q \geq 0$. As was the case above, it follows from this that $q > 0$. This completes the proof of the lemma. \square

REMARK. If the maximum eigenvalue of matrix $F'(u_0)$ is not equal to 0, then, obviously, $\lambda \neq 0$.

LEMMA 2.5. *Let us assume that $F(u_0) = 0$, $F'(u_0) \in P$, and that at least one eigenvalue of this matrix is in the right half-plane. Then there cannot simultaneously exist two solutions $w_1(x)$ and $w_2(x)$ of system (1.10) such that $w_1(x) \rightarrow u_0$ as $x \rightarrow \infty$ and $w_1(x) > u_0$ for sufficiently large x , $w_2(x) \rightarrow u_0$ as $x \rightarrow -\infty$ and $w_2(x) < u_0$ for sufficiently large $-x$.*

PROOF. It follows from the preceding lemma that there exist numbers $\lambda_1 < 0$, $\lambda_2 < 0$ and positive vectors q_i , $i = 1, 2$, such that $T(\lambda_i)q_i = 0$, $i = 1, 2$, where $T(\lambda) = a\lambda^2 + c\lambda + F'(u_0)$. This means that when $\lambda = \lambda_i$ the eigenvalue with maximum real part of matrix $T(\lambda)$ is equal to 0. Since the maximum eigenvalue of matrix $T(0)$ is positive and, for $c \geq 0$, increases as λ increases, it follows that the equation $T(\lambda_2)q_2 = 0$ cannot hold. Similarly, when $c \leq 0$ the equation $T(\lambda_1)q_1 = 0$ cannot hold. This completes the proof of the lemma. \square

LEMMA 2.6. *Let $w(x)$ be a bounded solution of system (1.10), having limits as $x \rightarrow \pm\infty$. Further, let $w'_i(x) \neq 0$ for all x for some i , $1 \leq i \leq n$. Then for the i considered, the functions $w'_i(x)$ and $[w'_i(x)]^2$ are summable, and, for all x , either*

$$(2.15) \quad I_i^+(x) \equiv \int_x^\infty F_i(w)w'_i(x) dx > 0,$$

or

$$(2.16) \quad I_i^-(x) \equiv \int_{-\infty}^x F_i(w)w'_i(x) dx < 0,$$

and we also have the equality

$$(2.17) \quad \int_{-\infty}^\infty F_i(w)w'_i(x) dx = -c \int_{-\infty}^\infty [w'_i(x)]^2 dx.$$

PROOF. Summability of the functions $w'_i(x)$ and $[w'_i(x)]^2$ follows directly from the monotonicity and boundedness of $w_i(x)$. The remaining assertions may be obtained by multiplying the i th equation of system (1.10) by $w'_i(x)$ and integrating. This completes the proof of the lemma. \square

LEMMA 2.7. *Let $F(w)$ satisfy a condition of local monotonicity in some domain $G \in \mathbb{R}^n$, and let $w(x)$ be a solution of system (1.10), not identically equal to a constant. If for all values of x for which $w(x) \in G$ we have $w'(x) \leq 0$, then $w'(x) < 0$ for these x .*

In what follows, a more general result is required, of which Lemma 2.7 is a special case (see §2.7).

LEMMA 2.8. *Let $h(w)$ be a smooth vector-valued function, given for $w \in \mathbb{R}^n$, $h(0) = h(p) = 0$, where the matrices $h'(0)$ and $h'(p)$ belong to class P and have all their eigenvalues in the left half-plane. Further, let $F(w) = h(w)\omega(w)$, where $\omega(w)$ is defined by equation (2.1) and $\delta > 0$ is sufficiently small.*

Then if there exists a monotonically decreasing solution $w^{(1)}(x)$ of system (1.10) satisfying the conditions

$$\lim_{x \rightarrow \infty} w^{(1)}(x) = 0, \quad \lim_{x \rightarrow -\infty} w^{(1)}(x) = w_0^{(1)},$$

then $c < 0$. If there exists a monotonically decreasing solution $w^{(2)}(x)$ of system (1.10) satisfying the conditions

$$\lim_{x \rightarrow \infty} w^{(2)}(x) = p, \quad \lim_{x \rightarrow -\infty} w^{(2)}(x) = w_0^{(2)},$$

then $c > 0$. Here $w_0^{(i)}$ is an arbitrary point, different from 0 and p , at which $F(w_0^{(i)}) = 0$, $i = 1, 2$.

PROOF. We prove the first part of the lemma. The second is proved similarly.

Based on Lemma 2.3, we can select $\delta > 0$ so that for each w , $|w| = \delta$, $w \geq 0$, at least one of the functions $h_i(w)$ is negative. Assume, first, that $|w_0^{(1)}| = \delta$ and, for definiteness, that $h_1(w_0^{(1)}) < 0$. By the preceding lemma, $w_1^{(1)'}(x) < 0$, and we can use Lemma 2.6 for $i = 1$. Since condition (2.16) is not satisfied, then, for some $x = x_0$, $I_1^-(x_0) \geq 0$ and, for all x , $I_1^+(x) > 0$. It follows from this that $I_1^+(x_0) + I_1^-(x_0) > 0$ and that, by virtue of (2.17), $c < 0$.

Assume now that $|w_0^{(1)}| > \delta$. For those values of x for which $|w^{(1)}| \geq \delta$, the solution $w^{(1)}(x)$ can be found explicitly since $F(w(x)) = 0$ for these x . It follows from the explicit form of the solution that for some i we have $w_i^{(1)'}(x) \neq 0$ outside of a δ -neighborhood of the point 0. Inside the δ -neighborhood we have, from Lemma 2.7, $w_i^{(1)'}(x) < 0$. Thus, Lemma 2.6 is applicable also in this case, whence, as above, it follows that $c < 0$. This completes the proof of the lemma. \square

2.5. A priori estimates of solutions. We proceed now to obtaining directly a priori estimates of monotone solutions of system (1.10) with conditions (1.4).

LEMMA 2.9. *There exists a number ε , $0 < \varepsilon < \delta$, such that we have the following estimates of monotone solutions w_τ of problem (1.10), (1.4):*

$$|w_\tau(x)| \leq Ke^{-\alpha x}, \quad |w'_\tau(x)| \leq Ke^{-\alpha x}$$

for those values of x for which $|w_\tau(x)| \leq \varepsilon$, and

$$|w_\tau(x) - p| \leq Ke^{\beta x}, \quad |w_\tau(x)| \leq Ke^{\beta x}$$

for those values of x for which $|w_\tau(x) - p| \leq \varepsilon$. Moreover, the constants $K > 0$, $\alpha > 0$, $\beta > 0$ are independent of τ and of solution $w_\tau(x)$.

PROOF. Since $F'_\tau(w_\pm) \in P$ and the eigenvalues of these matrices have negative real parts, Condition 1.1 (see §1 of Chapter 2) is then satisfied with $b_\pm = F'_\tau(w_\pm)$. It follows from this that the roots of the equation

$$\det(a_\tau \lambda^2 + c\lambda + F'_\tau(w_\pm)) = 0$$

are separated from the imaginary axis for all $\tau \in [0, 1]$. The assertion of the lemma is a consequence of the Lyapunov-Perron theorem (see, for example, [Pli 1]). This completes the proof of the lemma. \square

LEMMA 2.10. *Let the conditions of Theorem 1.1 be satisfied. Then there exists a constant $\varkappa > 0$ such that outside of the ε -neighborhoods of the points 0 and p we have the estimate $|w'_{\tau_i}(x)| \geq \varkappa$ ($i = 1, \dots, n$) for an arbitrary monotone solution $w_\tau(x)$ of problem (1.10), (1.4). Here \varkappa is independent of τ and of solution $w_\tau(x)$; constant ε was defined in Lemma 2.9.*

PROOF. Let us assume that the assertion of the lemma does not hold. Then there exist sequences $\{\tau_k\}$, $\{w_{\tau_k}^k\}$, $\{x_k\}$ such that coordinate i_k of vector $w'_{\tau_k}(x_k)$ tends towards zero and the points $w_{\tau_k}^k(x_k)$ do not belong to ε -neighborhoods of points 0 and p . With no loss of generality, we can assume that $i_k = 1$, $\tau_k \rightarrow \tau_0$, and $c_k \rightarrow c_0$, where $\tau_0 \in [0, 1]$, c_0 is a constant, and c_k is the speed of the wave $w_{\tau_k}(x)$. Since solutions of system (1.10) are invariant relative to translation with respect to x , we can assume that $|w_{\tau_k}(0) - p| = \varepsilon$. We can also assume that the sequences $\{w_{\tau_k}^k(0)\}$ and $\{w_{\tau_k}^{k'}(0)\}$ are convergent with limits y and z , respectively. We denote by $v^{(1)}(x)$ the solution of system (1.10) for $c = c_0$, $\tau = \tau_0$ with initial conditions $v^{(1)}(0) = y$, $v^{(1)'}(0) = z$. It is clear that $v^{(1)}1(x) \rightarrow p$ as $x \rightarrow -\infty$.

We consider first the case where $v^{(1)}1(x) \rightarrow 0$ as $x \rightarrow \infty$. Then, outside of the ε -neighborhoods of the singular points, function $v^{(1)}(x)$ exists on a finite interval with respect to x . Since the solutions $w_{\tau_k}^k(x)$ converge to $v^{(1)}(x)$, then, for some $x = x_0$, the vector $v^{(1)'}(x_0)$ has zero components, and the point $v^{(1)}(x_0)$ lies outside the ε -neighborhoods of points 0 and p .

If $\tau_0 \in [0, 1/3]$ or $\tau_0 \in [2/3, 1]$, then the system is locally monotone and, since the derivative vanishes, we obtain a contradiction with Lemma 2.7, by virtue of the fact that $v^{(1)'} \leq 0$ for all x .

If $\tau_0 \in [1/3, 2/3]$, then in a domain where the source is identically equal to zero, $v(x)$ may be found explicitly and determines a line in \mathbb{R}^n along which $v_i^{(1)}(x) \equiv v_i^{(1)}(x_0)$, where i is the number of a component of vector $v^{(1)'}(x_0)$ that is equal to zero. Since this line cannot intersect simultaneously both ε -neighborhoods of points 0 and p (for $\varepsilon < 1/2$), we arrive at a contradiction.

Thus $v^{(1)}(x)$ is a monotone (not necessarily strict) vector-valued function, not tending towards 0, and embedded in the interval $[0, p]$. We denote by $w^{(1)}$ the limit of $v^{(1)}(x)$ as $x \rightarrow \infty$. In a similar way we may prove existence of function $v^{(2)}(x)$ having limit $w^{(2)} \neq p$ as $x \rightarrow -\infty$ and tending towards zero as $x \rightarrow \infty$. It is clear that $F_{\tau_0}(w^{(1)}) = F_{\tau_0}(w^{(2)}) = 0$. If $\tau_0 \in [1/3, 2/3]$, then this leads to a contradiction with Lemma 2.8. If τ_0 does not belong to this interval, the system is then locally monotone. For the case where $w^{(1)} = w^{(2)}$, this leads directly to a contradiction with Lemma 2.5. If $w^{(1)} \neq w^{(2)}$, then for the stationary point $w^{(1)}$, for example, we follow similar reasoning: we denote by $u^{(k)}$ and $\tilde{u}^{(k)}$ the values of the vector-valued functions $w_{\tau_k}^{(k)}(x)$ on the boundary of a small ε_1 -neighborhood of point $w^{(1)}$, and by $\omega^{(k)}$ and $\tilde{\omega}^{(k)}$ the corresponding values of their derivatives. Here $u^{(k)} > w^{(1)}$, $\tilde{u}^{(k)} < w^{(1)}$. We can assume that the sequences $\tilde{u}^{(k)}$ and $\tilde{\omega}^{(k)}$ are convergent, with their limits being denoted by \tilde{y} and \tilde{z} , respectively. We denote by $\tilde{v}(x)$ the solution of system (1.10) for $c = c_0$, $\tau = \tau_0$, satisfying the conditions $\tilde{v}(0) = \tilde{y}$, $\tilde{v}'(0) = \tilde{z}$. Function $\tilde{v}(x)$ is monotonically decreasing for all x and tends towards $w^{(1)}$ as $x \rightarrow -\infty$. Presence of the monotonically decreasing solutions $v(x)$ and $\tilde{v}(x)$ leads to a contradiction with Lemma 2.5, since the matrix $F'(w^{(1)})$ has eigenvalues in the right half-plane. \square

LEMMA 2.11. *Let \mathfrak{M}_r ($r \geq 0$) be the set of all monotone solutions $w(x)$ of problem (1.10), (1.4) for all $\tau \in [0, 1]$, such that the equality*

$$w_1(x_0) = 1/2$$

holds for $|x_0| \leq r$, where $w_1(x)$ is the first component of the vector-valued function $w(x)$. Then there exists a constant M_r such that for arbitrary $w \in \mathfrak{M}_r$

$$(2.18) \quad \|w - \psi\|_\mu \leq M_r.$$

PROOF. Let $w \in \mathfrak{M}_r$. Let x_1 and x_2 be points determined by the equation

$$|w(x_2)| = \varepsilon, \quad |p - w(x_1)| = \varepsilon,$$

where the constant $\varepsilon > 0$ was defined in Lemma 2.9. We assume that $\varepsilon < 1/2$, so that

$$(2.19) \quad x_1 < x_0 < x_2, \quad |x_0| \leq r.$$

Further, let \varkappa be the constant in the estimation of $w'(x)$ in Lemma 2.10. Then, obviously,

$$(2.20) \quad 0 < x_2 - x_1 < 1/\varkappa,$$

where we consider that $\varkappa < 1$. We have

$$(2.21) \quad \left(\int_{-1/\varkappa-r}^{1/\varkappa+r} |w - \psi|^2 \mu \, dx \right)^{1/2} \leq \left(n \int_{-1/\varkappa-r}^{1/\varkappa+r} \mu \, dx \right)^{1/2} + \left(\int_{-1/\varkappa-r}^{1/\varkappa+r} |\psi|^2 \mu \, dx \right)^{1/2}.$$

Further, it follows from (2.19), (2.20) that $1/\varkappa + r \geq x_2$, $1/\varkappa + r \geq -x_1$. Therefore, by virtue of the monotonicity of $w(x)$, we obtain $|w(x) - \psi(x)| \leq \varepsilon$ for $x \geq 1/\varkappa + r$ and for $x \leq -1/\varkappa - r$. From Lemma 2.9, inequality (2.21), and from the fact that growth of the function $\mu(x)$ is slower than exponential at infinity, we have the inequality

$$\left(\int_{-\infty}^{\infty} |w - \psi|^2 \mu(x) \, dx \right)^{1/2} \leq K_0$$

with constant K_0 being unique for the whole set \mathfrak{M}_r . In a similar way we establish the inequality

$$\left(\int_{-\infty}^{\infty} |w' - \psi'|^2 \mu(x) \, dx \right)^{1/2} \leq K_1,$$

where K_1 can also be chosen uniquely for all the functions from \mathfrak{M}_r . This completes the proof of the lemma. \square

PROOF OF THE FIRST PART OF PROPOSITION 1.2. Up to this point, we have considered speed c in system (1.10) as a constant. We now assume the speed to be a functional $c(u)$, where $u(x) = w(x) - \psi(x)$ and $w(x)$ is a monotone solution of system (1.10) with the conditions (1.4). We denote the solution of equation $w_1(x) = 1/2$ by x_0 and we prove that there exists an $r > 0$, such that $|x_0| < r$ for all monotone solutions of system (1.10) for all $\tau \in [0, 1]$. Let us assume the contrary. Then there exists a sequence $\{x_k\}$, $|x_k| \rightarrow \infty$, and a sequence of solutions $\{w^k(x)\}$ of system (1.10) in which $c = c(u^k)$, $u^k(x) = w^k(x) - \psi(x)$ are such that $w_1^k(x_k) = 1/2$.

Let

$$v^k(x) = w^k(x + x_k) - \psi(x),$$

so that $v^k + \psi \in \mathfrak{M}_0$ (see Lemma 2.11), and, thus, we have the estimate

$$(2.22) \quad \|v^k\|_\mu \leq M_0.$$

Further, we have (see (1.11) of Chapter 2)

$$(2.23) \quad \rho(u^k) = \left(\int_{-\infty}^{\infty} |v^k(x) + \psi(x)|^2 \sigma(x + x_k) \, dx \right)^{1/2}.$$

We show that $c(u^k)$ ($= \ln \rho(u^k)$) is unbounded, which leads to a contradiction with the a priori estimate of the speed obtained in §2.3. Actually, it follows from (2.22) that $\rho(u^k) \rightarrow \infty$ as $x_k \rightarrow \infty$. It also follows from (2.22) that $|v^k(x)| \leq N(\mu(x))^{-1/2}$ with constant N independent of k . Therefore, on the basis of Lemma 2.9, there exists a square-summable function $y(x)$ such that $|v^k(x)| \leq y(x)$. It follows from this and from (2.23) that $\rho(u^k) \rightarrow 0$ as $x_k \rightarrow -\infty$.

Thus we have shown that all monotone solutions of system (1.10) in which $c = c(u)$, with the conditions (1.4), belong to the set \mathfrak{M}_r for some $r > 0$. Validity of the first part of Proposition 1.2 follows from Lemma 2.11. \square

Let $A_\tau(u)$ be the operator introduced in §1 of Chapter 2 and corresponding to the problem (1.10), (1.4). Proposition 1.2 means that for all solutions $u(x)$ of the equation

$$(2.24) \quad A_\tau(u) = 0 \quad (u \in W_{2,\mu}^1, \quad \tau \in [0, 1]),$$

for which $u + \psi$ are monotone functions,

$$\|u\|_\mu \leq R,$$

where constant R is independent of the solution.

Henceforth, we shall use the notation

$$u_M = w_M - \psi, \quad u_N = w_N - \psi,$$

where w_M is a strictly monotone solution of problem (1.10), (1.4); w_N does not have this property.

In applying the Leray-Schauder method to proving the existence of solutions u_M of equation (2.24), we need to show that all the functions u_M and u_N are uniformly separated in the space $W_{2,\mu}^1$ and that we can determine a rotation of the field of operator $A_\tau(u)$ along boundaries of domains containing all solutions u_M and not containing u_N . These questions will be discussed in the following section.

2.6. Separation of monotone solutions.

PROOF OF THE SECOND PART OF PROPOSITION 1.2. Let us assume that the proposition is not true. We can then find sequences of solutions of equation (2.24): $\{u_{M,t_k}^{(k)}\}$ and $\{u_{N,t_k}^{(k)}\}$, for which

$$(2.25) \quad \|u_{M,t_k}^{(k)} - u_{N,t_k}^{(k)}\|_\mu \xrightarrow{k \rightarrow \infty} 0.$$

The vector-valued functions $w_{M,t_k}^{(k)}$ and $w_{N,t_k}^{(k)}$ are solutions of problem (1.10) and (1.4).

Since all the functions $u_{M,t_k}^{(k)}$ are in a ball of radius R of the space $W_{2,\mu}^1$, we can then assume that the sequence $\{u_{M,t_k}^{(k)}\}$ converges weakly to some $u_M^{(0)}$. We assume also that $t_k \rightarrow t_0$. Then (see §4, Chapter 2)

$$\langle A_{t_k}(u_{M,t_k}^{(k)}), S_{t_0}(u_{M,t_k}^{(k)} - u_M^{(0)}) \rangle \geq \|u_{M,t_k}^{(k)} - u_M^{(0)}\|_\mu + \varepsilon_k,$$

where $\varepsilon_k \rightarrow 0$ as $k \rightarrow \infty$. From this we have the strong convergence

$$\|u_{M,t_k}^{(k)} - u_M^{(0)}\|_\mu \xrightarrow{k \rightarrow \infty} 0$$

and the equality $A_{t_0}(u_M^{(0)}) = 0$. We let $w_0 = u_M^{(0)} + \psi$. Then w_0 is a solution of problem (1.10), (1.4) for $\tau = t_0$, $c = c(u_M^{(0)})$ and

$$(2.26) \quad \|w_{M,t_k}^{(k)} - w_0\|_\mu \rightarrow 0 \quad \text{as} \quad k \rightarrow \infty.$$

From (2.25) and (2.26) we have

$$(2.27) \quad \|w_{N,t_k}^{(k)} - w_0\|_\mu \rightarrow 0 \quad \text{as } k \rightarrow \infty.$$

From (2.26), (2.27) we have convergence in $C(-\infty, \infty)$ and, from the uniform boundedness of the functions $w_{M,t_k}^{(k)}$ and $w_{N,t_k}^{(k)}$ (see §2.2), convergence in $C^1(-\infty, \infty)$:

$$(2.28) \quad \sup_x |w_{M,t_k}^{(k)} - w_0(x)| + \sup_x |(w_{M,t_k}^{(k)}(x))' - w_0'(x)| \rightarrow 0,$$

$$(2.29) \quad \sup_x |w_{N,t_k}^{(k)} - w_0(x)| + \sup_x |(w_{N,t_k}^{(k)}(x))' - w_0'(x)| \rightarrow 0$$

as $k \rightarrow \infty$.

We show first that the vector-valued function w_0 is strictly monotone. Relation (2.28) implies nonstrict monotonicity, i.e., $w_0'(x) \leq 0$ for $-\infty < x < \infty$. Let us assume that for some $x = x_0$ at least one of the components of vector $w_0'(x_0)$ vanishes. If $t_0 \in [0, 1/3]$ or $t_0 \in (2/3, 1]$, then the vector-valued function $F_{t_0}(w)$ is locally monotone for $w \in \mathbb{R}^n$ and, by virtue of Lemma 2.7, $w_0(x) \equiv w_0(x_0)$, which contradicts (1.4). Now assume that $t_0 \in [1/3, 2/3]$. If $w_0(x)$ belongs to a δ -neighborhood of point 0 or p , we obtain a contradiction as in the case above, since in these neighborhoods the vector-valued function $F_{t_0}(w)$ is locally monotone. Let us assume that $w_0(x_0)$ lies on the boundary or outside of these neighborhoods. Since $F_{t_0}(w) \equiv 0$ for $|w| \geq \delta$, $|p - w| \geq \delta$, then outside of these neighborhoods $w_0(x)$ is a solution of the Cauchy problem

$$w'' + c(u_M^{(0)})w' = 0, \quad w(x_0) = w_0(x_0), \quad w'(x_0) = w_0'(x_0)$$

and can be readily found explicitly. From the explicit form of function $w_0(x)$ for $|w_0(x)| \geq \delta$, $|p - w_0(x)| \geq \delta$, we readily see that it determines a line in \mathbb{R}^n , passing through the point $w_0(x_0)$. Since vector $w_0'(x_0)$ has zero components, then, along this line, at least one coordinate stays constant, and it cannot intersect a δ -neighborhood of both points 0 and p , i.e., $w_0(x)$ cannot satisfy the conditions (1.4). The resulting contradiction shows that $w_0'(x) < 0$ for all x .

We now show that this leads to a contradiction with (2.29). Since the vector-valued functions $w_{N,\tau_k}^{(k)}$ are not strictly monotone, a point x_k can then be found at which the vector $(w_{N,\tau_k}^{(k)}(x))'$ has zero components. In the remaining part of the proof, for brevity, we write $w^{(k)} = w_{N,\tau_k}^{(k)}$. We can assume that $w_1^{(k)}(x_k) = 0$ and that $\tau_k \rightarrow \tau_0$. If the sequence $\{x_k\}$ is bounded, then, selecting a convergent subsequence, we find, for some $x = \tilde{x}$, that $w_1^{(k)}(\tilde{x}) = 0$, which contradicts what was proved above. We consider now the case in which this sequence is not bounded. We limit ourselves to the case $x_k \rightarrow \infty$.

Since $F_{\tau_0}'(0) \in P$, then $F_{\tau_0}'(0)q = \lambda q$, where q is a positive eigenvector and $\lambda < 0$ is the principal eigenvalue. We can therefore select $\varkappa > 0$ so small that for $|w| \leq \varkappa$, we have $F_{\tau_0}'(w) \in P$ and $F_{\tau_0}'(w)q < 0$, and we can select k_0 so large that

$$(2.30) \quad F_{\tau_k}'(w) \in P, \quad F_{\tau_k}'(w)q < 0 \quad \text{for } k \geq k_0, |w| \leq \varkappa.$$

We select x_* so that $|w_0(x)| < \varkappa$ for $x \geq x_*$, and $k_1 \geq k_0$ so that

$$|w^{(k_1)}(x)| < \varkappa \quad \text{for } x \geq x_*, w^{(k_1)'}(x_*) < 0 \text{ and } x_{k_1} > x_*.$$

The vector-valued function $w^{(k_1)'}(x)$ is a solution of the boundary problem

$$(2.31) \quad \begin{aligned} a_{\tau_{k_1}} v'' + cv' + F'_{\tau_{k_1}}(w^{(k_1)}(x))v &= 0, \\ v(x_*) &= w'_{k_1}(x_*), \quad v(\infty) = 0. \end{aligned}$$

We show that its solution for $x_* \leq x < \infty$ is strictly negative, which leads to a contradiction with the assumption $w^{(k_1)'}(x_{k_1}) = 0$, and concludes our proof of the proposition. Let us assume that the solution $v(x)$ of problem (2.31) is not negative for all $x \geq x_*$. Consider the vector-valued function $v_s(x) = v(x) - qs$. We can select $s = s_0$ so that $s_0 \geq 0$ and

$$v_{s_0}(x) \leq 0 \quad \text{for } x_* \leq x < \infty,$$

and, for some \tilde{x} , $x_* \leq \tilde{x} < \infty$, the vector $v_{s_0}(\tilde{x})$ has zero components. For definiteness, let $v_{s_{01}}(\tilde{x}) = 0$. Then $v_1(x) \leq q_1 s_0$ for $x_* \leq x < \infty$, $v_1(\tilde{x}) = q_1 s_0$. From this we have $v'_1(\tilde{x}) = 0$, $v''_1(\tilde{x}) \leq 0$. Let $s_0 > 0$. We show that

$$(2.32) \quad \sum_{i=1}^n \frac{\partial F_{\tau_{k_1,1}}(w^{(k_1)}(\tilde{x}))}{\partial w_i} v_i(\tilde{x}) < 0.$$

To do this, we consider the function

$$\varphi(\xi) = \sum_{i=1}^n \frac{\partial F_{\tau_{k_1,1}}(w^{(k_1)}(\tilde{x}))}{\partial w_i} (q_i s_0 \xi + v_i(\tilde{x})(1 - \xi)).$$

If $q s_0 = v(\tilde{x})$, then (2.32) follows from (2.30). If $q s_0 \neq v(\tilde{x})$, then $\varphi'(\xi) > 0$, $\varphi(1) < 0$; consequently, $\varphi(0) < 0$. This establishes inequality (2.32). It contradicts the first equation of the system (2.31). Let $s_0 = 0$. If $v(\tilde{x}) \neq 0$, then, as above, we obtain a contradiction with (2.31). If $v(\tilde{x}) = 0$, then $v'(\tilde{x}) = 0$, whence $v(x) \equiv 0$, which contradicts the boundary condition in (2.31). Thus, negativity of the solution of problem (2.31) has been proved. This completes the proof of the proposition. \square

We consider a ball $\|u\|_\mu \leq R$ of space $W_{2,\mu}^1$ in which all solutions u_M of equation (2.24) are contained. We set $R_1 = R + 1$ and we select r , $0 < r < 1$, such that for all solutions of equation (2.24) in the ball $\|u\|_\mu \leq R_1$ we have the inequality $\|u_{M,\tau_1} - u_{N,\tau_2}\|_\mu > r$, $\tau_1, \tau_2 \in [0, 1]$. We fix a value of parameter τ and construct the ball $K_\tau(u_{M,\tau})$ of radius r and center at the point $u_{M,\tau}$. By virtue of compactness of the set of solutions $u_{M,\tau}$, we can select from a covering of this set by balls K_τ a finite subcovering. We denote by $G_k(\tau)$, $k = 1, \dots, N(\tau)$, the set of domains formed by the union of the balls from this subcovering; $\Gamma_k(\tau)$, $k = 1, \dots, N(\tau)$, are the boundaries of these domains.

It is obvious that for arbitrary $\tau = \tau_0$, $u_{N,\tau_0} \notin \bigcup_{k=1}^{N(\tau_0)} [G_k(\tau_0) + \Gamma_k(\tau_0)]$ and all solutions u_{M,τ_0} belong to $\bigcup_{k=1}^{N(\tau_0)} G_k(\tau_0)$. We show that for all τ from some neighborhood $\Delta(\tau_0)$ of the point τ_0

$$(2.33) \quad u_{M,\tau} \in \bigcup_{k=1}^{N(\tau_0)} G_k(\tau_0) \quad \forall u_{M,\tau},$$

$$(2.34) \quad u_{N,\tau} \notin \bigcup_{k=1}^{N(\tau_0)} [G_k(\tau_0) + \Gamma_k(\tau_0)].$$

Actually, if (2.33) does not hold, we can then find sequences $\{\tau_j\}$, $\tau_j \rightarrow \tau_0$, and

$\{u_{M,\tau_j}^{(j)}\}$, such that $u_{M,\tau}^{(j)} \notin \bigcup_{k=1}^{N(\tau_0)} G_k(\tau_0)$. We can assume that $u_{M,\tau_j}^{(j)}$ converges weakly to some u_0 . From the inequality

$$\langle A_{\tau_j}(u_{M,\tau_j}^{(j)}), S_{t_0}(u_{M,\tau_j}^{(j)} - u_M^{(0)}) \rangle \geq \|u_{M,\tau_j}^{(j)} - u_0\|_\mu + \varepsilon_j,$$

where $\varepsilon_j \rightarrow 0$, we have the strong convergence $\|u_{M,\tau_j}^{(j)} - u_0\|_\mu \rightarrow 0$. It follows from this that $A_{\tau_0}(u_0) = 0$, $u_0 \notin \bigcup_{k=1}^{N(\tau_0)} G_k(\tau_0)$, and $u_0 + \psi$ is a strict monotone solution of problem (1.10), (1.4). The resulting contradiction establishes (2.33). We prove (2.34) similarly.

THEOREM 2.2. *Let*

$$\gamma(\tau) = \sum_{k=1}^{N(\tau)} \gamma(A_\tau, \Gamma_k(\tau)), \quad \tau \in [0, 1],$$

where $\gamma(A_\tau, \Gamma_k(\tau))$ is a rotation of the field of operator A_k along the boundary $\Gamma_k(\tau)$. Then $\gamma(0) = \gamma(1)$.

PROOF. According to the construction of domains $G_k(\tau)$ given above, the degree $\gamma(A_{\tau_0}, \Gamma_k(\tau_0))$ is defined for arbitrary $\tau_0 \in [0, 1]$. From what was proved earlier, the degree $\gamma(A_{\tau_1}, \Gamma_k(\tau_0))$ is also defined for arbitrary $\tau_1 \in \Delta(\tau_0)$, a neighborhood of point τ_0 . Therefore,

$$(2.35) \quad \sum_{k=1}^{N(\tau_0)} \gamma(A_{\tau_1}, \Gamma_k(\tau_0)) = \sum_{k=1}^{N(\tau_0)} \gamma(A_{\tau_0}, \Gamma_k(\tau_0)).$$

On the other hand, for arbitrary solutions of equation (2.24), for $\tau = \tau_1$ we have

$$\begin{aligned} u_{M,\tau_1} &\in \left(\bigcup_{k=1}^{N(\tau_0)} G_k(\tau_0) \right) \cap \left(\bigcup_{k=1}^{N(\tau_1)} G_k(\tau_1) \right), \\ u_{N,\tau_1} &\notin \left(\bigcup_{k=1}^{N(\tau_0)} [G_k(\tau_0) + \Gamma_k(\tau_0)] \right) \cup \left(\bigcup_{k=1}^{N(\tau_1)} [G_k(\tau_1) + \Gamma_k(\tau_1)] \right), \end{aligned}$$

whence

$$\sum_{k=1}^{N(\tau_0)} \gamma(A_{\tau_1}, \Gamma_k(\tau_0)) = \sum_{k=1}^{N(\tau_1)} \gamma(A_{\tau_1}, \Gamma_k(\tau_1)), \quad \forall \tau_1 \in \Delta(\tau_0).$$

It follows from this equation and (2.35) that $\gamma(\tau_0) = \gamma(\tau_1)$ for arbitrary $\tau_1 \in \Delta(\tau_0)$. The assertion of the theorem readily follows from this. This completes the proof of the theorem. \square

2.7. LEMMA CONCERNING MONOTONICITY OF SOLUTIONS. *We consider the system*

$$(2.36) \quad au'' + cu' + F(u) = 0,$$

where a and c are diagonal matrices of order n , matrix a has positive diagonal elements, and the vector-valued function F ($F = (F_1, \dots, F_n)$) satisfies the following conditions generalizing the condition of local monotonicity:

For each u^0 belonging to the domain of definition of function F and satisfying condition $F_i(u^0) = 0$, there exists a constant k such that

$$(2.37) \quad \begin{aligned} F_i(u) &\leq k(u_i^0 - u_i) & \text{for } u \leq u^0, \\ F_i(u) &\geq k(u_i^0 - u_i) & \text{for } u \geq u^0 \end{aligned}$$

in some neighborhood of the point u^0 ($i = 1, \dots, n$).

Let $u(x) = (u_1(x), \dots, u_n(x))$ be a nonincreasing solution of system (2.36) over the whole x -axis, belonging to the domain of definition of function F for all x . Then $u_i(x)$, $i = 1, \dots, n$, is either identically a constant or has a negative derivative for all x .

PROOF. Suppose $u_i(x)$ is not identically equal to a constant and $u_i'(x_0) = 0$ at some point x_0 . Then $u_i''(x_0) = 0$ and, at an arbitrary sufficiently small right (left) half-neighborhood of point x_0 , the function $u_i(x)$ is not identically a constant. It follows from (2.36) that

$$(2.38) \quad a_i u_i'' + c_i u_i' + F_i(u) = 0,$$

where a_i and c_i are diagonal elements of the corresponding matrices and $F_i(u(x_0)) = 0$. Let $u^0 = u(x_0)$. For definiteness we consider the case of a right half-neighborhood. Equation (2.38) can be written in the form

$$a_i u_i'' + c_i u_i' + k(u_i^0 - u_i) = g(x),$$

where $g(x) = k(u_i^0 - u_i(x)) - F_i(u(x)) \geq 0$ in some neighborhood of point x_0 for $x > x_0$, by virtue of condition (2.37). We set $v(x) = u_i(x) - u_i(x_0)$. We obtain

$$(2.39) \quad a_i v'' + c_i v' - kv = g(x), \quad v(x_0) = 0, \quad v'(x_0) = 0.$$

Let $x_1 > x_0$ and $x_1 - x_0$ be sufficiently small. Let $w(x) = (x - x_1)^2$. Then, multiplying equation (2.39) by $w(x)$ and integrating from x_0 to x_1 , we obtain, after an integration by parts,

$$(2.40) \quad \int_{x_0}^{x_1} [2a_i - 2c_i(x - x_1) - k(x - x_1)^2]v(x) dx = \int_{x_0}^{x_1} g(x)w(x) dx.$$

We take x_1 so small that the expression in square brackets is positive. Then, since $v(x) \leq 0$ and is not identically equal to zero on the interval $[x_0, x_1]$, we obtain a contradiction in signs in equation (2.40). This completes the proof of the lemma. □

§3. Existence of monotone waves

3.1. Index of a stationary point. To determine the index of a stationary point we need the following lemma, a consequence of Proposition 1.3.

LEMMA 3.1. *Let the operator*

$$(3.1) \quad L_1 u = Lu + \varphi(u)w$$

be given, where operator L and the vector-valued function w are as defined in Proposition 1.3, and

$$\varphi(u) = \int_{-\infty}^{\infty} (u(x), g(x)) dx,$$

$g(x)$ is a real continuous vector-valued function from $L^2(-\infty, \infty)$, $\varphi(w) < 0$. Then the equation

$$(3.2) \quad L_1 u = \lambda u, \quad u(\pm\infty) = 0$$

has no solutions different from zero with $\operatorname{Re} \lambda \geq 0$.

PROOF. Suppose that there exists a nonzero solution of equation (3.1) with $\operatorname{Re} \lambda \geq 0$. Since the matrices $B_{\pm} - \xi a^2 - \lambda E$ have eigenvalues in the left half-plane for all real ξ and $\operatorname{Re} \lambda \geq 0$, the operator $L_1 - \lambda E$ has the Fredholm property in $L^2(-\infty, \infty)$ (see [Vol 10, 12] and Chapter 4). Therefore there exists a nonzero solution v of the adjoint equation

$$(3.3) \quad L^* v + g\varphi_1(v) = \bar{\lambda}v,$$

where

$$\varphi_1(v) = \int_{-\infty}^{\infty} (v, w) dx.$$

Taking the inner product of (3.3) with w , we obtain $\varphi(w)\varphi_1(v) = \bar{\lambda}\varphi_1(v)$. Since $\varphi(w) < 0$, then $\varphi_1(v) = 0$ and, by virtue of (3.3), λ is an eigenvalue of operator L . On the basis of the condition of the lemma, $\lambda = 0$. Therefore v is an eigenfunction of operator L^* corresponding to a zero eigenvalue. By virtue of the positiveness of w and v (to within a factor), this contradicts the equation $\varphi_1(v) = 0$. This completes the proof of the lemma. \square

THEOREM 3.1. *Let system (1.3) be monotone and let u_0 be a stationary point of the corresponding operator $A(u)$. Then if the vector-valued function $w_0(x) = u_0(x) + \psi(x)$ is monotone, the equation*

$$A'(u_0)u = 0 \quad (u \in E)$$

has no solutions different from zero and the index of the stationary point u_0 is equal to 1.

PROOF. By virtue of the properties of smoothness of generalized solutions, the function $w_0(x)$ is a solution of equation (1.3). Differentiating (1.3), we obtain the result that $w(x) = -w'_0(x)$ is a positive solution of equation (1.13), where $B(x) = F'(w_0(x))$, and satisfies the conditions of §1. Let $\lambda \leq 0$ and let u be a solution of equation (1.14). Then the function $u(x)$ is a solution of the equation

$$L_1 u = -\lambda u,$$

where L_1 is the operator (3.1), in which, by virtue of the representation for $c'(u_0)$, we have $g(x) = -\rho^{-2}w_0(x)\sigma(x)$ (c' and ρ are defined in §1 of Chapter 2). It may be verified directly that $\varphi(w) < 0$. We therefore conclude from Lemma 3.1 that $u = 0$. Hence, values of $\lambda \leq 0$ cannot be eigenvalues of operator A_* . The theorem then

follows from this and from Theorem 1.5 of Chapter 2. This completes the proof of the theorem. \square

3.2. Model system. In §1 a model system was presented. We now establish the required properties for this system.

LEMMA 3.2. *To each solution $v(x)$ of the equation*

$$(3.4) \quad v'' + cv' + g_1(v, \dots, v) = 0, \quad v(-\infty) = 1, \quad v(\infty) = 0,$$

there corresponds a solution

$$(3.5) \quad w(x) = (v(x), \dots, v(x))$$

of problem (1.8), (1.4), and each solution of this problem has the form (3.5), where function $v(x)$ satisfies equation (3.4).

PROOF. If function $v(x)$ satisfies (3.4), then, obviously, the vector-valued function (3.5) satisfies (1.8), (1.4). Conversely, let the vector-valued function $w(x)$ satisfy (1.8), (1.4). We show that $w_i(x) \equiv w_1(x)$, $i = 2, \dots, n$. Indeed, let us set $z(x) = w_1(x) - w_i(x)$ and subtract the i th equation of system (1.8) from the first. Then

$$z'' + cz' + (a_1(x) - a_2(x))z = 0, \quad z(\pm\infty) = 0,$$

where

$$\begin{aligned} a_1(x) &= [g_1(w_1, w_2, \dots, w_{i-1}, w_1, w_{i+1}, \dots, w_n) \\ &\quad - g_1(w_i, w_2, \dots, w_{i-1}, w_1, w_{i+1}, \dots, w_n)] / (w_1 - w_i), \\ a_2(x) &= [g_1(w_1, w_2, \dots, w_{i-1}, w_1, w_{i+1}, \dots, w_n) \\ &\quad - g_1(w_1, w_2, \dots, w_{i-1}, w_i, w_{i+1}, \dots, w_n)] / (w_1 - w_i). \end{aligned}$$

It is easy to see that $a_1(x) < 0$, $a_2(x) > 0$ for all x . Hence it follows that $z(x) \equiv 0$.

Thus, an arbitrary solution of system (1.8) with the conditions (1.4) has the form (3.5), where $v(x) \equiv w_1(x)$. Function $v(x)$ satisfies (3.4). This completes the proof of the lemma. \square

It is known that under the assumptions made in §1 on the function $g_1(w_1, \dots, w_1)$ the equation (3.4) has exactly one monotone solution [Fife 7, Kan 3]. Therefore, it follows from Lemma 3.2 that a monotone solution $w(x)$ of problem (1.8), (1.4) exists and is unique. The vector-valued function $u(x) = w(x) - \psi(x)$ is a stationary point of operator $A(u)$ corresponding to this problem. By Theorem 3.1, the index of this stationary point is equal to 1.

3.3. Existence of waves. We prove the existence of monotone solutions for locally monotone systems and their uniqueness in the case of monotone systems.

PROOF OF THEOREM 1.1. With no loss of generality, we can assume that $w_+ = 0$, $w_- = p$. Consider the homotopy (2.3), (2.4). By virtue of the a priori estimates of §2, we can use Theorem 2.2. As shown in §3.2, rotation of the field of operator $A_\tau(u)$, corresponding to system (1.10), is equal to 1 for $\tau = 1$. Consequently, rotation of the field of operator $A_0(u)$, corresponding to the initial system, is also equal to 1, whence existence of a solution follows.

If system (1.3) is monotone, then uniqueness of a monotone wave follows from Theorem 3.1. The theorem is thereby proved. \square

In conclusion we dwell briefly on the question concerning the existence of systems of waves when there are stable zeros p_1, \dots, p_s of the vector-valued function $F(u)$ in the interval (w_+, w_-) . As was mentioned in §1, we can select points p_{i_1}, \dots, p_{i_r} satisfying (1.9). Indeed, we select point p_{j_1} arbitrarily from p_1, \dots, p_s . If there are points p_1, \dots, p_s in the interval (w_+, p_{j_1}) (none of them can be on the boundary of the interval by virtue of Lemma 2.2), we then select one of them, p_{j_2} , arbitrarily and consider the intervals (w_+, p_{j_1}) and (p_{j_2}, p_{j_1}) . Continuing this process, we obtain a set of points p_{j_1}, \dots, p_{j_2} , which, after renumbering, satisfy (1.9); moreover, the intervals $(w_+, p_{i_1}), \dots, (p_{i_r}, w_-)$ will not contain the points p_1, \dots, p_s . Since in these constructions the first point is selected arbitrarily, then for an arbitrary point from p_1, \dots, p_s we can find a set of points satisfying (1.9) and, consequently, a system of waves corresponding to this set.

REMARK. The existence of waves was proved assuming inequality (1.6) to be strict. However, in some applications, for example, in chemical kinetics, these inequalities turn out to be nonstrict. We now present a theorem for existence of a wave assuming inequality (1.6) to be nonstrict in some neighborhood.

THEOREM 3.2. *Let the vector-valued function $F(w)$ vanish at a finite number of points in the interval $[w_+, w_-]$: $w_+, w_-, w_1, \dots, w_m$. We assume that all the eigenvalues of the matrices $F'(w_+)$ and $F'(w_-)$ lie in the left half-plane and that there exist vectors $p_k \geq 0$ such that $p_k F'(w_k) > 0$, $k = 1, \dots, m$. Then there exists a monotone traveling wave, i.e., a constant c and a twice continuously differentiable vector-valued function $w(x)$, monotonically decreasing, satisfying system (1.3) and the conditions (1.4).*

The proof of this theorem is obtained from an already studied case by passing to a limit. Moreover, in the analysis in a neighborhood of the points w_k , use is made of a lemma concerned with signs of the speed, which we present in §4.

We remark that from a condition of the theorem it follows that the matrix $F'(w_k)$ has at least one eigenvalue in the right half-plane. If this matrix is irreducible, then, as is well known, the converse statement is valid: if the principal eigenvalue is found in the right half-plane, then the indicated vector p_k exists.

§4. Monotone systems

In the preceding section monotone systems were considered as a special case of locally monotone systems. However, more complete results can be obtained for monotone systems. Several of the latter will be discussed in this section (see also Chapters 4, 5).

Results related to the existence of waves depend on the character of the stationary points w_+ and w_- of the system

$$(4.1) \quad \frac{du}{dt} = F(u).$$

Obviously, only the following cases are possible:

- I. Both of the stationary points w_+ and w_- of system (4.1) are stable (bistable case);
- II. One of the points w_+ or w_- is stable, the other unstable (monostable case);

III. Both of the points w_+ and w_- are unstable (unstable case).

The bistable case was studied in the preceding section. Here we consider two other cases.

4.1. Unstable case. In this section we shall not assume that the system (1.1) is monotone. We consider the problem concerning the sign of the speed c and, as a consequence, we find that in Case III waves do not exist (a precise statement is given below).

We begin with the following definitions. We say that vector-valued function $F(u)$ satisfies a condition of positiveness in a positive neighborhood of point u_0 if a vector $p \geq 0$ exists such that

$$(p, F(u) - F(u_0)) > 0$$

for all $u \geq u_0$, $u \neq u_0$ in some neighborhood of point u_0 . Similarly, the vector-valued function $F(u)$ satisfies a condition of negativeness in a negative neighborhood of point u_0 if there exists a vector $p \geq 0$ such that

$$(p, F(u) - F(u_0)) < 0$$

for all $u \leq u_0$, $u \neq u_0$ in some neighborhood of point u_0 . It is obvious that if a vector $p \geq 0$ exists such that $pF'(u_0) > 0$, then the function $F(u)$ satisfies the condition of positiveness in a positive neighborhood of point u_0 and the condition of negativeness in a negative neighborhood of point u_0 .

LEMMA 4.1. *Let us assume that a monotonically decreasing solution of system (1.3) exists and that the conditions (1.4) and (1.5) are satisfied. Then if $F(u)$ satisfies a condition of positiveness in a positive neighborhood of point w_+ , it follows that $c > 0$. If $F(u)$ satisfies a condition of negativeness in a negative neighborhood of point w_- , then $c < 0$.*

PROOF. We prove the assertion for point w_+ . For w_- the proof is similar. Let $y(x) = w(x) - w_+$. Then $y(x) \geq 0$, $y'(x) \leq 0$,

$$(4.2) \quad ay'' + cy' + F(w) = 0.$$

Let p be a vector appearing in the definition of the condition of positiveness of function $F(u)$ in a positive neighborhood of point w_+ . Then, obviously,

$$pF(w(x)) > 0$$

for $x > x_0$ providing x_0 is sufficiently large. We multiply (4.2) by p and integrate from x_0 to x_1 ($x_1 > x_0$):

$$(4.3) \quad pay'(x_1) - pay'(x_0) + cpy(x_1) - cpy(x_0) + \int_{x_0}^{x_1} pF(w(x)) dx = 0.$$

In view of the boundedness of $y(x)$ and $y'(x)$, we conclude that there exists a finite limit of the integral as $x_1 \rightarrow \infty$. Since the limit of $y(x)$ as $x \rightarrow \infty$ exists, it follows

from (4.3) that the limit of $pay'(x)$ as $x \rightarrow \infty$ exists; this limit is obviously equal to zero. Letting $x_1 \rightarrow \infty$ in (4.3), we obtain

$$-pay'(x_0) - cpy(x_0) + \int_{x_0}^{\infty} pF(w(x)) dx = 0.$$

Since the integral is positive, and $y(x_0) \geq 0, y'(x_0) \leq 0$, then $c > 0$. This completes the proof of the lemma. □

An immediate consequence of this lemma is the following theorem.

THEOREM 4.1. *If the vector-valued function $F(u)$ satisfies the condition of positiveness in a positive neighborhood of point w_+ and the condition of negativeness in a negative neighborhood of point w_- , then a monotone wave solution does not exist, i.e., there is no solution of system (1.3) with the condition (1.4).*

PROOF. If a solution did exist, there would be a contradiction in signs of the speed. The theorem is thereby proved. □

We note, in particular, that if there exist vectors $p \geq 0$ and $q \geq 0$ such that $pF'(w_+) > 0$ and $qF'(w_-) > 0$, then the conditions of the theorem are satisfied and, consequently, a monotone wave does not exist.

In proceeding, we shall be interested in the case where matrices $F'(w_+)$ and $F'(w_-)$ have nonnegative off-diagonal elements. Then if their principal eigenvalues are positive and the matrices are irreducible, the indicated vectors p and q exist. As such vectors we can take the corresponding eigenvectors. However, the condition of irreducibility of a matrix can be a condition that is too restricting in certain applications. Such conditions can be weakened. For example, for a reducible matrix in its block-triangle representation we can assume that all the diagonal blocks have positive eigenvalues.

4.2. Monostable case. Here, and in what follows, we assume that system (1.1) is monotone.

To formulate a theorem for existence of a wave we need to introduce a functional ω^* ; with the aid of this functional we may calculate the minimum speed of a wave. Let K be the class of vector-valued functions $\rho(x) \in C^2(-\infty, \infty)$, decreasing monotonically and satisfying conditions at $\pm\infty$:

$$\lim_{x \rightarrow \pm\infty} \rho(x) = w_{\pm}.$$

We set

$$(4.4) \quad \psi^*(\rho) = \sup_{x,k} \frac{a_k \rho_k''(x) + F_k(\rho(x))}{-\rho_k'(x)},$$

$$(4.5) \quad \omega^* = \inf_{\rho \in K} \psi^*(\rho).$$

Here a_k and F_k are the diagonal elements of matrix a and the elements of vector F appearing in system (1.1).

THEOREM 4.2. *Assume that vector $p \geq 0, p \neq 0$, exists such that*

$$(4.6) \quad F(w_+ + sp) \geq 0 \quad \text{for} \quad 0 < s \leq s_0,$$

where s_0 is a positive number. Assume further that in the interval $[w_+, w_-]$ (i.e., for $w_+ \leq w \leq w_-$) the vector-valued function $F(w)$ vanishes only at the points w_+

and w_- . Then for all $c \geq \omega^*$ there exists a monotonically decreasing solution of system (1.3) satisfying the conditions (1.4). When $c < \omega^*$, such solutions do not exist.

PROOF. We assume first that $c > \omega^*$. Then $\rho(x) \in K$ exists such that $\psi^*(\rho) < c$. On the basis of (4.4) this means that

$$(4.7) \quad a\rho''(x) + c\rho'(x) + F(\rho(x)) < 0$$

for all x .

Let $b > 0$ be some number. We select number s , $0 < s < s_0$, such that

$$(4.8) \quad sp < \rho(b) - w_+.$$

This is possible since $\rho(b) > w_+$.

Consider now a boundary problem for system (1.3) on semi-axis $x < b$ with the condition

$$(4.9) \quad w(b) = sp + w_+.$$

We show that there exists a monotonically increasing solution of this problem. To do this, we consider the problem

$$(4.10) \quad \begin{aligned} \frac{\partial u}{\partial t} &= a \frac{\partial^2 u}{\partial x^2} + c \frac{\partial u}{\partial x} + F(u), & t > 0, \quad x < b, \\ u(b, t) &= w(b), & u(x, 0) &= w(b). \end{aligned}$$

On the basis of (4.6) and (4.9), we have $F(w(b)) \geq 0$. Therefore, the function-constant $u = w(b)$ is a lower function for system (4.10). Consequently, a solution of this system is monotonically increasing with respect to t .

On the other hand, it follows from (4.9) and (4.8) that $\rho(b) > w(b)$. Therefore, on the basis of (4.7) we can conclude that $\rho(x)$ is an upper function for problem (4.10), so that $u(x, t) \leq \rho(x)$ for $x < b, t > 0$. Thus the limit of $u(x, t)$ as $t \rightarrow \infty$ exists; we denote it by $w(x)$, where, obviously,

$$(4.11) \quad w(x) \leq \rho(x).$$

It is easy to see that $w(x)$ is a solution of system (1.3) for $x < b$, satisfying condition (4.9). Indeed, based on a priori estimates of solutions of problem (4.10), we conclude, by virtue of the boundedness of $u(x, t)$, that the derivatives $u'_x(x, t)$ are bounded. Therefore the convergence $u(x, t) \rightarrow w(x)$ is uniform on each bounded interval of the form $[x_0, b]$, so that $w(x)$ is a continuous function and condition (4.9) is satisfied. In order to show that $w(x)$ is a solution of system (1.3) for an arbitrary function $\varphi(x)$ with support on the semi-axis $x < b$, we set

$$\begin{aligned} \bar{u}(t) &= \int u(x, t)\varphi(x) dx, \\ f(t) &= \int [a\varphi''(x)u(x, t) - c\varphi'(x)u(x, t) + \varphi(x)F(u(x, t))] dx \end{aligned}$$

(integration is taken over the whole axis). Then

$$\bar{u}'(x) = f(t)$$

and

$$\bar{u}(t+1) - \bar{u}(t) = \int_0^1 f(s+t) ds.$$

As $t \rightarrow \infty$, we obtain

$$\int [a\varphi''(x)w(x) - c\varphi'(x)w(x) + \varphi(x)F(w(x))] dx = 0.$$

Thus, $w(x)$ is a generalized solution of equation (1.3) and therefore an ordinary solution.

We show that $w(x)$ is monotonically nonincreasing. To do this, we return to problem (4.10) and let $y(x, t) = u'_x(x, t)$. We have

$$(4.12) \quad \begin{aligned} \frac{\partial y}{\partial t} &= a \frac{\partial^2 y}{\partial x^2} + c \frac{\partial y}{\partial x} + F'(u(x, t))y, \\ y|_{t=0} &= 0, \quad y|_{x=b} \leq 0. \end{aligned}$$

The last inequality follows from the fact that $u(x, t) \geq w(b)$ for $x < b$, $u(b, t) = w(b)$. Consequently, $y(x, t) \leq 0$. Thus we have shown that $u(x, t)$ is monotonically nonincreasing with respect to x . It is obvious that $w(x)$ also possesses this property.

We now estimate $w'(x)$. Let β be an arbitrary number, $\beta \leq b$, $\alpha = \beta - 1$. We set $y_k(x) = w_k(\alpha)(\beta - x) + w_k(\beta)(x - \alpha)$, $k = 1, \dots, n$, where $w = (w_1, \dots, w_n)$, $v_k = w_k - y_k$. Then from (1.3) we have

$$(4.13) \quad a_k v_k''(x) + c w_k'(x) + F_k(w(x)) = 0.$$

Since $v_k(\alpha) = v_k(\beta) = 0$, then $v_k'(x_k) = 0$ at some point $x_k \in (\alpha, \beta)$. Integrating (4.13), we obtain, for $x \in [\alpha, \beta]$,

$$a_k v_k'(x) + c w_k(x) - c w_k(x_k) + \int_{x_k}^x F_k(w(s)) ds = 0.$$

Hence

$$a_k |v_k'(x)| \leq 2|c| \sup |w_k(x)| + \sup |F_k(w(x))|,$$

where sup is taken over $x \in [\alpha, \beta]$. Further,

$$|w_k'(x)| \leq |v_k'(x)| + |y_k'(x)| \leq |v_k'(x)| + |w_k(\alpha)| + |w_k(\beta)|,$$

whence

$$a_k |w_k'(x)| \leq 2(|c| + a_k) \sup |w_k(x)| + \sup |F_k(w(x))|.$$

Noting that $w \in [w_+, w_-]$, we obtain

$$(4.14) \quad a_k |w_k'(x)| \leq 2(|c| + a_k) \sup w_{-k} + \sup_{w \in [w_+, w_-]} |F_k(w(x))|,$$

where w_{-k} is the k th element of vector w_- . It is clear that the estimate holds for all $x \leq b$ and, moreover, does not depend on b , a fact which we shall use in what follows.

Let $\bar{w} = \lim_{x \rightarrow -\infty} w(x)$. We show that

$$(4.15) \quad F(\bar{w}) = 0.$$

Indeed, letting

$$(4.16) \quad p(x) = w'(x),$$

from (1.3) we obtain

$$(4.17) \quad ap' + cp + F(w) = 0,$$

and we consider system (4.16), (4.17) with respect to (w, p) . The α -limit set of solution $(w(x), p(x))$ is also a solution of this system, which we denote by $(\bar{w}, \bar{p}(x))$, where \bar{w} is a constant, so that $\bar{p} \equiv 0$, and we obtain (4.15) from (4.17).

Since $\bar{w} \neq w_+$, it then follows from the assumptions of the theorem that $\bar{w} = w_-$. Thus we have shown that

$$\lim w(x) = w_- \quad \text{as } x \rightarrow -\infty.$$

It follows from (4.11) that $w_1(0) \leq \rho_1(0)$ (subscript 1 indicates the first element of a vector). We select number x_0 such that

$$w_1(x_0) = \rho_1(x_0).$$

Obviously, $x_0 \leq 0$. We consider the shifted function $w^b = w(x + x_0)$. This function possesses the following properties: it is a solution of system (1.3) on the semi-axis $x < b$, $w^b(x) \in [w_+, w_-]$, it is monotonically nonincreasing,

$$\lim w^b(x) = w_- \quad \text{as } x \rightarrow -\infty,$$

and

$$w_1^b(0) = \rho_1(0).$$

It follows from the estimate (4.14) that $w^{b'}(x)$ is uniformly bounded with respect to $x \leq b$ and b . We shall consider that $b \rightarrow \infty$ along some sequence, for example, $b = n$ ($n = 1, 2, \dots$).

Let $N > 0$ be an arbitrary number. We consider an interval $[-N, N]$ and select from the functions $w^n(x)$ (for $n > N$) a convergent subsequence. Such a subsequence exists in view of the uniform boundedness of $w^n(x)$ and its derivatives. We denote the limit of this sequence by $w(x)$. Function $w(x)$ is monotonically nonincreasing and is a solution of system (1.3). It satisfies the condition

$$(4.18) \quad w_1(0) = \rho_1(0).$$

We increase N and repeat the preceding construction, except that, as the sequence to be considered, we select a subsequence of the previous subsequence. The resulting function $w(x)$ will then be an extension of the one constructed. Continuing further in this manner, we obtain a function $w(x)$, defined over the whole axis, monotonically nonincreasing, satisfying system (1.3) and the condition (4.18). Its limits at $\pm\infty$ are solutions of the system $F(w) = 0$ (this may be proved as was done above) and therefore equal to w_{\pm} . Boundedness of the derivatives follows from (4.14).

We show that function $w(x)$ is a strictly decreasing function. To do this, we consider system (4.12), where, in place of $u(x, t)$, we have $w(x)$, with initial

condition $y(x, 0) = -w'(x)$. Obviously, solutions of this system do not depend on t . We can write this system in the form:

$$\frac{\partial y_k}{\partial t} = a_k \frac{\partial^2 y_k}{\partial x^2} + c \frac{\partial y_k}{\partial x} + \frac{\partial F_k}{\partial u_k} y_k + \sum_{l \neq k} \frac{\partial F_k}{\partial u_l} y_l \quad (k = 1, \dots, n).$$

The last term on the right-hand side is nonnegative. Therefore, from the theorem concerning strict positiveness of solutions of parabolic equations (see Chapter 1), we conclude that $y_k(x)$ is either strictly positive or identically zero. However, the latter is excluded since it would mean that $w_k(x) = \text{const}$, which contradicts the inequality $w_- > w_+$. Thus we have shown that $w'(x) < 0$. Thus the theorem has been proved for $c > \omega^*$.

Now assume that $c = \omega^*$. Consider the sequence $c_n \searrow c$ and the sequence of solutions $w^{(n)}(x)$ corresponding to it. As was done above, we obtain for these solutions a uniform estimate of the derivatives. Repeating the preceding reasoning, we obtain a solution of system (1.3) satisfying conditions (1.4). Strict monotonicity may be proved, as was done above.

Finally, we consider the case $c < \omega^*$. Suppose that there exists a monotonically decreasing solution of system (1.3), satisfying conditions (1.4). We denote this solution by $\rho(x)$. It then follows from (4.4) that $\psi^*(\rho) = c$. But, by virtue of (4.5), $\psi^*(\rho) \geq \omega^*$, which leads to a contradiction. This completes the proof of the theorem. \square

REMARK. Instead of the requirement in the statement of the theorem that there be only two points w_+ and w_- in the interval $[w_+, w_-]$ where $F(w)$ vanishes, we could assume that function $F(w)$ vanishes at a finite number of points in the interval $[w_+, w_-]$: $w_+, w_-, w_1, \dots, w_m$, where $w_k \in (w_+, w_-)$ and vectors $p_k \geq 0$ exist such that

$$(4.19) \quad F'(w_k)p_k > 0 \quad (k = 1, \dots, m).$$

Similarly, a theorem concerning existence of waves in the bistable case is formulated (see §3), and a theorem similar to that proved just now could also be formulated for the monostable case. However, in contrast to the bistable case, this would be only a formal generalization since the indicated intermediate points cannot exist at least if the inequality in (4.6) is strict. Let us prove this. Suppose, for definiteness, that w_1 is a point such that there are no other points in the interval (w_+, w_1) at which $F(w) = 0$. By virtue of condition (4.19) we have $F(w_1 - sp_1) < 0$ for s sufficiently small. For some such s we let $w^{(1)} = w_1 + sp_1$, so that $F(w^{(1)}) < 0$ and $w^{(1)} \in [w_+, w_-]$. Further, we consider s so small that $F(w^{(0)}) > 0$, where $w^{(0)} = w_+ + sp$. We consider the interval $[w^{(0)}, w^{(1)}]$ and show that on the boundary of this interval the vector field $F(w)$ is directed towards its interior. Indeed, on the part of the boundary belonging to the plane $w_k = w_k^{(0)}$, we have

$$F_k(w) = F_k(w^{(0)}) + \sum_{l \neq k} \int \frac{\partial}{\partial w_l} F_k(w^{(0)} + s(w - w^{(0)})) ds (w_l - w_l^{(0)}) > 0,$$

$k = 1, \dots, n$. Similarly, on the part of the boundary belonging to the plane $w_k = w_k^{(1)}$, $k = 1, \dots, n$, we have $F_k(w) < 0$. Thus on the boundary of the interval considered the vector field $F(w)$ is directed towards the interior, and,

therefore, there must be a point inside of it at which function $F(w)$ vanishes, thereby contradicting our assumption.

§5. Supplement and bibliographic commentaries

The results of §§1–4 concerning the existence of waves and obtained by the Leray-Schauder method were published in [Vol 6, 7, 22, 44]. We discuss now briefly some other approaches to the Leray-Schauder method.

In [Beres 4, Bon 1, Hei 1] the Leray-Schauder method was applied to proving the existence of solutions on a finite interval, after which the length of the interval was extended to infinity. As remarked above, certain difficulties associated with passing to the limit can arise here. The models considered arise in chemical kinetics. We discuss these problems in Part III. Although there is some difference in the approach, leading to some difference in the results, in general, they are close to ours.

In [Gard 2] a monotone system is considered, consisting of two equations, arising in certain problems from biology. Here, in applying the Leray-Schauder method, use is made not of a rotation of the vector field, but of the index of a stationary point, which can be determined by virtue of the Fredholm property of the corresponding operators (see Chapter 2). In this connection, the author concentrates on one individual solution and shows that in the homotopy process there can be no other solutions in some small neighborhood of it. Validity of this assertion follows from the following consideration. The index of a stationary point, corresponding to a monotone wave, is equal to 1 for a monotone system. Therefore two monotone waves cannot come together. Monotone and nonmonotone waves are uniformly isolated from one another (in the functional sense) and therefore a nonmonotone wave also cannot fall into a small neighborhood of a monotone wave.

This approach with the separation of monotone and nonmonotone solutions may be generalized to arbitrary monotone systems, and, in addition, to locally monotone systems, as presented above. This makes it possible, in applying the Leray-Schauder method, to obtain a priori estimates, not for all, but only for monotone solutions. Moreover, the domain along whose boundary a rotation of the vector field is defined may be constructed so that it does not contain nonmonotone solutions, and this domain also changes in the homotopy process.

The results for monotone systems presented in §4 were obtained in [Vol 7, 44].

In connection with topological methods for proving the existence of waves, there is also the method of isolated invariant sets, developed by Conley [Con 1]; this method has received various applications in the study of waves [Car 2, 3, Con 1, 2, 4–6, Gard 3–5]. We shall not go into detail on this, referring the reader instead to the aforementioned papers and the book [Smo 1].

Through a study of the trajectories in phase space for the first order system

$$(5.1) \quad w' = p, \quad ap' = -cp - F(w),$$

resulting from (1.3), a proof has also been given for the existence of *wave fronts* in various other models encountered in physics, chemistry, and biology: the system of equations of combustion [Kan 4], the Belousov-Zhabotinsky reaction [Fie 1, Gib 1, Troy 2], the Fisher model [Tan 1], the process of polymerization with crystallization [Vol 33], the model for the propagation of epidemics [Kalen 1], the model for detonation [Gard 1], and the Lotka-Volterra equations [Dun 1].

Investigations are also carried out in the phase plane to prove the existence of *pulses*: for this purpose it is sufficient to establish the existence of trajectories of system (5.1) departing and arriving at a stationary point. One of the approaches consists in applying methods of bifurcation theory. In [Kuz 1] birth of a loop of a separatrix from a stationary point is shown. More precisely, the following result was obtained: if system (5.1) depends on two parameters and if, for some of their values, there is a stationary point with two zero eigenvalues, then there exist for system (1.3), for close values of the parameters, pulses of small amplitude. It was possible to establish the existence of pulses without requiring smallness of amplitude only for certain systems of a particular form (see [Bri 1, Has 2, Kee 1, Rin 4]). There is also a series of papers in which existence of solutions is established for the equation for the propagation of nerve impulses, these solutions having the form of a sequence of individual pulses (see [Eva 5, Fer 3, Has 4]). A characteristic form is shown in Figure 1.8 of the Introduction.

Existence of waves *periodic in space* may be proved with the aid of a small parameter. In this way, waves of small amplitude may be shown to exist, arising from a stationary point, and also waves close to periodic solutions of the system of first order ordinary equations

$$(5.2) \quad \frac{du}{dt} = F(u).$$

An assumption is made here for this system concerning the existence of limit cycles. The first results in this direction were obtained in [Kop 3]. The existence of waves of large speed has been shown under the assumption indicated. The gist of the matter consists in the fact that with the substitution $x = -c\xi$ in system (1.3) we obtain a system

$$\frac{1}{c^2}a \frac{d^2w}{dx^2} = \frac{dw}{dx} + F(w) = 0$$

with a small parameter as coefficient of the highest derivative if the speed c is large. The resulting truncated system (as $c \rightarrow \infty$) coincides with (5.2). A similar result concerning the existence of waves of large speed was obtained in [Con 3] using the method of isolated invariant sets.

For *multi-dimensional stationary waves* there are results for scalar equations. These were pointed out in §6 of Chapter 1. In the case of systems of equations results were obtained for the corresponding differential-difference equations ([Vol 27] compare with [Gard 3] for scalar equations). That is, a change-over was made from the differential terms with respect to the transverse (orthogonal to the cylinder axis) variables to difference terms. Three cases, A, B, and C, were considered in connection with the operator equation (1.16) (see the Introduction), and in each of them questions relating to the existence of waves were investigated. Here use was made of the results presented in §4 for monotone systems. It was assumed, for the system (0.1) (see the Introduction), that the monotonicity condition $\partial F_i / \partial u_j \geq 0$ ($i \neq j$) is satisfied, and then the differential-difference system, indicated above, being considered as one-dimensional (i.e., both the difference terms and nonlinearity were considered as a source), also turns out to be monotone.

As we have already noted, for *periodic* waves, one-dimensional and multi-dimensional, basic results concerning existence were obtained using methods of bifurcation theory (see Part II).

In addition to the works mentioned above there are also some other works devoted to the study of pulses and the periodic waves for various systems of equations describing the propagation of nerve impulse (see [**Bel 3, Erm 3, Ito 1, Mag 2, Sle 2, Ter 2, Wan 1**]). In [**Dun 2**] the existence of periodic waves is proved for the “prey-predator” model. A study of the existence of periodic waves for the diffusion-kinetic system is carried out in [**Yan 2**].

Under some assumptions it appears to be possible to prove the existence of waves for the gradient systems:

$$\frac{\partial u_i}{\partial t} = \frac{\partial^2 u_i}{\partial x^2} + \frac{\partial \Phi}{\partial u_i} \quad (i = 1, \dots, n),$$

where $\Phi(u_1, \dots, u_n)$ is a given function (see [**Rein 1, Ter 3, 4**]).

There are also other works devoted to the problem of wave existence [**Cag 1, Deng 1, Doc 2, Esq 1, Frai 1, Ike 1, Li 1, Oli 1, Zhan 1**].

CHAPTER 4

Structure of the Spectrum

In various problems of physical interest a question arises concerning structure of the spectrum of linear elliptic operators. In the present chapter we examine the qualitative location of the spectrum of elliptic operators acting on functions given in an unbounded cylinder under general boundary conditions. The need for such a study arises, for example, in the investigation of stability in a linear approximation of stationary solutions (both homogeneous as well as nonhomogeneous solutions in space) and solutions in the form of traveling waves.

Considering, for example, small perturbations u of a wave $w(x - ct)$, traveling with speed c (see (1.1), Chapter 2), we arrive at linear systems of the form

$$\frac{\partial u}{\partial t} = A \frac{\partial^2 u}{\partial x^2} + c \frac{\partial u}{\partial x} + Cu,$$

where c_{ij} are elements of the matrix C , $c_{ij} = \partial F_i / \partial u_j|_{u=w}$, and the system is written in coordinates connected with the front of the traveling wave.

In the case of more complex nonlinear systems and many spatial variables we have to deal with more involved linear problems, and, therefore, in what follows, we examine the spectrum of general elliptic operators in both one-dimensional and multi-dimensional cases.

We present the basic results of the chapter first for the case of one spatial variable and then for the case of many spatial variables.

The linear systems considered here with one spatial variable have the form

$$\frac{\partial u}{\partial t} = A(x) \frac{\partial^2 u}{\partial x^2} + B(x) \frac{\partial u}{\partial x} + C(x)u,$$

where $A(x)$, $B(x)$, $C(x)$ are $m \times m$ matrices, $u(t, x)$ is a vector-valued function, and x is a spatial variable, $-\infty < x < +\infty$. As for the matrices $A(x)$, $B(x)$, and $C(x)$, we assume that they have limits as $x \rightarrow \pm\infty$ and that the ellipticity condition with a parameter is satisfied (see below) for the operator $A(x, D) - \lambda$ (see (0.1)).

The problem concerning location of the spectrum of the operator

$$(0.1) \quad A(x, D) \equiv A(x) \frac{\partial^2 u}{\partial x^2} + B(x) \frac{\partial u}{\partial x} + C(x)u$$

is solved completely for the case in which coefficients of the operator are independent of x (such operators are encountered, for example, in studying the stability of a stationary solution, homogeneous with respect to space). We describe a method

for obtaining the spectrum in case $A(x)$, $B(x)$, and $C(x)$ are independent of x and, consequently, in place of $A(x, D)$ we can write $A(D)$. In the equation

$$\frac{\partial u}{\partial t} = A(D)u$$

in place of u we substitute the function $\exp(\lambda t + i\xi x)$. We obtain

$$\exp(\lambda t + i\xi x)(-A\xi^2 + i\xi B + C - \lambda I) = 0.$$

It turns out that the spectrum of operator $A(D)$ consists of curves $\lambda = \lambda(\xi)$ ($-\infty < \xi < +\infty$) in the complex plane, given by the equation

$$\det(-A\xi^2 + i\xi B + C - \lambda I) = 0.$$

A more complex problem concerning the spectrum of operator (0.1) arises when the coefficients of the operator depend on x . In this case we can indicate those points λ which are points of the continuous spectrum. We consider “operators at the infinities”, $A^+(D)$ and $A^-(D)$, which are obtained from operator $A(x, D)$ by letting x tend towards $+\infty$ and $-\infty$, respectively, in the coefficients. The operators $A^+(D)$ and $A^-(D)$ have constant coefficients and we can apply to them the above-described method of determining the spectrum. It turns out that the continuous spectrum of operator $A(x, D)$ is determined by the “spectra of the operators at the infinities”, $A^+(D)$ and $A^-(D)$. Besides a continuous spectrum the operator $A(x, D)$ can also have discrete eigenvalues, the qualitative location of which we shall also study in this chapter.

In the case of many spatial variables $x = (x_1, \dots, x_n)$, $-\infty < x_n < +\infty$, $(x_1, \dots, x_{n-1}) \in G$, where G is a bounded domain in \mathbb{R}^{n-1} , operator $A(x, D)$ has the form

$$A(x, D)u = \sum_{k,l=1}^n A_{kl}(x) \frac{\partial^2 u}{\partial x_k \partial x_l} + \sum_{k=1}^n A_k(x) \frac{\partial u}{\partial x_k} + A_0(x)u, \quad x \in \Omega = G \times \mathbb{R}^1;$$

on the boundary Γ of the cylinder Ω there is given the boundary operator

$$B(x, D)u = \sum_{k=1}^n B_k(x) \frac{\partial u}{\partial x_k} + B_0(x)u, \quad x \in \partial\Omega = \Gamma.$$

Here the coefficients of operators $A(x, D)$ and $B(x, D)$ are $m \times m$ matrices, having limits as $x_n \rightarrow \pm\infty$; u is a vector-valued function, $u = (u_1, \dots, u_m)$. We assume that the operator $A(x, D) - \lambda$ and the boundary operator $B(x, D)$ satisfy the condition of ellipticity with a parameter (see below).

For such operators, as in the one-dimensional problem, there exists the simpler case in which coefficients of the operators $A(x, D)$ and $B(x, D)$ do not depend on x_n . The problem concerning the structure of the spectrum is solved in a manner similar to the one-dimensional case. In the equations

$$\frac{\partial u}{\partial t} = A(x, D)u, \quad B(x, D)u|_{\Gamma} = 0$$

in place of u , we substitute the vector-valued function

$$\exp(\lambda t + i\xi_n x_n)v(x_1, \dots, x_{n-1}, \xi_n)$$

(where ξ_n is a real parameter). For the vector-valued function $v(x_1, \dots, x_{n-1}, \xi_n)$

we have a problem with parameter ξ_n in the bounded domain G . This is the so-called problem in a cross-section. The eigenvalues λ_k ($k = 1, 2, \dots$) of the problem in cross-section are functions of the parameter ξ_n ($-\infty < \xi_n < +\infty$). It proves to be the case that the spectrum of the problem being considered coincides with the family of curves $\lambda = \lambda_k(\xi_n)$ ($k = 1, 2, \dots$) in the complex λ -plane.

In the general case, when the coefficients of the operators depend on x_n , we shall refer to “problems at the infinities” (the replacement of the coefficients in operators $A(x, D)$ and $B(x, D)$ by their limits as $x_n \rightarrow \pm\infty$). In these problems the coefficients no longer depend on x_n ; the structure of the spectrum in this case is described above. The spectrum of “problems at the infinities” determines the continuous spectrum of operator $A(x, D)$, subject to the boundary operator $B(x, D)$.

In our study of the spectrum of operators elliptic with a parameter we have employed a technique similar to that used in [Agranov 1], and we have also applied the general results relating to Φ -operators (see [Gokh 1]).

This chapter consists of five sections. In §1 we give some definitions and propositions; in §2 we examine the spectrum of operators with coefficients independent of x_n ; in §3 we consider the general case; in §4 the results obtained are illustrated by means of examples and some of their applications are pointed out. In §§2 and 3, for brevity of exposition, we confine the discussion to dimensionality n greater than one of the spatial variables. In case $n = 1$ the boundary conditions are absent and the discussion is simplified. All the results remain valid (see also [Hen 1]). §5 treats the spectrum for the case of monotone systems.

The main results of this chapter have appeared in [Vol 6, 7, 10, 12, 43, 45].

§1. Elliptic problems with a parameter

We present here some well-known definitions and facts needed for the sequel.

By the space $H^l(\mathbb{R}^n)$ ($l \geq 0$) we mean the closure of the space $C_0^\infty(\mathbb{R}^n)$ of infinitely-smooth finite functions, given in the space \mathbb{R}^n , according to the norm

$$\|u\|_l = \|u\|_{H^l(\mathbb{R}^n)} = \left(\int_{\mathbb{R}^n} (1 + |\xi|^{2l}) |F_{x \rightarrow \xi} u|^2 d\xi \right)^{1/2},$$

where

$$F_{x \rightarrow \xi} u = \int_{\mathbb{R}^n} u(x) \exp(-i(x, \xi)) dx$$

is the Fourier transform of function $u(x)$. For integral l this norm is equivalent to

$$\left(\sum_{|\alpha| \leq l} \int_{\mathbb{R}^n} |D^\alpha u|^2 dx \right)^{1/2},$$

where α is a multi-index, $\alpha = (\alpha_1, \dots, \alpha_n)$, $|\alpha| = \alpha_1 + \dots + \alpha_n$, $D^\alpha = D_1^{\alpha_1} \times \dots \times D_n^{\alpha_n}$, and D_j is the operator of differentiation with respect to the j th variable x_j .

We denote by \mathbb{R}_+^n the half-space in \mathbb{R}^n , defined by the inequality $x_n \geq 0$. Let Ω be a domain in \mathbb{R}^n . Then for integral $l \geq 0$ the spaces $H^l(\mathbb{R}_+^n)$ (correspondingly,

$H^l(\Omega)$) are defined as the completion of the space of restrictions on \mathbb{R}_+^n (correspondingly, on Ω) of functions from $C_0^\infty(\mathbb{R}^n)$ according to the norm

$$\|u\|_l = \left(\sum_{|\alpha| \leq l} \int |D^\alpha u|^2 dx \right)^{1/2},$$

where the integral is taken over \mathbb{R}_+^n (correspondingly, over Ω).

For functions $u \in H^l(\mathbb{R}_+^n)$, $l \geq 1$, the boundary value (trace) of function u is defined on the hyperplane $x_n = 0$ and

$$(1.1) \quad \|u\|'_{l-1/2} \leq c \|u\|_l,$$

where $\|u\|_l$ is the norm of the space $H^l(\mathbb{R}_+^n)$ and the prime indicates that the norm $\|u\|'_{l-1/2}$ is taken over the hyperplane $x_n = 0$. The concept of the trace of function $u(x) \in H^l(\Omega)$, $l \geq 1$, integral, is defined with the aid of a local rectification of boundary $\partial\Omega$, and we have the inequality (1.1), where the norms are taken over Ω and $\partial\Omega$.

For the spaces $H^l(\mathbb{R}^n)$, $H^l(\mathbb{R}_+^n)$, $H^l(\Omega)$ we introduce yet another norm connected with the complex vector parameter q (see [**Agranov 1**]):

$$\|u\|_{l,q} = (\|u\|_l^2 + |q|^{2l} \|u\|_0^2)^{1/2},$$

where $|q|$ is the norm of vector q . Then for the trace of function u we have the inequality

$$(1.2) \quad \|u\|'_{l-1/2,q} \leq c \|u\|_{l,q}.$$

We have the interpolational inequality

$$(1.3) \quad \|u\|_{l,q}^2 \leq \sum_{k=0}^l |q|^{2k} \|u\|_{l-k}^2 \leq c \|u\|_{l,q}^2.$$

In domain $\Omega \subset \mathbb{R}^n$ let us assume there is given a differential operator A of the second order, and on the boundary $\partial\Omega$, a differential operator B of the first order ($\partial\Omega$ is assumed sufficiently smooth):

$$Au \equiv A(x, D, \lambda)u = \sum_{k,l=1}^n A_{kl}(x) \frac{\partial^2 u}{\partial x_k \partial x_l} + \sum_{k=1}^n A_k(x) \frac{\partial u}{\partial x_k} + A_0(x)u - \lambda u,$$

$$Bu \equiv B(x, D)u = \sum_{k=1}^n B_k(x) \frac{\partial u}{\partial x_k} + B_0(x)u, \quad x \in \partial\Omega.$$

The coefficients of operators A and B are sufficiently smooth $m \times m$ matrices. (We shall assume, for simplicity, that they are given over all of \mathbb{R}^n .)

We define, following [**Agranov 1**], the concept of ellipticity with a parameter λ for a pair of operators A and B , $\lambda \in K$, where K is a closed cone in the complex plane. (In processing, we shall write (A, B) , having in mind that we are given operator A , acting on functions defined in a domain, and a boundary operator B .)

A pair of operators (A, B) is said to be elliptic with a parameter $\lambda \in K$ if the following Conditions I and II are satisfied.

CONDITION I.

$$\det \left(\sum_{k,l=1}^n A_{kl}(x) \xi_k \xi_l + \lambda I \right) \neq 0$$

for arbitrary

$$\xi = (\xi_1, \dots, \xi_n) \in \mathbb{R}^n, \quad \lambda \in K, \quad x \in \bar{\Omega}$$

such that

$$|\xi| + |\lambda| \neq 0.$$

Let the boundary $\partial\Omega$ of domain Ω be covered by a number of balls S_i in such a way that in each ball S_i there is given a smooth transformation of coordinates $y = y(x)$, effecting a local diffeomorphism $S_i \cap \Omega$ in \mathbb{R}_+^n ($y_n \geq 0$), where $S_i \cap \partial\Omega$ goes over into the hyperplane $y_n = 0$. Condition II is formulated at each point x_0 of the boundary $\partial\Omega$. Suppose for definiteness that x_0 lies in the ball S_i . We consider the pair of operators (A_0, B_0) :

$$A_0 u \equiv A_0(x, D, \lambda) u = \sum_{k,l=1}^n A_{kl}(x) \frac{\partial^2 u}{\partial x_k \partial x_l} - \lambda u,$$

$$B_0 u \equiv B_0(x, D) u = \sum_{k=1}^n B_k(x) \frac{\partial u}{\partial x_k}.$$

We shall assume that the pair of operators (A_0, B_0) , described in local coordinates y , has the form

$$(\bar{A}_0, \bar{B}_0) = (\bar{A}_0(y, D, \lambda), \bar{B}_0(y, D)).$$

On the half-plane $y_n > 0$ we consider the problem

$$(1.4) \quad \bar{A}_0(y(x_0), i\xi', d/dy_n, \lambda)v = 0,$$

$$(1.5) \quad \bar{B}_0(y(x_0), i\xi', d/dy_n)v|_{y_n=0} = h,$$

the operators in which are obtained from (\bar{A}_0, \bar{B}_0) by a Fourier transformation with respect to $y' \in \mathbb{R}^{n-1}$, $y' \rightarrow \xi'$, with constant coefficients taken at the point $y(x_0)$.

CONDITION II. For arbitrary $\lambda \in K$, $\xi' \in \mathbb{R}^{n-1}$, such that $|\lambda| + |\xi'| \neq 0$, problem (1.4), (1.5) has one and only one solution in the space of stable solutions of equation (1.4) for arbitrary right-hand sides h .

In what follows we shall also use the concept of ellipticity with respect to several parameters, a concept which is defined similarly.

We recall the definition of a Φ -operator (see [Gokh 1]). Operator $L: E_1 \rightarrow E_2$ (E_1 and E_2 are Banach spaces) is called a Φ -operator if it is closed, normally solved, and has finite d -characteristics (i.e., a finite-dimensional kernel and cokernel).

Let operator L depend on a complex parameter λ , $L = L(\lambda)$. Then λ_0 is said to be a Φ -point of operator $L(\lambda)$ if operator $L(\lambda_0)$ is a Φ -operator.

We have the following theorem.

THEOREM 1.1. *The set of Φ -points of operator $L(\lambda)$ is open and, consequently, is the union of a finite or countable number of connected components. Inside each connected component the index of operator $L(\lambda)$ maintains a constant value. The dimensionality $\alpha_{L(\lambda)}$ of the kernel of operator $L(\lambda)$ also maintains a constant value*

α , with the possible exception of a set of isolated points λ_j , where $\alpha_{L(\lambda_j)} > \alpha$ (see [Gokh 1]).

§2. Continuous spectrum

In this section we consider problems of a special type in the cylinder $\Omega = G \times \mathbb{R}^1$, where G is a bounded domain in \mathbb{R}^{n-1} , in which the coefficients of the operators do not depend on x_n . (For $x \in \Omega$ we use the notation $x = (x', x_n)$, where $x' \in G$, $x_n \in \mathbb{R}^1$.)

We consider the problem

$$(2.1) \quad Au = f, \quad x \in \Omega,$$

$$(2.2) \quad Bu|_{\Gamma} = g, \quad x \in \Gamma = \partial\Omega,$$

where

$$(2.3) \quad \begin{aligned} Au &\equiv A(x', D, \lambda)u \\ &= \sum_{k,l=1}^n A_{kl}(x') \frac{\partial^2 u}{\partial x_k \partial x_l} + \sum_{k=1}^n A_k(x') \frac{\partial u}{\partial x_k} + A_0(x')u - \lambda u, \end{aligned}$$

$$(2.4) \quad Bu \equiv B(x', D)u = \sum_{k=1}^n B_k(x') \frac{\partial u}{\partial x_k} + B_0(x')u,$$

$f \in H^{l-2}(\Omega)$, $g \in H^{l-3/2}(\Gamma)$, and we seek u from $H^l(\Omega)$ (l is an integer, $l \geq 2$). Coefficients of the operators are sufficiently smooth $m \times m$ matrices, u is a vector-valued function, $u = (u_1, \dots, u_m)$.

Problem (2.1), (2.2) is assumed to be elliptic with parameter $\lambda \in K$ (K is a closed cone in the complex plane \mathbb{C}). Along with the problem (2.1), (2.2) we consider a problem in domain G , which is obtained by means of a formal Fourier transform with respect to x_n , $x_n \rightarrow \xi_n$, of the operators (2.3), (2.4),

$$(2.5) \quad \tilde{A}v(x', \xi_n) = 0, \quad x' \in G,$$

$$(2.6) \quad \tilde{B}v(x', \xi_n) = 0, \quad x' \in \partial G,$$

where

$$\begin{aligned} \tilde{A}v &\equiv \tilde{A}(x', i\xi_n, D', \lambda)v \\ &= \sum_{k,l=1}^{n-1} A_{kl}(x') \frac{\partial^2 v}{\partial x_k \partial x_l} + \sum_{k=1}^{n-1} A_k(x', \xi_n) \frac{\partial v}{\partial x_k} + A_0(x', \xi_n)v - \lambda v, \end{aligned}$$

$$A_k(x', \xi_n) = 2A_{kn}(x')i\xi_n + A_k(x'),$$

$$A_0(x', \xi_n) = -A_{nn}(x')\xi_n^2 + A_n(x')i\xi_n + A_0(x'),$$

$$\tilde{B}v \equiv \tilde{B}(x', i\xi_n, D')v = \sum_{k=1}^{n-1} B_k(x') \frac{\partial v}{\partial x_k} + B_0(x', \xi_n)v,$$

$$B_0(x', \xi_n) = B_n(x')i\xi_n + B_0(x').$$

We assume that the local coordinates for rectification of the boundary of cylinder Ω are chosen so that y_n is directed along the axis of the cylinder. We then

have the following propositions from the condition of ellipticity with parameter λ of problem (2.1), (2.2).

PROPOSITION A. *Problem (2.5), (2.6) is elliptic with parameter $\xi_n \in \mathbb{R}^1$ for arbitrary fixed $\lambda \in \mathbb{C}$.*

This means that Conditions I and II are satisfied for operators (A_0, B_0) , where

$$A_0v = \sum_{k,l=1}^{n-1} A_{kl}(x') \frac{\partial^2 v}{\partial x_k \partial x_l} - A_{nn}(x') \xi_n^2 v,$$

$$B_0v = \sum_{k=1}^{n-1} B_k(x') \frac{\partial v}{\partial x_k} + B_n(x') i \xi_n v.$$

PROPOSITION B. *Problem (2.5), (2.6) is elliptic with parameter (λ, ξ_n) for $\lambda \in K$, $\xi \in \mathbb{R}^1$, i.e., as (A_0, B_0) we take*

$$A_0v = \sum_{k,l=1}^{n-1} A_{kl}(x') \frac{\partial^2 v}{\partial x_k \partial x_l} - A_{nn}(x') \xi_n^2 v - \lambda v,$$

$$B_0v = \sum_{k=1}^{n-1} B_k(x') \frac{\partial v}{\partial x_k} + B_n(x') i \xi_n v.$$

THEOREM 2.1. *Assume that for some $\lambda \in \mathbb{C}$ and for all $\xi_n \in \mathbb{R}^1$ problem (2.5), (2.6) has only the zero solution. Then*

- 1) *for this λ problem (2.1), (2.2) is uniquely solvable for arbitrary $f \in H^{l-2}(\Omega)$, $g \in H^{l-3/2}(\Gamma)$;*
- 2) *if $\lambda \in K$ and $|\lambda|$ is sufficiently large, then we have the following a priori estimate for solution u of problem (2.1), (2.2):*

$$\|u\|_{l,\lambda} \leq c(\|f\|_{l-2,\lambda} + \|g\|'_{l-3/2,\lambda})$$

(in contrast to the definition given in §1, here and in the sequel for $\lambda \in K$, $h \in H^l$, $\|h\|_{l,\lambda} = \|h\|_l + |\lambda|^{1/2} \|h\|_0$).

PROOF. We consider the problem

$$(2.7) \quad \tilde{A}v(x', \xi_n) = \tilde{f}(x', \xi_n), \quad x' \in G,$$

$$(2.8) \quad \tilde{B}v(x', \xi_n) = \tilde{g}(x', \xi_n), \quad x' \in \partial G,$$

where $\tilde{f}(x', \xi_n)$ and $\tilde{g}(x', \xi_n)$ are the Fourier transforms of the right-hand sides $f(x', x_n)$ and $g(x', x_n)$ of problem (2.1), (2.2) with respect to x_n , $x_n \rightarrow \xi_n$. Functions $\tilde{f}(x', \xi_n)$ and $\tilde{g}(x', \xi_n)$ belong to the spaces $H^{l-2}(G)$ and $H^{l-3/2}(\partial G)$, respectively, for almost all $\xi_n \in \mathbb{R}^1$. Problem (2.7), (2.8) will be considered specifically for these values of ξ_n . By virtue of Proposition A the index of problem (2.5), (2.6) is equal to zero, and the unique solvability of problem (2.7), (2.8) follows from the conditions of the theorem.

We show that for almost all $x' \in G$ the inverse Fourier transform exists for function $v(x', \xi_n)$, the solution of problem (2.7), (2.8). For $|\xi_n| > M$, and M sufficiently large, we have, in view of Proposition A, the estimate (see [Agranov 1])

$$|\xi|^{2l} \|v\|_0^2 \leq c(\|\tilde{f}\|_{l-2, \xi_n}^2 + \|\tilde{g}\|_{l-3/2, \xi_n}^2),$$

where the norms are taken over G and ∂G . From this we have

$$\int_{|\xi_n| > M} |\xi_n|^{2l} \|v\|_0^2 d\xi_n < +\infty, \quad \int_{|\xi_n| > M} \int_G |\xi_n|^{2l} |v(x', \xi_n)|^2 dx' d\xi_n < +\infty.$$

Consequently, for almost all $x' \in G$,

$$\int_{|\xi_n| > M} |\xi_n|^{2l} |v(x', \xi_n)|^2 d\xi_n < +\infty.$$

In addition, as is readily seen,

$$\int_{-M}^M |\xi_n|^{2l} |v(x', \xi_n)|^2 d\xi_n < +\infty$$

for almost all $x' \in G$. Therefore

$$\int_{-\infty}^{\infty} |\xi_n|^{2l} |v(x', \xi_n)|^2 d\xi_n < +\infty$$

and for almost all $x' \in G$ there exists $u(x', x_n) = F_{\xi_n \rightarrow x_n}^{-1} v(x', \xi_n)$.

We show that u so determined belongs to $H^l(\Omega)$. Indeed,

$$\begin{aligned} \|u\|_l^2 &= \int_{G \times \mathbb{R}^1} \sum_{|\alpha| \leq l} |D^\alpha u|^2 dx = \int_G dx' \int_{\mathbb{R}^1} \sum_{|\alpha| \leq l} |D^\alpha u|^2 dx_n \\ &= \int_G dx' \int_{\mathbb{R}^1} \sum_{|\beta| + k \leq l} |D_{x', \xi_n}^{\beta, k} v(x', \xi_n)|^2 dx_n \\ &= \int_{\mathbb{R}^1} d\xi_n \sum_{|\beta| + k \leq l} |\xi_n|^{2k} \int_G |D_{x'}^\beta v(x', \xi_n)|^2 dx' \\ &= \int_{\mathbb{R}^1} \sum_{k \leq l} |\xi_n|^{2k} \|v(x', \xi_n)\|_{l-k}^2 d\xi_n \leq c \int_{\mathbb{R}^1} \|v\|_{l, \xi_n}^2 d\xi_n < +\infty. \end{aligned}$$

Thus $u \in H^l(\Omega)$ and by a simple substitution we verify that $u(x', x_n)$ is a solution of problem (2.1), (2.2).

We now prove the second assertion of the theorem. Using the a priori estimate for large $|\lambda|$, $\lambda \in K$, and almost all $\xi_n \in \mathbb{R}^1$,

$$\|v\|_{l,(\xi_n,\lambda)} \leq c(\|\tilde{f}\|_{l-2,(\xi_n,\lambda)}^2 + \|\tilde{g}\|_{l-3/2,(\xi_n,\lambda)}^2),$$

which follows from Proposition B (see [Agranov 1]) (the norms are taken over G and ∂G), we have

$$\begin{aligned} \|u\|_{l,\lambda}^2 &\leq 2(\|u\|_l^2 + |\lambda|^l \|u\|_0^2) = 2 \int_{G \times \mathbb{R}^1} \left(\sum_{|\alpha| \leq l} |D^\alpha u|^2 + |\lambda|^l |u|^2 \right) dx \\ &= 2 \int_G dx' \int_{\mathbb{R}^1} \left(\sum_{|\alpha| \leq l} |F_{x_n \rightarrow \xi_n} D^\alpha u|^2 + |\lambda|^l |F_{x_n \rightarrow \xi_n} u|^2 \right) d\xi_n \\ &= 2 \int_{\mathbb{R}^1} d\xi_n \left(\sum_{|\beta|+k \leq l} |\xi_n|^{2k} \int_G |D_{x'}^\beta v(x', \xi_n)|^2 dx' + |\lambda|^l \int_G |v(x', \xi_n)|^2 dx' \right) \\ &\leq c_1 \int_{\mathbb{R}^1} \|v\|_{l,(\xi_n,\lambda)}^2 d\xi_n \leq c_2 \int_{\mathbb{R}^1} (\|\tilde{f}\|_{l-2,(\xi_n,\lambda)}^2 + \|\tilde{g}\|_{l-3/2,(\xi_n,\lambda)}^2) d\xi_n \\ &\leq c(\|f\|_{l-2,\lambda}^2 + \|g\|_{l-3/2,\lambda}^2). \end{aligned}$$

Thus we have proved the assertions of Theorem 1. □

We introduce set Λ , the set of eigenvalues of problem (2.5), (2.6) for all possible $\xi_n \in \mathbb{R}^1$:

$$\Lambda = \{\lambda \in \mathbb{C}, \lambda = \lambda(\xi_n), -\infty < \xi_n < +\infty\}.$$

It follows from Theorem 2.1 that points λ of the complex plane not belonging to Λ are regular points of problem (2.1), (2.2).

We show that an arbitrary point λ , belonging to Λ , is not a regular point of problem (2.1), (2.2) (moreover, it is not a Φ -point).

LEMMA 2.1. *Let the point λ be an eigenvalue of problem (2.5), (2.6) for some ξ_n . Then there exists a function $\omega(x') \in H^{l-2}(G)$, $\omega \not\equiv 0$, and a functional $\varphi \in (H^{l-3/2}(\partial G))^*$, such that for an arbitrary function $v(x') \in H^l(G)$, we have the equality*

$$\int_G (\omega(x'), \tilde{A}(x', i\xi_n, D', \lambda)v) dx' + \varphi(\tilde{B}(x', i\xi_n, D')v) = 0.$$

PROOF. The pair of operators (\tilde{A}, \tilde{B}) , considered as an operator acting from $H^l(G)$ into $H^{l-2}(G) \times H^{l-3/2}(\partial G)$, is a normally solvable operator and has zero index. Therefore there exists a functional $\psi \in (H^{l-2}(G) \times H^{l-3/2}(\partial G))^*$ such that $\psi\{(\tilde{A}, \tilde{B})v\} = 0$ for all $v \in H^l(G)$. It is easy to see that ψ has the form $\psi = \{\omega, \varphi\}$, where $\omega \in H^{l-2}(G)$ and $\varphi \in (H^{l-3/2}(\partial G))^*$, and $\psi(\tilde{f}, \tilde{g}) = \int_G (\omega, \tilde{f}) dx' + \varphi(\tilde{g})$, where $\tilde{f} = \tilde{A}v$, $\tilde{g} = \tilde{B}v$. □

LEMMA 2.2. *Let ω and φ be the same as in the preceding lemma. Then for an arbitrary function $u \in H^l(\Omega)$, with a finite support (equal to zero for $|x_n| > R$), we have the equality*

$$\int_{\Omega} (\omega(x') \exp(i\xi_n x_n), A(x', D, \lambda)u) dx + \int_{\mathbb{R}} \exp(-i\xi_n x_n) \varphi(B(x', D)u) dx_n = 0.$$

PROOF. Let $\Delta(x) = B(x', D)u(x)$. We show that the function $\varphi(\Delta(x))$ is continuous with respect to x_n for smooth $u(x)$ satisfying the condition of the lemma.

We have ($\|\varphi\|$ is the norm of φ in the space $(H^{l-3/2}(\partial G))^*$)

$$\begin{aligned} |\varphi(\Delta(\cdot, x_n)) - \varphi(\Delta(\cdot, \bar{x}_n))| &\leq \|\varphi\| \|\Delta(\cdot, x_n) - \Delta(\cdot, \bar{x}_n)\|'_{l-3/2} \\ &\leq c \|\Delta(\cdot, x_n) - \Delta(\cdot, \bar{x}_n)\|_{l-1} \rightarrow 0 \quad \text{as } x_n \rightarrow \bar{x}_n, \end{aligned}$$

since the coefficients of operator B are assumed to be sufficiently smooth.

For smooth u we have

$$\int_{\Omega} (\omega(x') \exp(i\xi_n x_n), A(x', D, \lambda)u) dx = \int_{\Omega} (\omega(x'), \tilde{A}(x', i\xi_n, D', \lambda)v) dx',$$

where

$$v(x', \xi_n) = \int_{\mathbb{R}^1} \exp(-i\xi_n x_n) u(x', x_n) dx_n.$$

Since function $\Delta(x)$ can be integrated with respect to x_n , then

$$\begin{aligned} &\int_{\mathbb{R}^1} \exp(-i\xi_n x_n) \varphi(B(x', D)u) dx_n \\ &= \varphi \left(\int_{\mathbb{R}^1} \exp(-i\xi_n x_n) B(x', D)u dx_n \right) = \varphi(\tilde{B}(x', i\xi_n, D')v), \end{aligned}$$

from which we conclude that the lemma is valid in the case of smooth functions u . For nonsmooth $u \in H^l(\Omega)$ the lemma may be proved by a passage to the limit. \square

THEOREM 2.2. *Let λ be an eigenvalue of problem (2.5), (2.6). Then there exists a function $\omega(x') \in H^{l-2}(G)$, $\omega \not\equiv 0$, such that for solvability of the problem*

$$(2.9) \quad A(x', D, \lambda)u = f,$$

$$(2.10) \quad B(x', D)u|_{\partial\Omega} = 0$$

in the space $H^l(\Omega)$ ($u \in H^l(\Omega)$), where the right-hand sides f are summable, $f \in L_1(\Omega)$, it is necessary that

$$(2.11) \quad \int_{\Omega} (\omega(x') \exp(i\xi_n x_n), f(x)) dx = 0.$$

PROOF. Let $u \in H^l(\Omega)$ be a solution of problem (2.9), (2.10). We introduce function $\omega_R(x_n)$ ($R > 0$) possessing the following properties: $\omega_R(x_n) \in C_0^\infty(\mathbb{R}^1)$, $\omega_R(x_n) = 1$ for $|x_n| < R$, $\omega_R(x_n) = 0$ for $|x_n| > R + 1$, $0 \leq \omega_R(x_n) \leq 1$ for arbitrary $x_n \in \mathbb{R}^1$.

Let $u_R(x) = u(x)\omega_R(x_n)$. Then by virtue of the preceding lemma

$$(2.12) \quad \int_{\Omega} (\omega(x') \exp(i\xi_n x_n), A(x', D, \lambda)u_R(x)) dx + \int_{\mathbb{R}^1} \exp(-i\xi_n x_n) \varphi(B(x', D)u_R(x', x_n)) dx_n = 0.$$

In this equation we let $R \rightarrow +\infty$.

Let

$$\Omega_R = \Omega \cap \{x: |x_n| \leq R\} \quad \text{and} \quad G_R = \Omega \cap \{x: R < |x_n| < R+1\}.$$

Then

$$I(\Omega) \equiv \int_{\Omega} (\omega(x') \exp(i\xi_n x_n), A(x', D, \lambda)u_R(x)) dx = I(\Omega_R) + I(G_R),$$

where $I(\Omega_R)$ and $I(G_R)$ are integrals of the same integrand as $I(\Omega)$, but taken over the sets Ω_R and G_R , respectively. We have

$$I(\Omega_R) = \int_{\Omega_R} (\omega(x') \exp(i\xi_n x_n), f(x)) dx; \quad I(G_R) \xrightarrow{R \rightarrow \infty} 0.$$

Therefore

$$I(\Omega_R) \xrightarrow{R \rightarrow \infty} \int_{\Omega} (\omega(x') \exp(i\xi_n x_n), f(x)) dx.$$

Further, it follows from (2.10) that $B(x', D)u_R = 0$ for $|x_n| < R$. Therefore

$$\begin{aligned} & \left| \int_{\mathbb{R}^1} \exp(-i\xi_n x_n) \varphi(B(x', D)u_R(x', x_n)) dx_n \right| \\ &= \left| \int_{R \leq |x_n| \leq R+1} \exp(-i\xi_n x_n) \varphi(B(x', D)u_R(x', x_n)) dx_n \right| \\ &\leq \|\varphi\| \int_{R \leq |x_n| \leq R+1} \|B(x', D)u_R(x', x_n)\|'_{H^{l-3/2}(\partial G)} dx_n \\ &\leq c \int_{R \leq |x_n| \leq R+1} \|B(x', D)u_R(x', x_n)\|_{l-1} dx_n \xrightarrow{R \rightarrow \infty} 0. \end{aligned}$$

Thus, compelling the passage to the limit in (2.12), we obtain (2.11). □

COROLLARY 1. *If point λ is an eigenvalue of problem (2.5), (2.6) for some ξ_n , then λ is a point of the spectrum of problem (2.1), (2.2).*

PROOF. It is sufficient to show that there exists a function $f(x) \in L_1(\Omega) \cap H^{l-2}(\Omega)$ such that (2.11) is not satisfied. Indeed if (2.11) were to be satisfied for all smooth functions f having compact support (and they belong to $L_1(\Omega) \cap H^{l-2}(\Omega)$), we would then have $\omega(x') \equiv 0$, which contradicts the condition of Theorem 2.2. □

COROLLARY 2. *If point λ is an eigenvalue of problem (2.5), (2.6) for some ξ_n , then λ is not a Φ -point of the pair of operators (2.3), (2.4).*

PROOF. Suppose the assertion of the corollary is not true and λ is a Φ -point of the pair of operators (2.3), (2.4). Then there exists a finite number p of linearly independent functions v_1, \dots, v_p , belonging to $H^{l-2}(\Omega)$ and such that for solvability

of problem (2.1), (2.2) with right-hand side f and zero boundary conditions it is necessary and sufficient that $(f, v_i)_{H^{l-2}(\Omega)} = 0$ ($i = 1, \dots, p$). We arrive at a contradiction upon constructing $f \in L_1(\Omega) \cap H^{l-2}(\Omega)$ such that it is orthogonal to all the v_i ($i = 1, \dots, p$), but with (2.11) not satisfied. Indeed, we can select an interval $[-R, R]$ such that the functions v_i ($i = 1, \dots, p$), considered on the set $G \times [-R, R]$, are linearly independent and $\omega(x') \exp(i\xi_n x_n)$ cannot be represented on $G \times [-R, R]$ as a linear combination of them. Therefore there exists a function $\bar{f} \in H^{l-2}(G \times [-R, R])$ such that

$$(\bar{f}, v_i)_{H^{l-2}(G \times [-R, R])} = 0 \quad (i = 1, \dots, p);$$

but

$$\int_{G \times [-R, R]} (\omega(x') \exp(i\xi_n x_n), \bar{f}) dx \neq 0.$$

Moreover, \bar{f} can be selected to have a finite support $G \times [-R, R]$. Continuing \bar{f} by zero onto the whole cylinder Ω , we obtain a function f orthogonal to v_i , $i = 1, \dots, p$, but for which (2.11) is not satisfied. The resulting contradiction establishes the corollary. \square

THEOREM 2.3. *The spectrum of problem (2.1), (2.2) is the set of the eigenvalues of problem (2.5), (2.6) for all possible $\xi_n \in \mathbb{R}^1$. Points $\lambda \in \Lambda$ are not Φ -points of the operator (2.3), (2.4).*

§3. Structure of the spectrum

In this section we study the spectrum of operator $\theta = (A, B)$, acting on functions $u(x)$, given in the cylinder $\Omega = G \times \mathbb{R}^1$,

$$\theta: H^l(\Omega) \rightarrow H^{l-2}(\Omega) \times H^{l-3/2}(\partial\Omega).$$

Here A is a second order differential operator with matrix coefficients

$$(3.1) \quad Au \equiv A(x, D, \lambda)u = \sum_{k,l=1}^n A_{kl}(x) \frac{\partial^2 u}{\partial x_k \partial x_l} + \sum_{k=1}^n A_k(x) \frac{\partial u}{\partial x_k} + A_0(x)u - \lambda u,$$

$$x \in \Omega, \quad u(x) \in H^l(\Omega), \quad A: H^l(\Omega) \rightarrow H^{l-2}(\Omega),$$

and B is a boundary differential operator with matrix coefficients

$$(3.2) \quad Bu \equiv B(x, D)u = \sum_{k=1}^n B_k(x) \frac{\partial u}{\partial x_k} + B_0(x)u,$$

$$x \in \partial\Omega = \Gamma, \quad B: H^l(\Omega) \rightarrow H^{l-3/2}(\partial\Omega).$$

Coefficients of the operators are sufficiently smooth $m \times m$ matrices having limits as $x_n \rightarrow \pm\infty$. We denote these limits by the signs “+” (limit as $x_n \rightarrow +\infty$) and “-” (limit as $x_n \rightarrow -\infty$), placed above. For example,

$$A_{kl}^+(x') = \lim_{x_n \rightarrow +\infty} A_{kl}(x); \quad A_{kl}^-(x') = \lim_{x_n \rightarrow -\infty} A_{kl}(x).$$

We denote by θ^+ and θ^- the operators obtained by replacement of the coefficients

in θ by their limits as $x_n \rightarrow +\infty$ and $x_n \rightarrow -\infty$, respectively. For example, $\theta^+ = (A^+, B^+)$, where

$$(3.3) \quad \begin{aligned} A^+u &\equiv A^+(x', D, \lambda)u \\ &= \sum_{k,l=1}^n A_{kl}^+(x') \frac{\partial^2 u}{\partial x_k \partial x_l} + \sum_{k=1}^n A_k^+(x') \frac{\partial u}{\partial x_k} + A_0^+(x')u - \lambda u, \end{aligned}$$

$$(3.4) \quad B^+u \equiv B^+(x', D)u = \sum_{k=1}^n B_k^+(x') \frac{\partial u}{\partial x_k} + B_0^+(x')u.$$

We assume that the coefficients of operators A and B and their derivatives to order $l - 2$ converge to their limits as $x_n \rightarrow \pm\infty$, uniformly with respect to $x' \in G$.

We require that operators θ, θ^+ , and θ^- be elliptic with parameter $\lambda \in K \subset \mathbb{C}$, where K is a closed cone in \mathbb{C} .

To study the spectrum of operator θ we need the following lemmas.

LEMMA 3.1. *In the space $H^l(\mathbb{R}^n)$ we consider the operator \overline{K} of multiplication by function $k(x)$ ($k(x)$ has a compact support and has continuous derivatives to order $l + \alpha$ inclusive; α is an arbitrary integer greater than $n/2$). Then $\overline{K} = E + T$, where T is completely continuous and E is bounded,*

$$\|E\|_{H^l(\mathbb{R}^n) \rightarrow H^l(\mathbb{R}^n)} \leq C \sup_{x \in \mathbb{R}^n} |k(x)|,$$

where C does not depend on $k(x)$.

PROOF. Let $v(x) = k(x)u(x)$. Then

$$\tilde{v}(\xi) = \int \tilde{k}(\xi - \eta) \tilde{u}(\eta) d\eta,$$

where “ \sim ” denotes Fourier transform, and the integral is taken over \mathbb{R}^n . We have

$$\begin{aligned} (1 + |\xi|^l) \tilde{v}(\xi) &= \int (1 + |\eta|^l) \tilde{k}(\xi - \eta) \tilde{u}(\eta) d\eta \\ &\quad + \int (|\xi|^l - |\eta|^l) \tilde{k}(\xi - \eta) \tilde{u}(\eta) d\eta, \quad v(x) = E_1u + T_1u, \end{aligned}$$

where

$$\begin{aligned} E_1u &= F_{\xi \rightarrow x}^{-1} \left(\frac{1}{(1 + |\xi|^l)} \int (1 + |\eta|^l) \tilde{k}(\xi - \eta) \tilde{u}(\eta) d\eta \right), \\ T_1u &= F_{\xi \rightarrow x}^{-1} \left(\frac{1}{(1 + |\xi|^l)} \int (|\xi|^l - |\eta|^l) \tilde{k}(\xi - \eta) \tilde{u}(\eta) d\eta \right). \end{aligned}$$

We estimate the norm of E_1 in $H^l(\mathbb{R}^n)$. Let

$$\omega = F^{-1}[(1 + |\eta|^l) \tilde{u}(\eta)].$$

We have

$$\begin{aligned}
\|E_1 u\|_l^2 &= \int (1 + |\xi|^{2l}) |FE_1 u|^2 d\xi \\
&= \int \frac{1 + |\xi|^{2l}}{(1 + |\xi|^l)^2} \left| \int (1 + |\eta|^l) \tilde{k}(\xi - \eta) \tilde{u}(\eta) d\eta \right|^2 d\xi \\
&\leq \int d\xi \left| \int \tilde{k}(\xi - \eta) \tilde{\omega}(\eta) d\eta \right|^2 = \int |\omega k|^2 dx \\
&\leq \sup_{x \in \mathbb{R}^n} |k(x)|^2 \int (1 + |\eta|^l)^2 |\tilde{u}(\eta)|^2 d\eta \leq \sup_{x \in \mathbb{R}^n} 2|k(x)|^2 \|u\|_l^2.
\end{aligned}$$

From this it follows that

$$\|E_1\|_{H^l(\mathbb{R}^n) \rightarrow H^l(\mathbb{R}^n)} \leq \sqrt{2} \sup_{x \in \mathbb{R}^n} |k(x)|.$$

We show that $\|T_1 u\|_l \leq c \|u\|_{l-1}$:

$$\begin{aligned}
\|T_1 u\|_l^2 &= \int \frac{1 + |\xi|^{2l}}{(1 + |\xi|^l)^2} \left| \int (|\xi|^l - |\eta|^l) \tilde{k}(\xi - \eta) \tilde{u}(\eta) d\eta \right|^2 d\xi \\
&\leq \int \left| \int (|\xi|^l - |\eta|^l) \tilde{k}(\xi - \eta) \tilde{u}(\eta) d\eta \right|^2 d\xi \\
&= \int \left| \int (|\xi|^l - |\xi - \tau|^l) \tilde{k}(\tau) \tilde{u}(\xi - \tau) d\tau \right|^2 d\xi \\
&= \int \left| \int \frac{1}{1 + |\tau|^\alpha} (1 + |\tau|^\alpha) (|\xi|^l - |\xi - \tau|^l) \tilde{k}(\tau) \tilde{u}(\xi - \tau) d\tau \right|^2 d\xi \\
&\leq \int \frac{d\tau}{(1 + |\tau|^\alpha)^2} \int d\xi \int (1 + |\tau|^\alpha)^2 |\xi|^l - |\xi - \tau|^l |\tilde{k}(\tau)|^2 |\tilde{u}(\xi - \tau)|^2 d\tau \\
&\leq c_1 \iint (1 + |\tau|^\alpha)^2 |\xi|^l - |\xi - \tau|^l |\tilde{k}(\tau)|^2 |\tilde{u}(\xi - \tau)|^2 d\xi d\tau \\
&\leq c_1 \iint (1 + |\tau|^\alpha)^2 |\eta + \tau|^l - |\eta|^l |\tilde{k}(\tau)|^2 |\tilde{u}(\eta)|^2 d\eta d\tau \\
&\leq c_2 \iint (1 + |\eta|^{2l-2}) |\tilde{u}(\eta)|^2 (1 + |\tau|^{2\alpha+2l}) |\tilde{k}(\tau)|^2 d\eta d\tau \\
&= c_2 \|k\|_{l+\alpha}^2 \|u\|_{l-1}^2 = c^2 \|u\|_{l-1}^2.
\end{aligned}$$

Let S be an operator of multiplication in $H^l(\mathbb{R}^n)$ on a smooth function $s(x)$ with a compact support, equal to 1 in a neighborhood of the support of function $k(x)$. Then $\overline{K} = K\overline{S} = E + T$, where $E = E_1\overline{S}$, $T = T_1\overline{S}$.

We show that the operators E and T satisfy the conditions of the lemma. Indeed,

$$\|E\| = \|E_1\overline{S}\| \leq c_1 \|E_1\| \leq c \sup_{x \in \mathbb{R}^n} |k(x)|.$$

Assume now that $\{u_m\}$, $m = 1, 2, \dots$, is bounded in $H^l(\mathbb{R}^n)$. Then Su_m is also bounded in $H^l(\mathbb{R}^n)$ and RSu_m is bounded in $H^l(\Omega)$ (R is an operator of restriction, $R: H^l(\mathbb{R}^n) \rightarrow H^l(\Omega)$, where Ω is a bounded domain containing the support of $s(x)$). Hence there exists a subsequence $\{\overline{u}_k\}$ of the sequence $\{u_m\}$ such that $RS\overline{u}_k$ converges in the space $H^{l-1}(\Omega)$; consequently, $LR\overline{S}\overline{u}_k$ converges in $H^{l-1}(\mathbb{R}^n)$ (here L is an operator of continuation, $L: H^l(\Omega) \rightarrow H^l(\mathbb{R}^n)$, such

that for function $\varphi(x)$, $\text{supp } \varphi \subset \text{supp } s$, we have $LR\varphi = \varphi$. Then $T_1 LRS\bar{u}_k$ converges in $H^l(\mathbb{R}^n)$, but $T_1 LRS\bar{u}_k = T\bar{u}_k$. Thus, for an arbitrary sequence $\{u_m\}$, bounded in $H^l(\mathbb{R}^n)$, we can select a subsequence $\{\bar{u}_k\}$, such that $\{T\bar{u}_k\}$ converges in $H^l(\mathbb{R}^n)$; consequently, T is completely continuous. This completes the proof of the lemma. \square

LEMMA 3.2. *In the space $H^l(\mathbb{R}_+^n)$ we consider the operator \bar{K} of multiplication by function $k(x)$ ($k(x)$ has a compact support and has continuous derivatives to order $l + \alpha$ inclusive; α is an arbitrary integer greater than $n/2$). Then $\bar{K} = \bar{E} + \bar{T}$, where \bar{T} is completely continuous and \bar{E} is bounded,*

$$\|\bar{E}\|_{H^l(\mathbb{R}_+^n) \rightarrow H^l(\mathbb{R}_+^n)} \leq c \sup_{x \in \mathbb{R}_+^n} |k(x)|.$$

PROOF. Let L be an operator of continuation of functions from $H^l(\mathbb{R}_+^n)$ into functions from $H^l(\mathbb{R}^n)$. Let \bar{K}_1 be the operator of multiplication by function $k_1(x) = Lk(x)$, acting in $H^l(\mathbb{R}^n)$. It follows from the form of operator L that $k_1(x)$ satisfies the conditions of Lemma 3.1 and

$$\sup_{x \in \mathbb{R}^n} |k_1(x)| = \sup_{x \in \mathbb{R}_+^n} |k(x)|.$$

Therefore, by virtue of the preceding lemma, $\bar{K}_1 Lu = ELu + TLu$, where operators E and T were defined in Lemma 3.1. We have $R\bar{K}_1 Lu = RELu + RTLu$, where R is an operator of restriction, $R: H^l(\mathbb{R}^n) \rightarrow H^l(\mathbb{R}_+^n)$; but $R\bar{K}_1 Lu = Ku$; consequently, $\bar{K}u = \bar{E}u + \bar{T}u$, where $\bar{E} = REL$ and $\bar{T} = RTL$ satisfy the conditions of the lemma. \square

We proceed now to a study of the spectrum of operator θ . We denote the spectrum of operator θ^+ by Λ_+ and of θ^- by Λ_- . (Structure of the sets Λ_+ and Λ_- are described in the preceding section.) Let $\Lambda = \Lambda_+ \cup \Lambda_-$, and let us denote by K , as we did above, the cone appearing in the definition of ellipticity with parameter λ of operator θ^+ . We then have the following theorem.

THEOREM 3.1. *Operator θ is a Φ -operator for $\lambda \in K/\Lambda$.*

PROOF. We cover cylinder Ω by a system of domains $\{\Omega_\nu\}$ ($\nu = 1, \dots, N$) such that $\Omega_1 = G \times (-\infty, -M)$, $\Omega_N = G \times (M, +\infty)$ (M is a sufficiently large positive number). The domains $\Omega_\nu, \nu = 2, \dots, N - 1$, are balls, they cover $G \times [-M, M]$, and are sufficiently small (the precise meaning of smallness of $\Omega_\nu, \nu = 2, \dots, N - 1$, and of the size of M will be given below). In addition, we require that if $\Omega_\nu \cap \Gamma \neq \emptyset$ ($\nu = 2, \dots, N - 1$), then Ω_ν will lie entirely in some S_i and the center of Ω_ν will lie on Γ (S_i is a system of balls, covering the boundary Γ , in which locally diffeomorphic coordinate transformations $y = y(S_i, x)$, rectifying the boundary, are given (see §1)).

In cylinder Ω we construct an infinitely smooth partition of unity $\{\varphi_\nu\}, \nu = 1, \dots, N$, $\sum_{\nu=1}^n \varphi_\nu(x) = 1$ for $x \in \Omega$, subject to the covering $\{\Omega_\nu\}$. Also we introduce functions $\psi_\nu(x), x \in \Omega$, such that $\psi_\nu(x) = 1$ for x lying in a neighborhood of Ω_ν , and $\psi_\nu(x) = 0$ outside of some larger neighborhood. Then $D^\alpha(\varphi_\nu \psi_\nu) = D^\alpha \varphi_\nu$ and

$$(3.5) \quad \theta u = \sum_{\nu=1}^N \varphi_\nu \theta(\psi_\nu u).$$

This sum consists of terms of three types: terms with $\nu = 1$ or $\nu = N$, terms such that $\Omega_\nu \cap \Gamma \neq 0$, and terms for which $\Omega_\nu \cap \Gamma = 0$. In the terms of the second type we go over to local coordinates, rectifying the boundary in the limits of S_i . In terms of the third type we identify θ with $A(x, D, \lambda)$ (since $B\psi_\nu u|_r = 0$) and by means of the local coordinates we designate the initial coordinates x . In terms of the first type we also designate the initial coordinates x by means of the local coordinates. (In what follows, we assume that the right-hand side of (3.5) is written in local coordinates, denoted, for simplicity, throughout by x .)

We now construct the operators θ_ν . Coefficients of these operators coincide with coefficients of operator θ in some neighborhood of the support of function ψ_ν (undertstood as a set in $\mathbb{R}^n, \mathbb{R}_+^n$, or the cylinder, depending on the type of term) and are constant outside of some larger neighborhood:

$$(3.6) \quad \theta^\nu = \alpha_\nu(x)\theta + [1 - \alpha_\nu(x)]\theta(x_\nu).$$

Here for $\nu = 2, \dots, N - 1$ the function $\alpha_\nu(x)$ is smooth, with compact support, and equal to one in a neighborhood of the support of function ψ_ν ; $\theta(x_\nu)$ is an operator, which is obtained from θ by taking its coefficients at the point x_ν (x_ν belongs to the support of function $\varphi_\nu(x)$ and is taken on the image of $\Gamma \cap S_i$, if this intersection is not empty). Thus, depending on the typed of term, $\theta^\nu: H^l(\mathbb{R}^n) \rightarrow H^{l-2}(\mathbb{R}^n)$ or $\theta^\nu: H^l(\mathbb{R}_+^n) \rightarrow H^{l-2}(\mathbb{R}_+^n) \times H^{l-3/2}(\mathbb{R}^{n-1})$. For $\nu = 1$ or N the function $\alpha_\nu(x)$ is given in cylinder Ω , is equal to one in a neighborhood of the support of $\psi_\nu(x)$, and is equal to zero outside of some larger neighborhood. By $\theta(x_\nu)$ we mean θ^+ (for $\nu = N$) or θ^- (for $\nu = 1$). Thus $\theta^\nu(\Omega) \rightarrow H^{l-2}(\Omega) \times H^{l-3/2}(\Gamma)$.

By virtue of the definition of operators θ^ν we have the equality

$$(3.7) \quad \varphi_\nu\theta(\psi_\nu u) = \varphi_\nu\theta^\nu(\psi_\nu u).$$

We denote by θ_0^ν the principal part of operator θ^ν : for $\nu = 1$ or $N, \theta_0^\nu = \theta^\nu$; for $\nu = 2, \dots, N - 1$ the principal part θ_0^ν consists of the sum of those terms of operator θ^ν , which contain the highest derivatives (second derivatives in the operator acting in \mathbb{R}^n or \mathbb{R}_+^n , and first derivatives in the boundary operator) and the parameter λ . \square

LEMMA 3.3. *For arbitrary $\lambda \in K/\Lambda$ the number M in the covering $\{\Omega_\nu\}$ ($\nu = 1, \dots, N$) can be chosen so large, and the balls $\{\Omega_\nu\}$ ($\nu = 2, \dots, N - 1$) so small that the operators θ_0^ν ($\nu = 1, \dots, N$) have left and right regularizers.*

PROOF. Let $\nu = 1$. Then

$$R^\nu\theta_0^\nu = R^\nu\alpha_\nu(x)[\theta_0^\nu - \theta^-] + I = E_\nu + I,$$

where R^ν is inverse to θ^- (existing, since $\lambda \notin \Lambda_-$). Number M can be chosen so large that operator E_ν is small. Consequently, operator θ_0^ν is uniquely invertible. Invertibility of operator θ_0^N may be proved in a similar way.

Let $\nu = 2, \dots, N - 1$ and let R^ν be the left inverse to operator $\theta_0^\nu(x_\nu)$ (existing by virtue of ellipticity with parameter of operator θ , see [Agranov 1]). We can then construct a left regularizer for θ_0^ν . Indeed,

$$R^\nu\theta_0^\nu = R^\nu\alpha_\nu(x)[\theta_0^\nu - \theta_0^\nu(x_\nu)] + I = E_\nu + T_\nu + I,$$

where T_ν is completely continuous by virtue of lemmas concerning multiplication by a function with a compact support, and, for Ω_ν sufficiently small, $\|E_\nu\| < 1/2$. Similarly, we can establish the presence of a right regularizer for the operator θ_0^ν .

A method for constructing the covering $\{\Omega_\nu\}$ ($\nu = 1, \dots, N$) follows from this lemma. It is constructed so that the operators θ_0^ν have regularizers.

Let us continue the proof of the theorem. By (3.5) and (3.7) we have

$$\theta u = \sum_{\nu=1}^N \varphi_\nu \theta^\nu (\psi_\nu u).$$

Now let R_μ be the right regularizer for operator θ_0^μ .

We then define the operator

$$R(f, g) = \sum_{\mu=1}^N \psi_\mu R_\mu(\varphi_\mu f, \varphi_\mu g).$$

R is a bounded operator from $H^{l-2}(\Omega) \times H^{l-3/2}(\Gamma)$ into $H^l(\Omega)$. We show that R is a right regularizer for θ . Indeed,

$$(3.8) \quad \theta R(f, g) = (I + T)(f, g),$$

$$(3.9) \quad \begin{aligned} T(f, g) &= \sum_{\nu, \mu=1}^N \varphi_\nu [\theta^\mu \psi_\mu \psi_\nu - \psi_\mu \psi_\nu \theta^\mu] u_\mu \\ &+ \sum_{\nu, \mu=1}^N \varphi_\nu \psi_\mu \psi_\nu [\theta^\mu - \theta_0^\mu] u_\mu + T_1(f, g), \end{aligned}$$

where $u_\mu = R_\mu(\varphi_\mu f, \varphi_\mu g)$ and operator T_1 is completely continuous (if the operators R_μ were inverse to θ_0^μ rather than regularizers, then $T_1 = 0$).

We show that T is completely continuous. For $\mu = 1$ or N we have $\theta^\mu - \theta_0^\mu = 0$, and for $\mu = 2, \dots, N - 1$ the operator $\theta^\mu - \theta_0^\mu$ does not contain higher derivatives, and therefore the operator $\varphi_\nu \psi_\mu \psi_\nu [\theta^\mu - \theta_0^\mu]$ is completely continuous. In a similar way we establish the complete continuity of operator $\varphi_\nu [\theta^\mu \psi_\mu \psi_\nu - \psi_\mu \psi_\nu \theta^\mu]$. Thus, T is completely continuous; consequently, R is a right regularizer for θ . Similarly, we may show that θ has a left regularizer. Therefore θ is a Φ -operator for $\lambda \in K \setminus \Lambda$. \square

THEOREM 3.2. *The problem $\theta u = (f, g)$ is uniquely solvable for sufficiently large $|\lambda|$, $\lambda \in K \setminus \Lambda$.*

PROOF. Let us prove solvability (see [Agranov 1]). For sufficiently large $|\lambda|$, $\lambda \in K \setminus \Lambda$, we have the equality (see Theorem 3.1) $\theta R(f, g) = (I + T)(f, g)$ for arbitrary $f \in H^{l-2}(\Omega)$, $g \in H^{l-3/2}(\Gamma)$,

$$T(f, g) = \sum_{\nu, \mu=1}^N \varphi_\nu [\theta^\mu \psi_\mu \psi_\nu - \psi_\mu \psi_\nu \theta^\mu] u_\mu + \sum_{\nu, \mu=1}^N \varphi_\nu \psi_\mu \psi_\nu [\theta^\mu - \theta_0^\mu] u_\mu.$$

Here the term $T_1(f, g)$ is absent (compare (3.9)) since for sufficiently large $|\lambda|$, $\lambda \in K \setminus \Lambda$, the operators θ_0^μ are invertible (see §2) and as R_μ we take the inverses to θ_0^μ .

For the functions $f \in H^{l-2}(\mathbb{R}_+^n)$, $g \in H^{l-3/2}(\mathbb{R}^{n-1})$ and $f \in H^{l-2}(\Omega)$, $g \in H^{l-3/2}(\Gamma)$ we define $\| (f, g) \|_l = \| f \|_{l-2, \lambda} + \| g \|'_{l-3/2, \lambda}$.

We then have (the norms are taken, in accordance with the type of terms, with respect to \mathbb{R}_+^n and \mathbb{R}^{n-1} , Ω and Γ , or \mathbb{R}^n):

$$\begin{aligned}
& \| |\varphi_\nu [\theta^\mu \psi_\mu \psi_\nu - \psi_\mu \psi_\nu \theta^\mu] u_\mu \| | | = \| |\varphi_\nu [\theta \psi_\mu \psi_\nu - \psi_\mu \psi_\nu \theta] u_\mu \| | | \\
& = \| |\varphi_\nu [A \psi_\mu \psi_\nu - \psi_\mu \psi_\nu A] u_\mu \| | |_{l-2, \lambda} + \| |\varphi_\nu [B \psi_\mu \psi_\nu - \psi_\mu \psi_\nu B] u_\mu \| | |'_{l-3/2, \lambda} \\
& \leq c_1 \{ \| |(A \psi_\mu \psi_\nu - \psi_\mu \psi_\nu A) u_\mu \| | |_{l-2, \lambda} + \| |(B \psi_\mu \psi_\nu - \psi_\mu \psi_\nu B) u_\mu \| | |'_{l-3/2, \lambda} \} \\
& \leq c_2 \{ \| |(A \psi_\mu \psi_\nu - \psi_\mu \psi_\nu A) u_\mu \| | |_{l-2, \lambda} + \| |(B \psi_\mu \psi_\nu - \psi_\mu \psi_\nu B) u_\mu \| | |_{l-1, \lambda} \} \\
& \leq c_3 \| |u_\mu \| | |_{l-1}.
\end{aligned}$$

Here we have made use of the boundedness of the operator of multiplication by φ_ν , the inequality (1.2), and the absence of higher derivatives in the operators $A \psi_\mu \psi_\nu - \psi_\mu \psi_\nu A$ and $B \psi_\mu \psi_\nu - \psi_\mu \psi_\nu B$.

In view of the interpolational inequality and the boundedness of operator R_μ , we have

$$\| |u_\mu \| | |_{l-1, \lambda} \leq \frac{c_1}{\sqrt{|\lambda|}} \| |u_\mu \| | |_{l, \lambda} \leq \frac{c_1}{\sqrt{|\lambda|}} \| |(f, g) \| | |_{l}.$$

Thus,

$$\| |\varphi_\nu [\theta^\mu \psi_\mu \psi_\nu - \psi_\mu \psi_\nu \theta^\mu] u_\mu \| | | \leq \frac{c'}{\sqrt{|\lambda|}} \| |(f, g) \| | |_{l}.$$

Similarly, we may show that

$$\| |\varphi_\nu \psi_\mu \psi_\nu [\theta^\mu - \theta_0^\mu] u_\mu \| | | \leq \frac{c''}{\sqrt{|\lambda|}} \| |(f, g) \| | |_{l}.$$

From this we obtain

$$\| |T(f, g) \| | |_{l} \leq \frac{c}{\sqrt{|\lambda|}} \| |(f, g) \| | |_{l}.$$

Choosing $|\lambda|$ sufficiently large, we have

$$\| |T(f, g) \| | |_{l} \leq \frac{1}{2} \| |(f, g) \| | |_{l}.$$

Consequently, operator $I + T$ is invertible and problem $\theta u = (f, g)$ has a solution $u = R(I + T)^{-1}(f, g)$.

In order to prove uniqueness of a solution of problem $\theta u = (f, g)$ for large $|\lambda|$, $\lambda \in K \setminus \Lambda$, it is sufficient to establish the a priori estimate

$$(3.10) \quad \| |u \| | |_{l, \lambda} \leq c (\| |Au \| | |_{l-2, \lambda} + \| |Bu \| | |'_{l-3/2, \lambda}).$$

We cover cylinder Ω by a system of domains Ω_k ($k = 1, \dots, N$), described in Theorem 3.1 (possibly with a different N). We construct a smooth partition of

unity $\{\varphi_k\}$ ($k = 1, \dots, N$), subject to the covering $\{\Omega_k\}$. Then for an arbitrary function $u \in H^l(\Omega)$

$$\|u\|_{l,\lambda} = \left\| \sum_{k=1}^N \varphi_k u \right\|_{l,\lambda} \leq \sum_{k=1}^N \|\varphi_k u\|_{l,\lambda}.$$

We estimate $\|\varphi_1 u\|_{l,\lambda}$, denoting $\varphi_1 u = v$. By virtue of an a priori estimate (Theorem 2.1), we have

$$\begin{aligned} \|v\|_{l,\lambda} &\leq c_1(\|A^- v\|_{l-2,\lambda} + \|B^- v\|'_{l-3/2,\lambda}) \\ &\leq c_1(\|(A - A^-)v\|_{l-2,\lambda} + \|(B - B^-)v\|'_{l-3/2,\lambda} + \|Av\|_{l-2,\lambda} + \|Bv\|'_{l-3/2,\lambda}). \end{aligned}$$

Let c_2 be a constant in the inequality

$$\|(B - B^-)v\|'_{l-3/2,\lambda} \leq c_2\|(B - B^-)v\|_{l-1,\lambda}.$$

We choose ε so small ($\varepsilon > 0$) that $c_1\varepsilon(1 + c_2) < 1/3$. We can select $M = M(\varepsilon)$ so large that

$$\begin{aligned} \|(A - A^-)v\|_{l-2,\lambda} &\leq \varepsilon\|v\|_{l,\lambda} + c_3(\varepsilon)\|v\|_{l-1,\lambda}, \\ \|(B - B^-)v\|_{l-2,\lambda} &\leq \varepsilon\|v\|_{l,\lambda} + c_3(\varepsilon)\|v\|_{l-1,\lambda}. \end{aligned}$$

Constants c_1 , c_2 , and c_3 are independent of λ for sufficiently large $|\lambda|$, $\lambda \in K \setminus \Lambda$.

Thus,

$$\begin{aligned} \|v\|_{l,\lambda} &\leq c_1(\|Av\|_{l-2,\lambda} + \|Bv\|'_{l-3/2,\lambda}) + c_1\varepsilon(1 + c_2)\|v\|_{l,\lambda} \\ &\quad + c_3(\varepsilon)c_1(1 + c_2)\|v\|_{l-1,\lambda} \\ &\leq c_1(\|Av\|_{l-2,\lambda} + \|Bv\|'_{l-3/2,\lambda}) + 2/3\|v\|_{l,\lambda} \end{aligned}$$

for

$$\sqrt{|\lambda|} > 3c_4c_3(\varepsilon)c_1(1 + c_2),$$

where c_4 is a constant in the inequality

$$\|v\|_{l-1,\lambda} \leq \frac{c_4}{\sqrt{|\lambda|}}\|v\|_{l,\lambda}.$$

From this we obtain

$$\|v\|_{l,\lambda} \leq c(1)(\|Av\|_{l-2,\lambda} + \|Bv\|'_{l-3/2,\lambda}),$$

where $c(1) = 3c_1$.

In a similar way we obtain the following estimate for $\varphi_N u$:

$$\|\varphi_N u\|_{l,\lambda} \leq c(N)(\|A\varphi_N u\|_{l-2,\lambda} + \|B\varphi_N u\|'_{l-3/2,\lambda}).$$

Estimates for $\varphi_k u$, $k = 2, \dots, N - 1$ (see [Agranov 1]), are

$$\|\varphi_k u\|_{l,\lambda} \leq c(k)(\|A\varphi_k u\|_{l-2,\lambda} + \|B\varphi_k u\|'_{l-3/2,\lambda}).$$

Thus,

$$\|u\|_{l,\lambda} \leq \bar{c} \sum_{k=1}^N (\|A\varphi_k u\|_{l-2,\lambda} + \|B\varphi_k u\|'_{l-3/2,\lambda}),$$

where $\bar{c} = \max_{1 \leq i \leq N} c(i)$.

We have

$$\|A\varphi_k u\|_{l-2,\lambda} \leq \|\varphi_k A u\|_{l-2,\lambda} + c_5 \|u\|_{l-1,\lambda} \leq c_6 \left(\|A u\|_{l-2,\lambda} + \frac{1}{\sqrt{|\lambda|}} \|u\|_{l,\lambda} \right).$$

Similarly,

$$\|B\varphi_k u\|'_{l-3/2,\lambda} \leq c_7 \left(\|B u\|'_{l-3/2,\lambda} + \frac{1}{\sqrt{|\lambda|}} \|u\|_{l,\lambda} \right).$$

Choosing $|\lambda|$ sufficiently large, we obtain the a priori estimate (3.10). This completes the proof of the theorem. \square

COROLLARY 1. *Let K_0 be an unbounded component of connectivity of the set $K \setminus \Lambda$. Then there exists a number R , such that points λ , belonging to K_0 and such that $|\lambda| > R$, are regular points of operator θ . For arbitrary ε , $\varepsilon > 0$, in the domain described by the conditions $\lambda \in K_0$, $\text{dist}(\lambda, \Lambda) > \varepsilon$, there can only be a finite number of eigenvalues of operator θ , the remaining points λ are regular points.*

This corollary is proved by applying Theorems 3.1, 3.2, and 1.1.

COROLLARY 2. *Assume that we are given operator θ , elliptic with parameter λ , $\lambda \in K$, and cone K of the complex λ -plane containing the right half-plane $\text{Re } \lambda > 0$. We assume that problems in cross-sections for operators θ^+ and θ^- have eigenvalues only in the left half-plane for arbitrary $\xi_n \in \mathbb{R}^1$. Then the continuous spectrum of operator θ lies in the left half-plane.*

It follows from Theorem 3.1 that all points λ of the complex plane, such that $\lambda \in K \setminus \Lambda$, are Φ -points of operator θ . We show that $\lambda \in \Lambda$ are not Φ -points of operator θ . We carry out the proof for $\lambda \in \Lambda_+$; the proof for $\lambda \in \Lambda_-$ is similar.

LEMMA 3.4. *Let $\lambda \in \Lambda_+$, i.e., λ is an eigenvalue of a problem in the cross-section for operator (A^+, B^+) for some ξ_n . We consider an arbitrary function $u(x) \in H^l(\Omega)$, $B^+ u|_\Gamma = 0$. Then for arbitrary numbers N_0 and N we have the equality*

$$(3.11) \quad \int_G \int_{N_0}^N (\omega(x') \exp(i\xi_n x_n), A^+ u) dx = I_1(N) - I_1(N_0) + I_2(N) - I_2(N_0),$$

where

$$\begin{aligned} I_1(a) &= \varphi(B_n^+(x')u(x', a) \exp(-i\xi_n x_n)), \\ I_2(a) &= \int_G \left(\omega(x'), 2 \sum_{k=1}^{n-1} A_{kn}^+(x') \frac{\partial u(x', a)}{\partial x_k} + A_{nn}^+(x') \frac{\partial u(x', x_n)}{\partial x_n} \Big|_{x_n=a} \right. \\ &\quad \left. + (A_{kn}^+ i\xi_n + A_n^+(x'))u(x', a) \right) dx' \exp(i\xi_n a). \end{aligned}$$

(Function $\omega(x')$ and functional φ were introduced in Lemma 2.1.)

PROOF. Using the form of operator A^+ and integrating by parts, we obtain

$$\int_G \int_{N_0}^N (\omega(x') \exp(i\xi_n x_n), A^+ u) dx = \int_G (\omega(x'), \tilde{A}^+ v) dx' + I_2(N) - I_2(N_0),$$

\tilde{A}^+ is the operator in the cross-section for operator A^+ ,

$$v(x', \xi_n) = \int_{N_0}^N u(x', x_n) \exp(-i\xi_n x_n) dx_n.$$

Further, in view of the fact that $B^+ u|_\Gamma = 0$, we have

$$\tilde{B}^+ v = -B_n^+(x') u(x', N) \exp(-i\xi_n N) + B_n^+(x') u(x', N_0) \exp(-i\xi_n N_0)$$

(\tilde{B}^+ is the operator in the cross-section for operator B^+). Equation (3.11) follows from this by virtue of Lemma 2.1. \square

THEOREM 3.3. *Let $\lambda \in \Lambda_+$. Then λ is not a Φ -point of operator θ .*

PROOF. Let $\lambda \in \Lambda_+$ and be a Φ -point of operator θ . Then for N_1 sufficiently large, λ will be a Φ -point also of operator θ_{N_1} , having the form

$$\theta_{N_1} = h_1(x_n)\theta + h_2(x_n)\theta^+,$$

where $(h_1(x_n), h_2(x_n))$ is a smooth partition of unity subject to covering of the line by two domains $(-\infty, N_1)$ and $(N_1 - 1, +\infty)$. Indeed, we have $\|\theta - \theta_{N_1}\| \leq \varepsilon(N_1)$ (by $\|\cdot\|$ we mean the norm of the operator acting from $H^l(\Omega)$ into $H^{l-2}(\Omega) \times H^{l-3/2}(\Gamma)$), where $\varepsilon(N_1) \rightarrow 0$ as $N_1 \rightarrow +\infty$. Therefore (see [Gokh 1]), point λ is a Φ -point of operator θ_{N_1} . But then there exists a finite number of functions v_1, \dots, v_p , belonging to $H^{l-2}(\Omega)$, such that for solvability of the problem $\theta_{N_1} u = (f, 0)$ for $f \in H^{l-2}(\Omega)$ it is necessary and sufficient that f be orthogonal to all v_i ($i = 1, \dots, p$) in the space $H^{l-2}(\Omega)$. On the other hand, if for right-hand side f the problem $\theta_{N_1} u = (f, 0)$ is solvable, then, since for $x_n > N_1$ the coefficients of operators θ_{N_1} and θ^+ coincide, we have, by virtue of (3.11), the following equality (for arbitrary $N > N_0 > N_1$):

$$(3.12) \quad \int_G \int_{N_0}^N (\omega(x') \exp(i\xi_n x_n), f) dx = I_1(N) - I_1(N_0) + I_2(N) - I_2(N_0).$$

We arrive at a contradiction, which proves the theorem, if we construct a function $f \in H^{l-2}(\Omega)$, which is orthogonal to all the v_i ($i = 1, \dots, p$), but for which (3.12) does not hold. There exists a function

$$\bar{f} \in H^{l-2}(\Omega \cap \{x_n > N_0\})$$

such that

$$\int_G \int_{N_0}^N (\omega(x') \exp(i\xi_n x_n), \bar{f}) dx \rightarrow +\infty$$

as $N \rightarrow +\infty$. It can be extended onto the whole cylinder Ω , such that

$$f \in H^{l-2}(\Omega) \quad \text{and} \quad (f, v_i)_{H^{l-2}(\Omega)} = 0 \quad (i = 1, \dots, p)$$

(f is a continuation of function \bar{f} onto the whole cylinder Ω). For this it may be necessary to select a larger N_0 . Consequently, we can select a sequence of numbers $\{N_k\}$, $N_k \rightarrow +\infty$, as $k \rightarrow +\infty$, such that the right-hand side of equation (3.12), where in place of N we have N_k , has a finite limit as $k \rightarrow +\infty$. But the left-hand side of equation (3.12) tends towards infinity as $k \rightarrow +\infty$, i.e., (3.12) cannot be satisfied, and the theorem is thereby proved. \square

COROLLARY 1. *The spectrum of operator θ has the following structure.*

All points λ of the complex plane, belonging to Λ , are points of the spectrum; moreover, they are not Φ -points of operator θ .

All points λ , $\lambda \in \mathbb{C} \setminus \Lambda$, are Φ -points of operator θ .

There exists a number R such that the points λ , $\lambda \in K$, $|\lambda| > R$, are regular points of operator θ .

In an unbounded component of connectivity K_0 of cone K (see Corollary 1 to Theorem 3.2), among the points not belonging to Λ , there can be only an isolated set of eigenvalues of finite multiplicity, which can be concentrated only towards Λ . The remaining points are regular points.

COROLLARY 2. *Assume we are given operator θ , elliptic with parameter λ , $\lambda \in K$, and a cone K of the complex λ -plane containing the right half-plane $\text{Re } \lambda > 0$. The continuous spectrum of operator θ lies in the left half-plane if and only if the problems in cross-sections for operators θ^+ and θ^- have eigenvalues only in the left half-plane for arbitrary $\xi_n \in \mathbb{R}^1$.*

REMARK 1. The results of this chapter can be carried over to the case of domains more general than a cylinder. As such domains we have those domains M for which, for R sufficiently large, the domain $M \cap \{|x| > R\}$ is diffeomorphic to a finite number of semi-cylinders.

A qualitative study can be made of the structure of the spectrum of an elliptic operator, acting on functions specified on the surface Π of an unbounded cylinder Ω . Here the boundary operator B is not present and the condition of ellipticity with parameter reduces to just Condition I. The results are similar to those obtained above.

§4. Examples

We consider some examples illustrating the results obtained. We shall not give precise statements as to the type of ellipticity with parameter condition, the convergence of the coefficients, the form of the space, since they can be readily supplied from the material presented above.

1. Let the equation

$$(4.1) \quad \frac{\partial v}{\partial t} = d\Delta v + f(v), \quad y \in \Omega = G \times \mathbb{R}^1$$

with boundary conditions

$$(4.2) \quad h_1 \frac{\partial v}{\partial \nu} + h_2(v - v_0)|_{\Gamma} = 0, \quad y \in \Gamma = \partial\Omega$$

have a solution in the form of a wave $v(t, y) = \bar{v}(y', y_n - ct)$, traveling with speed c along axis y_n . Here Δ is the Laplace operator with respect to the variables y_1, \dots, y_n ; d, h_1, h_2 are positive constants; $v_0 = v_0(y)$. As is well known, such

problems are model problems in questions relating to the propagation of a flame, a nerve impulse, etc. Linearization on the traveling wave \bar{v} for problem (4.1), (4.2) in the coordinates $(t, x', x_n) = (t, y', y_n - ct)$, attached to the front of the wave, yields the result

$$(4.3) \quad \frac{\partial u}{\partial t} = d\Delta u + f'(\bar{v})u - c \frac{\partial u}{\partial x_n} \equiv Lu,$$

$$(4.4) \quad h_1 \frac{\partial u}{\partial \nu} + h_2 u|_{\Gamma} = 0.$$

Let us find the continuous spectrum Λ of elliptic operator L , subject to the boundary conditions (4.4), corresponding to the problem (4.3), (4.4). We assume that $\bar{v}(x', x_n)$ has limits as $x_n \rightarrow \pm\infty$:

$$v_{\pm}(x') = \lim_{x_n \rightarrow \pm\infty} \bar{v}(x', x_n).$$

In (4.3) we pass to the limit as $x_n \rightarrow \pm\infty$ and we consider the corresponding problems in cross-section, letting $a_{\pm}(x') = f'(v_{\pm}(x'))$

$$(4.5) \quad d\Delta \tilde{u} + a_{\pm}(x')\tilde{u} - \mu \tilde{u} = 0, \quad x \in G,$$

$$(4.6) \quad h_1 \frac{\partial \tilde{u}}{\partial \nu} + h_2 \tilde{u}|_{\Gamma} = 0,$$

where Δ is the Laplace operator with respect to x' , $\tilde{u} = \tilde{u}(x', \xi_n)$, $\mu = d\xi^2 + ci\xi + \lambda$.

Let $\mu = \mu_k^{\pm}$ ($k = 1, 2, \dots$) be the eigenvalues for problem (4.5), (4.6). Then, according to the results in §3, the structure of spectrum of elliptic operator L , with the boundary conditions (4.4), is the following. All points λ of the parabolas $\lambda = \mu_k^{\pm} - d\xi^2 - ci\xi$, $k = 1, 2, \dots$, $-\infty < \xi < +\infty$, are points of the continuous spectrum (are not Φ -points) of operator L with the boundary conditions (4.4); all points λ of the complex plane, not lying on these parabolas and the negative half-axis, are Φ -points. The parabola $\lambda = \mu_0 - d\xi^2 - ci\xi$ ($\mu_0 = \max \mu_k^{\pm}$, $k = 1, 2, \dots$) divides the complex plane into two connected components. Those points of the complex plane that lie in the component containing the half-line $\lambda > \mu_0$ and which are at a distance of at least ε from the parabola $\lambda = \mu_0 - d\xi^2 - ci\xi$ (for arbitrary positive ε), are regular points for operator L with the boundary conditions (4.4), with the exception of not more than a finite number of points, the latter being eigenvalues.

2. We consider the system

$$(4.7) \quad \frac{\partial v}{\partial t} = D \frac{\partial^2 v}{\partial y^2} + f(v), \quad -\infty < y < +\infty,$$

where v and $f(v)$ are vector-valued functions, $v = (v_1, \dots, v_m)$, $f(v) = (f(v_1), \dots, f(v_m))$, and D is a diagonal matrix with positive elements d_i ($i = 1, 2, \dots, m$).

Systems of the form (4.7) describe processes of chemical kinetics with diffusion and heat conduction.

Assume that a vector v_0 exists such that $f(v_0) = 0$. Then v_0 is a stationary solution, homogeneous with respect to space, of system (4.7) and the problem, linearized on it, has the form

$$\frac{\partial u}{\partial t} = D \frac{\partial^2 u}{\partial y^2} + Cu \equiv Lu,$$

where C is a matrix with the elements $\partial f_i / \partial v_j|_{v=v_0}$.

We find the spectrum Λ of operator L . By the results obtained in §2, the set Λ consists of the curves $\lambda = \lambda(\xi)$ ($-\infty < \xi < +\infty$) determined from the equation

$$\det(-D\xi^2 + C - \lambda I) = 0.$$

For example, if D is a scalar matrix, $D = dI$, then Λ is the union of the half-lines $\lambda(\xi) = \lambda_i - d\xi^2$ ($-\infty < \xi < +\infty$), where λ_i are the eigenvalues of matrix C . It follows from this that for Λ to lie in the left half-plane, it is necessary and sufficient that all the eigenvalues of matrix C lie in the left half-plane. In case D is not a scalar matrix, the condition for stability of matrix C is no longer sufficient for Λ to lie in the left half-plane. However, if there exists a diagonal matrix T , with positive elements on the diagonal, such that $CT + TC'$ (the prime indicates transpose) is negative-definite, then Λ lies in the left half-plane. In many problems of the form (4.7), where the source f is defined by chemical kinetics, this case is often encountered. For example, this is the situation when all reactions are reversible and conditions for a detailed equilibrium are satisfied.

Let us assume that equation (4.7) has a solution in the form of a traveling wave $v(t, y) = \bar{v}(y + ct)$. This case is of interest since it describes the propagation of a wave of combustion with complex kinetics. In coordinates connected with the front of the traveling wave, the problem linearized on it has the form

$$\frac{\partial u}{\partial t} = D \frac{\partial^2 u}{\partial x^2} - c \frac{\partial u}{\partial x} + C(x)u \equiv L_1 u,$$

where C is the matrix with elements $\partial f_i / \partial v_j|_{v=\bar{v}}$.

We consider the structure of the spectrum of operator L_1 . Assume that the traveling wave $\bar{v}(x)$ joins two stationary states v_+ and v_- , i.e., $\bar{v}(x) \rightarrow v_{\pm}$ as $x \rightarrow \pm\infty$ and $f(v_{\pm}) = 0$. Let $C^{\pm} = \partial f_i / \partial v_j|_{v=v_{\pm}}$. Then points of the curves $\lambda = \lambda_l^{\pm}(\xi)$, $-\infty < \xi < +\infty$, $l = 1, \dots, m$, determined from the equation $\det(-D\xi^2 + ci\xi + C^{\pm} - \lambda I) = 0$, are points of the continuous spectrum of operator L_1 . We denote the set of these curves by Λ . Then in an arbitrary connected domain K_1 of the set $C \setminus \Lambda$, containing sufficiently distant points of the positive semi-axis and at a positive distance from Λ , there can be no more than a finite number of eigenvalues of operator L_1 . The remaining points of domain K_1 are regular points. If K_1 is sufficiently far from Λ , then all of its points are regular points of operator L_1 . It follows from this, in particular, that the right-hand boundary of the continuous spectrum of operator L_1 coincides with the maximum of the right-hand boundaries of the spectra of problem (4.7), linearized on v_+ and v_- .

3. In the cylinder Ω we consider the problem

$$(4.8) \quad \frac{\partial \theta}{\partial t} = \Delta \theta + cf(\theta), \quad \frac{\partial c}{\partial t} = L\Delta c - \gamma cf(\theta)$$

with boundary conditions

$$(4.9) \quad \left. \frac{\partial \theta}{\partial \nu} \right|_{\partial \Omega} = 0, \quad \left. \frac{\partial c}{\partial \nu} \right|_{\partial \Omega} = 0.$$

Here Δ is the Laplace operator with respect to $y = (y_1, y_2, y_3) \in \Omega$, $L > 0$, $\gamma > 0$. Function $f(\theta)$ is nonnegative, where $f(\theta) = 0$ for $0 \leq \theta \leq \theta_0$, and $f(\theta) > 0$ for $\theta_0 < \theta \leq 1$.

Problem (4.8), (4.9) can serve as the model of a combustion process with a single overall reaction of the first order, disregarding reaction at low temperatures.

Assume that problem (4.8), (4.9) has a solution in the form of a traveling wave $\theta(t, y) = \bar{\theta}(y_3 + \omega t)$, $c(t, y) = \bar{c}(y_3 + \omega t)$, where $\bar{\theta}(x_3) \rightarrow 1$, $\bar{c}(x_3) \rightarrow 0$ as $x_3 \rightarrow +\infty$ and $\bar{\theta}(x_3) \rightarrow 0$, $\bar{c}(x_3) \rightarrow 1$ as $x_3 \rightarrow -\infty$.

We consider problem (4.8), (4.9), linearized on $(\bar{\theta}, \bar{c})$, in coordinates x , connected with the front of the traveling wave. It has the form

$$(4.10) \quad \begin{aligned} \frac{\partial u}{\partial t} &= \Delta u + \bar{c}f'(\bar{\theta})u + f(\bar{\theta})v - \omega \frac{\partial u}{\partial x_3}, \\ \frac{\partial v}{\partial t} &= L\Delta v - \gamma\bar{c}f'(\bar{\theta})u - \gamma f(\bar{\theta})v - \omega \frac{\partial v}{\partial x_3}, \end{aligned}$$

with the boundary conditions

$$(4.11) \quad \left. \frac{\partial u}{\partial \nu} \right|_{\partial\Omega} = 0, \quad \left. \frac{\partial v}{\partial \nu} \right|_{\partial\Omega} = 0.$$

It follows from the results of this chapter that the operator appearing on the right-hand side of (4.10), with boundary conditions (4.11), does not have a continuous spectrum in the right half-plane.

Indeed, by virtue of §3, it is sufficient to show that operators in cross-sections for problems at the infinities do not have eigenvalues in the right half-plane, a fact which may be verified directly.

Similar results can be obtained for problems describing combustion processes, which are more general than problems (4.8), (4.9).

4. Consider the operator

$$(4.12) \quad D\Delta u - \omega \frac{\partial u}{\partial x_n} + A(x)u,$$

acting on functions u , given in the n -dimensional cylinder $\Omega = G \times \mathbb{R}^1$, $u \in H^l(\Omega)$, with the boundary conditions

$$(4.13) \quad \left. \frac{\partial u}{\partial \nu} + hu \right|_{\partial\Omega} = 0, \quad h > 0.$$

Here D is an $m \times m$ diagonal matrix with positive elements on the diagonal, and $A(x)$ is a sufficiently smooth $m \times m$ matrix with limits $A^\pm(x')$ as $x_n \rightarrow \pm\infty$.

For an arbitrary vector $\xi \in \mathbb{R}^n$ and arbitrary $x' \in G$, let the following condition be satisfied:

$$(4.14) \quad (\xi, A^\pm(x')\xi) \leq 0.$$

Then the continuous spectrum of operator (4.12) lies in the left half-plane. Indeed, as a consequence of the results obtained in §3, it is sufficient to show that the eigenvalues of the problem

$$(4.15) \quad -D\xi^2 v + D\Delta' v - \omega i\xi v + A^\pm(x')v - \lambda v = 0 \quad x' \in G;$$

$$(4.16) \quad \left. \frac{\partial v}{\partial \nu} + hv \right|_{\partial\Omega} = 0,$$

where Δ' is the Laplace operator with respect to $x' = (x_1, \dots, x_{n-1}) \in G$, lie in the

left half-plane. Taking the inner product of (4.15) with v integrating over G , we have

$$\begin{aligned} \lambda \int |v|^2 dx' &= -\xi^2 \int (v, Dv) dx' + \int (v, D\Delta'v) dx' \\ &\quad - \omega i \xi \int |v|^2 dx' + \int (v, A^\pm(x')v) dx'. \end{aligned}$$

Transforming $\int (v, D\Delta'v) dx'$ in accordance with Green's formula, with use of the boundary condition (4.16), we obtain

$$\operatorname{Re} \lambda \int |v|^2 dx' < \operatorname{Re} \int (v, A^\pm(x')v) dx'.$$

By virtue of condition (4.14) we have $\operatorname{Re} \lambda < 0$, which is what we wished to prove.

§5. Spectrum of monotone systems

In this section, for monotone systems, we consider a linear operator obtained by linearization on a monotone wave:

$$Lu = A(x)u'' + C(x)u' + B(x)u,$$

where $A(x)$, $B(x)$, $C(x)$ are smooth matrices; A and C are diagonal matrices; A has positive diagonal elements; and B has nonnegative off-diagonal elements. We assume that matrices A , B , and C have limits as $x \rightarrow \pm\infty$ and that the matrices

$$B_\pm = \lim_{x \rightarrow \pm\infty} B(x)$$

have negative principal eigenvalues. We assume also that matrix $B(x)$ is irreducible in the functional sense. This means that if in place of the elements of this matrix we substitute zeros when the elements are identically equal to zero, and substitute ones in the contrary case, we then obtain an irreducible matrix. We denote the diagonal elements of matrices $A(x)$ and $C(x)$ by $a_k(x)$ and $c_k(x)$, $k = 1, \dots, n$, respectively; and we denote the elements of matrix $B(x)$ by $b_{kl}(x)$.

The fundamental theorem concerning distribution of the eigenvalues of operator L is the following:

THEOREM 5.1. *Suppose that a positive solution exists for the equation*

$$Lw = 0.$$

Then if

$$(5.1) \quad \lim_{x \rightarrow \pm\infty} w(x) = 0,$$

the following assertions are valid:

1. *The equation*

$$(5.2) \quad Lu = \lambda u, \quad u(\pm\infty) = 0$$

has no solutions different from zero for $\operatorname{Re} \lambda \geq 0$, $\lambda \neq 0$.

2. *Each solution of equation (5.2) for $\lambda = 0$ has the form $u(x) = kw(x)$, where k is a constant.*

3. *The adjoint equation*

$$(5.3) \quad L^*v = 0, \quad v(\pm\infty) = 0$$

has a positive solution. It is unique to within a constant factor.

If condition (5.1) is not satisfied, then equation (5.2) has no solutions different from zero for $\text{Re } \lambda \geq 0$.

To prove this theorem we need some auxiliary propositions.

LEMMA 5.1. *Suppose matrix T has nonnegative off-diagonal elements and a negative principal eigenvalue. Then there exists a vector $p > 0$ such that $Tp < 0$.*

PROOF. Let $\tau > 0$, and let p be a solution of the equation $Tp = -\tau$. Then $p = -T^{-1}\tau > 0$, since $-T^{-1} \geq 0$. \square

LEMMA 5.2. *If $u(x) \geq 0$ is a nonzero solution of the equation*

$$(5.4) \quad Lu = 0,$$

then $u(x) > 0$.

PROOF. Let $u(x) \geq 0$ be a nonzero solution of equation (5.4). We assume that $u(x)$ is not strictly positive. We denote the elements of vector $u(x)$ by $u_k(x)$, $k = 1, \dots, n$. Obviously, $u_k(x)$ satisfies the inequality

$$a_k u_k'' + c_k u_k' + b_{kk} u_k \leq 0,$$

and, therefore, based on the theorem concerning strict positiveness of solutions (see Chapter 1), $u_k(x)$ is either strictly positive or identically equal to zero. We introduce a transformation of the elements of vector u such that all zero elements appear in the first positions, i.e., the new vector has the form $(0, \tilde{u})$, where $\tilde{u}(x) > 0$ is a vector of k elements, $0 < k < n$. If, in addition, we make a corresponding rearrangement of the equations in the system (5.4), the resulting system will then have the same form as the initial system. This means that if we retain this notation for the new system, matrices A and C are then diagonal matrices and B has nonnegative off-diagonal elements. Thus we arrive at the equation $\tilde{B}(x)\tilde{u}(x) \equiv 0$, where $\tilde{B}(x)$ is the matrix appearing at the intersection of the first $n - k$ rows and the last k columns of matrix $B(x)$. Since $\tilde{B}(x) \geq 0$, $\tilde{u}(x) > 0$, then $\tilde{B}(x) \equiv 0$, which contradicts the functional irreducibility of matrix $B(x)$. This contradiction proves the lemma. \square

LEMMA 5.3. *Let $q_{\pm} > 0$ be vectors such that $B_{\pm}q_{\pm} < 0$. Let a number r be chosen so that $B(x)q_+ < 0$ for $x > r$, $B(x)q_- < 0$ for $x < -r$. Then if the vector-valued function $u(x)$ satisfies the inequality*

$$Lu \leq \alpha u \quad (\alpha \geq 0)$$

for $|x| \geq r$ and the conditions $u(\pm r) > 0$, $\lim u(x) \geq 0$ for $x \rightarrow \pm\infty$, then $u(x) \geq 0$ for $|x| \geq r$.

PROOF. We limit ourselves to the case $x \geq r$. For $x \leq -r$ the proof is analogous.

We assume that for $x > r$ the vector-valued function $u(x)$ is not nonnegative. Consider the vector-valued function $v(x) = u(x) + \tau q_+$. We can select $\tau > 0$, such that $v(x) \geq 0$, but not strictly positive. This follows from the fact that function $u_k(x)$, $k = 1, \dots, n$, if it takes on negative values, attains its smallest value at a

finite point. For example, let $v_1(x_0) = 0$ for $x_0 > r$. Function $v_1(x)$ satisfies the inequality

$$a_1(x)v_1'' + c_1(x)v_1' + \sum_k b_{1k}v_k(x) < \alpha v_1(x).$$

When $x = x_0$ we obtain a contradiction in signs. \square

LEMMA 5.4. *Under the conditions of Lemma 5.3 a bounded solution u of the problem*

$$Lu = \alpha u, \quad u(r) = 0 \quad (u(-r) = 0)$$

for $x > r$ ($x < -r$) is identically equal to zero.

PROOF. We consider the case $x > r$. For $x < -r$ the proof is similar. Assume at first that $u(\infty) = 0$. Then, applying Lemma 5.3 to the functions $u(x)$ and $-u(x)$, we find that $u(x) \equiv 0$ for $x > r$.

In the general case, we consider the function $\tilde{u}(x) = u(x)\exp(-\varepsilon x)$, $\varepsilon > 0$. Then $\tilde{u}(x)$ is a solution of the problem

$$(5.5) \quad \tilde{L}\tilde{u} = \alpha\tilde{u}, \quad \tilde{u}(r) = 0, \quad \tilde{u}(+\infty) = 0,$$

where $\tilde{L}\tilde{u} = A\tilde{u}'' + \tilde{C}\tilde{u}' + \tilde{B}\tilde{u}$, $\tilde{B} = A\varepsilon^2 + C\varepsilon + B$, $\tilde{C} = 2A\varepsilon + C$. It is obvious that for ε sufficiently small, $\tilde{B}(x)q_+ < 0$ for $x > r$.

Applying to problem (5.5) the result obtained above, we have $\tilde{u}(x) \equiv 0$. \square

PROOF OF THEOREM 1.1. 1. We consider first the case when, in equation (5.2), $\lambda = \alpha + i\beta$, $\alpha \geq 0$, $\beta \neq 0$. Suppose that a solution $u(x) = u^1(x) + iu^2(x)$ of this equation, different from zero, exists. We consider the Cauchy problem

$$\frac{\partial v}{\partial t} = Lv - \alpha v, \quad v(x, 0) = u^1(x).$$

The function

$$v(x, t) = u^1(x) \cos \beta t - u^2(x) \sin \beta t$$

is a solution of this problem. We let $\hat{u}(x) = (|u_1(x)|, \dots, |u_n(x)|)$, where $(u_1, \dots, u_n) = u$, and we select number $r > 0$ as indicated in Lemma 5.3. This can be done on the basis of Lemma 5.1. Further, we select $\tau > 0$ so that

$$(5.6) \quad \hat{u}(x) \leq \tau w(x) \quad \text{for} \quad |x| \leq r,$$

where for at least one k and one $|x_0| \leq r$ we have the equality

$$(5.7) \quad |u_k(x_0)| = \tau w_k(x_0).$$

On semi-axis $x \geq r$ we consider the problem

$$(5.8) \quad \frac{\partial y}{\partial t} = Ly - \alpha y, \quad y(r, t) = \hat{u}(r), \quad y(\infty, t) = 0,$$

$$(5.9) \quad y(x, 0) = \hat{u}(x),$$

and the stationary problem corresponding to it,

$$(5.10) \quad L\bar{y} - \alpha\bar{y} = 0, \quad \bar{y}(r) = \hat{u}(r), \quad \bar{y}(\infty) = 0.$$

On the basis of Lemma 5.4 the corresponding homogeneous problem has only the zero solution. By virtue of the conditions on matrix B_+ , the operator L considered

in the space $C_0(r, \infty)$, has the Fredholm property (see [Hen 1]). Therefore, a solution $\bar{y}(x) \in C_0(r, \infty)$ of problem (5.10) exists.

We show that the solution of problem (5.8), (5.9) converges to $\bar{y}(x)$ as $t \rightarrow \infty$. Indeed, the solution $y^*(x, t)$ of problem (5.8) with the initial condition $y(x, 0) = \tau_1 q_+$, where τ_1 is such that $\tau_1 q_+ > \hat{u}(x)$ for $x > r$, decreases monotonically with respect to t , and the solution $y_*(x, t)$ of problem (5.8) with the initial condition $y(x, 0) = 0$ increases monotonically. Since $y^*(x, t)$ and $y_*(x, t)$ converge as $t \rightarrow \infty$ to a bounded stationary solution, then, by virtue of Lemma 5.4,

$$\lim y_*(x, t) = \lim y^*(x, t) = \bar{y}(x) \quad \text{as } t \rightarrow \infty.$$

Further, from the comparison theorem for monotone systems (see §5.4 of Chapter 5), we conclude that

$$y_*(x, t) \leq y(x, t) \leq y^*(x, t),$$

and, therefore, as $t \rightarrow \infty$ we have

$$\lim y(x, t) = \bar{y}(x).$$

Since $v(x, t) \leq \hat{u}(x)$ for $x \geq r$, it then follows from the comparison theorem that

$$v(x, t) \leq y(x, t) \quad \text{for } x \geq r, \quad t \geq 0.$$

From this we have

$$v(x, t) = v(x, t + 2\pi n/\beta) \leq y(x, t + 2\pi n/\beta),$$

and, passing to the limit as $n \rightarrow \infty$, we obtain

$$v(x, t) \leq \bar{y}(x) \quad \text{for } x \geq r, \quad t \geq 0.$$

It follows from Lemma 5.3 applied to the function $\tau w(x) - \bar{y}(x)$, that $\bar{y}(x) \leq \tau w(x)$ for $x \geq r$, whence

$$(5.11) \quad v(x, t) \leq \tau w(x)$$

for $x \geq r, t \geq 0$. In a similar way we may prove this inequality for $x \leq -r$. The validity of inequality (5.11) for all x follows from this and from (5.6).

Function $z = \tau w - v \geq 0$ is a solution of the equation $\dot{z} = Lz - az + a\tau w$ ($\dot{z} = \partial z/\partial t$), and therefore its k th element $z_k(x, t)$ satisfies the inequality

$$\dot{z}_k \geq a_k(x)z_k'' + c_k(x)z_k' + b_{kk}(x)z_k - \alpha z_k.$$

Since $z_k(x, t) \geq 0$, is not identically equal to zero, and is periodic in t , it then follows from the theorem concerning strict positiveness of solutions of parabolic equations (see Chapter 1) that $z_k(x, t) > 0$ for all x and $t > 0$. But this contradicts equation (5.7). Indeed, we select t such that $|u_k(x_0)|^{-1}u_k(x_0) = \exp(-i\beta t)$. Then, obviously, $z_k(x_0, t) = \tau w_k(x_0) - |u_k(x_0)| = 0$. The resulting contradiction establishes the theorem for nonreal λ .

Assume now that $\lambda \geq 0$ is real and that $u(x)$ is a solution of equation (5.2), not identically equal to zero. We assume that at least one of the elements of the vector-valued function $u(x)$ takes on negative values. In the contrary case we could change the sign of $u(x)$. We consider the vector-valued function $v = u + \tau w$ and

we select $\tau > 0$ so that $v(x) \geq 0$ for $|x| \geq r$ but not strictly positive, i.e., $v_k(x_0) = 0$ for some k and x_0 . We have

$$(5.12) \quad Lv = \lambda v - \lambda \tau w,$$

and therefore $v(x) \geq 0$ on the whole axis by virtue of Lemma 5.3. If $\lambda > 0$, then for $x = x_0$, the k th equation of system (5.12) leads to a contradiction in signs. This contradiction shows that equation (5.2) cannot have solutions different from zero for $\lambda > 0$.

2. For $\lambda = 0$ function $v(x)$ defined above is a nonnegative, but not strictly positive, solution of equation $Lv = 0$. By virtue of Lemma 5.2, $v(x) \equiv 0$. If condition (5.1) is not satisfied, then this leads to a contradiction as $x \rightarrow \infty$. Thus, in this case, a nonzero solution of equation (5.2) does not exist.

Let condition (5.1) be satisfied. Then $v(x) \equiv 0$ implies the validity of assertion 2 of the theorem.

3. When condition (5.1) is satisfied, equation (5.3), by virtue of the Fredholm theorems, which apply in this case, has a solution v , which is different from zero and is unique to within a constant factor; and for solvability of the equation

$$(5.13) \quad Lu = f, \quad u(\pm\infty) = 0,$$

for $f \in L^2(-\infty, +\infty)$, it is necessary and sufficient that

$$(5.14) \quad \int_{-\infty}^{+\infty} (f, v) dx = 0.$$

Further, we note that if $v(x) \geq 0$, then, on the basis of Lemma 5.2, applied to equation (5.3), we have $v(x) > 0$. Therefore, if we assume that a positive solution of this equation does not exist, the solution is then of alternating sign and we can find a smooth function $f(x) \in L^2(-\infty, \infty)$, $f(x) < 0$, satisfying condition (5.14). Let $u(x)$ be the corresponding solution of equation (5.13). There exists a τ (not necessarily positive), such that $\tilde{u}(x) = u(x) + \tau w(x) \geq 0$ for $|x| < r$, but not strictly positive. By virtue of Lemma 5.3, $\tilde{u}(x) \geq 0$ on the whole axis. At points where the elements of the vector-valued function $\tilde{u}(x)$ vanish, this leads to a contradiction in signs in the equation $L\tilde{u} = f$, which completes the proof of the third assertion of the theorem. This completes the proof of the theorem. \square

Stability and Approach to a Wave

One of the most frequently encountered methods for studying the stability of stationary solutions of nonlinear evolutionary systems is the method of infinitely small perturbations of a stationary solution. As the result of linearization of the initial equations we arrive at a problem concerning the spectrum of a differential operator (we denote it by L) and thus to the necessity of solving two problems: first, how is the spectrum of operator L located, and, second, what can be said concerning stability or instability of a stationary solution, given the structure of the spectrum? For the case in which the domain of variation of the spatial variables is bounded (and the system itself satisfies certain conditions, that are usually satisfied in applied problems), the spectrum of operator L consists of a discrete set of eigenvalues, and the stationary solution will be stable if all the eigenvalues have negative real parts (i.e., lie in the left half of the complex plane) and unstable if at least one eigenvalue has a positive real part.

A significantly more complicated situation arises in considering the stability of traveling waves. In this case, owing to the unboundedness of the domain of variation of the spatial variables, the spectrum of operator L includes not only discrete eigenvalues, but also a continuous spectrum. Moreover, operator L can have a zero eigenvalue (this is related to the invariance of a traveling wave with respect to translation). Nevertheless, it proves to be the case that a linear analysis allows us to draw conclusions not only about stability or instability of a traveling wave, but also about the form of the stability: in some problems there is ordinary asymptotic stability (with an exponential estimate for the decay of perturbations), while in others there is stability with shift.

Stability with shift means that if the initial condition of the Cauchy problem for the system of equations

$$\frac{\partial u}{\partial t} = A \frac{\partial^2 u}{\partial x^2} + c \frac{\partial u}{\partial x} + F(u)$$

is close to a wave $w(x)$ in some norm, then the solution tends towards the wave $w(x+h)$ in this norm, where h is a number whose magnitude depends on the choice of the initial conditions. Stability with shift arises due to the invariance of solutions with respect to translation and the presence of a zero eigenvalue. The stability of a traveling wave as a stationary solution of a system of differential equations was studied in the case of a single spatial variable in [Sat 1], where a proof was given of a conditional theorem concerning stability: it was assumed that the entire spectrum of operator L , except a simple zero eigenvalue, lies in the left half-plane. In the present chapter we consider a problem of a more general form than that in [Sat 1] (for example, in §2 we consider systems with three spatial variables, varying in an unbounded cylinder). Moreover, the results presented in Chapter 4 allow us

to clarify the location of the continuous spectrum, so that the theorem concerning stability is of a less conditional nature; also, sufficient conditions for instability can be formulated, conditions associated with the presence of a continuous spectrum in the right half-plane.

In §1 we consider a differential equation in a Banach space, having a single-parameter family of stationary solutions φ_α , $-\bar{\alpha} < \alpha < \bar{\alpha}$. We prove stability with shift for a stationary solution φ_0 in the case where the spectrum of operator L contains a simple zero eigenvalue and all the remaining points of the spectrum lie in the left half-plane (Theorem 1.1). Consideration of abstract equations in a Banach space, and not of partial differential equations, allows us, on the one hand, to single out the essential property which leads to stability with shift (namely, the existence of a whole family of stationary solutions φ_α and the fact that $d\varphi_\alpha/d\alpha$ belongs to the considered space of initial perturbations), and, on the other hand, to the fact that such consideration can be extended to various problems in partial derivatives.

The next section is devoted to an application of the results obtained in §1 for studying the stability of a one-dimensional traveling wave with respect to one-dimensional and multi-dimensional perturbations. Results obtained in Chapter 4 have made it possible to determine a method for obtaining the continuous spectrum. Its disposition depends, generally speaking, on which space of initial perturbations of the traveling wave is regarded. In a number of problems, as this space we have to select weighted spaces with a specified exponential decrease of the initial perturbations at infinity (otherwise, the continuous spectrum will lie in the right half-plane, and the initial perturbations, not decreasing sufficiently rapidly at infinity, can lead to the development of an instability). Use of the results from Chapter 4 makes it possible to formulate Conditions II and III (§2), stipulating the absence of a continuous spectrum in the right half-plane. The problem concerning the type of stability is solved depending on whether or not the derivative of the stationary solution (being the eigenfunction corresponding to a zero eigenvalue) belongs to the space in question (Theorems 2.1 and 2.2). At the close of the section the results obtained are illustrated by the case of a single equation with three spatial variables (the case of a single equation with one spatial variable was considered in [Sat 2]).

Instability of traveling waves is discussed in §3.

For the case in which the system considered is monotone, it is shown in §4 that we have stability of monotone waves.

§5 is of an auxiliary nature: here we prove a series of theorems concerning the solutions of nonstationary problems, which are used for the study of waves and convergence to waves.

The question of nonlocal stability is examined in §6.

§7 is devoted to a minimax representation of the speed. It is placed in this chapter since results related to stability are used in the proofs.

§1. Stability with shift and its connection with the spectrum

In Banach space E we consider the equation

$$(1.1) \quad \frac{du}{dt} = Au + f(u).$$

Here $u(t) \in E$ for all $t \in [0, \infty)$; A and f are linear and nonlinear operators, respectively, acting in E .

Assume that the stationary equation

$$(1.2) \quad Au + f(u) = 0$$

has a single-parameter family of solutions $u = \varphi_\alpha \in E$, where α is a real parameter varying on the interval $(-\bar{\alpha}, \bar{\alpha})$.

In this section we study the stability of stationary solutions with respect to small perturbations from an arbitrary Banach space H , lying in E . We introduce the following notation: $\|z\|$ is the norm of element z of space H ; $[H, H]$ is the space of linear bounded operators acting from H into H ; $\|L\|$ is the norm of operator L as an element of the space $[H, H]$.

Let us assume that the following assumptions are satisfied for φ_α , $f(u)$, and A .

ASSUMPTION I. a) *The derivative φ'_α of the stationary solution φ_α with respect to α , $\alpha \in (-\bar{\alpha}, \bar{\alpha})$, exists, the derivative being taken in the norm of space H , $\varphi'_\alpha \in H$. (We do not assume that $\varphi_\alpha \in H$.)*

b) *φ'_α satisfies a Lipschitz condition with respect to α , $\alpha \in (-\bar{\alpha}, \bar{\alpha})$, in the norm of space H .*

ASSUMPTION II. a) *Nonlinear operator $f(u)$ is defined on all of E , is bounded, and has a first Gateaux differential $f'(u, v)$ with respect to an arbitrary direction v in space E ; $u, v, f'(u, v) \in E$.*

b) *The Gateaux differential $f'(u, v)$ is continuous with respect to $u \in E$ for arbitrary fixed $v \in E$. (It follows from this that $f'(u, \cdot) \in [E, E]$. To emphasize this, we shall write $f'(u)v$ instead of $f'(u, v)$.)*

c) *Operator $f'(\varphi_\alpha + v)$ belongs to $[H, H]$ for $v \in H$, $\alpha \in (-\bar{\alpha}, \bar{\alpha})$, and satisfies a Lipschitz condition with respect to v for $\|v\| \leq 1$.*

ASSUMPTION III. a) *The restriction of operator A , acting in H and being the generator of an analytic semigroup, exists (we retain the notation A for it). From Assumptions II c) and III a) it follows that operator $L = A + f'(\varphi_0)$ acts from H into H and is a generator of an analytic semigroup.*

b) *Spectrum $\sigma(L)$ of operator L has the following structure: zero is a simple eigenvalue; all the remaining spectrum is contained in a closed angle lying in the left half of the complex plane, i.e., there exist positive numbers a_1 and b_1 , such that for $\lambda \in \sigma(L)$, $\lambda \neq 0$, we have the inequality*

$$(1.3) \quad \operatorname{Re} \lambda + a_1 |\operatorname{Im} \lambda| + b_1 \leq 0.$$

The main result of this section is the following theorem.

THEOREM 1.1. *Assume that Assumptions I–III are satisfied. Then there exists a positive number ε , such that for an arbitrary $\bar{u} \in E$, satisfying the condition $\|\bar{u} - \varphi_0\| \leq \varepsilon$, the solution $u(t)$ of equation (1.1), with initial condition $u(0) = \bar{u}$, exists in space E for all $t \in [0, \infty]$, is unique, and for some $\alpha \in (-\bar{\alpha}, \bar{\alpha})$, obeys the estimate*

$$(1.4) \quad \|u(t) - \varphi_\alpha\| \leq M \exp(-bt),$$

where b and M do not depend on \bar{u} , α , and t , $b > 0$.

REMARK. In the statement of the theorem we assume that $\bar{u} - \varphi_0 \in H$, but we do not assume that $\bar{u}, \varphi_0 \in H$.

To prove this theorem we require the following series of lemmas.

LEMMA 1.1. *Let*

$$(1.5) \quad G(\varphi_\alpha, z) = f(\varphi_\alpha + z) - f(\varphi_\alpha) - f'(\varphi_\alpha)z.$$

Let φ_0 and f satisfy Assumptions I and II.

- a) Let $\|z\| \leq 1$. Then $G(\varphi_\alpha, z) \in H$.
- b) Let $\|z\| \leq 1$. Then $\|G(\varphi_\alpha, z)\| \leq c\|z\|^2$, where the constant c is independent of z and α .
- c) Let $\|z_1\|, \|z_2\| \leq 1$. Then

$$\|G(\varphi_\alpha, z_1) - G(\varphi_\alpha, z_2)\| \leq c(\|z_1\| + \|z_2\|)\|z_1 - z_2\|,$$

where constant c is independent of z_1, z_2 , and α .

- d) Let $\|z\| \leq 1/2$ and $|\alpha_1 - \alpha_2| \leq (2 \sup_\alpha \| \varphi'_\alpha \|)^{-1}$. Then

$$\|G(\varphi_{\alpha_1}, z) - G(\varphi_{\alpha_2}, z)\| \leq c\|z\|\|\alpha_1 - \alpha_2\|,$$

where constant c is independent of α_1, α_2 , and z .

PROOF. a) By virtue of Assumption II c) operator $f'(\varphi_\alpha + \tau z) \in [H, H]$ and is continuous with respect to τ for $\tau \in [0, t]$ in the norm of the space $[H, H]$. Therefore

$$(1.6) \quad f(\varphi_\alpha + z) - f(\varphi_\alpha) = \int_0^1 f'(\varphi_\alpha + \tau z)z \, d\tau$$

and, consequently, $G(\varphi_\alpha, z) \in H$.

b) By virtue of equation (1.6) and Assumption II c), we have

$$(1.7) \quad G(\varphi_\alpha, z) = \int_0^1 [f'(\varphi_\alpha + \tau z) - f'(\varphi_\alpha)]z \, d\tau,$$

$$(1.8) \quad \|G(\varphi_\alpha, z)\| \leq \int_0^1 \|f'(\varphi_\alpha + \tau z) - f'(\varphi_\alpha)\| \, d\tau \|z\| \leq 2c \int_0^1 \tau \, d\tau \|z\|^2.$$

c) By virtue of (1.7), we have

$$\begin{aligned} G(\varphi_\alpha, z_1) - G(\varphi_\alpha, z_2) &= \int_0^1 [f'(\varphi_\alpha + \tau z_1) - f'(\varphi_\alpha)] \, d\tau (z_1 - z_2) \\ &\quad + \int_0^1 [f'(\varphi_\alpha + \tau z_1) - f'(\varphi_\alpha + \tau z_2)] \, d\tau z_2. \end{aligned}$$

Making an estimate similar to (1.8), we obtain the assertion of the lemma.

d) By virtue of (1.6), we have

$$G(\varphi_{\alpha_1}, z) - G(\varphi_{\alpha_2}, z) = \int_0^1 [f'(\varphi_{\alpha_1} + \tau z) - f'(\varphi_{\alpha_2} + \tau z)] d\tau z - [f'(\varphi_{\alpha_1}) - f'(\varphi_{\alpha_2})]z.$$

By virtue of Assumptions I and II c), we have

$$\begin{aligned} \|G(\varphi_{\alpha_1}, z) - G(\varphi_{\alpha_2}, z)\| &\leq \int_0^1 \|f'(\varphi_{\alpha_1} + \tau z) - f'(\varphi_{\alpha_2} + \tau z)\| d\tau \|z\| \\ &\quad + \|f'(\varphi_{\alpha_1}) - f'(\varphi_{\alpha_2})\| \cdot \|z\| \\ &\leq c_1 \|\varphi_{\alpha_1} - \varphi_{\alpha_2}\| \cdot \|z\| \\ &\leq c_1 \sup_{\alpha} \|\varphi'_{\alpha}\| \cdot |\alpha_1 - \alpha_2| \cdot \|z\| \leq c|\alpha_1 - \alpha_2| \cdot \|z\|. \quad \square \end{aligned}$$

LEMMA 1.2. Consider the operator $A + f'(\varphi_{\alpha})$, acting from H into H . Assume that Assumptions I–III are satisfied and that $|\alpha| \leq \gamma$, where γ is a sufficiently small positive number. Then

a) Zero is a simple eigenvalue of operator $A + f'(\varphi_{\alpha})$ with eigenfunction φ'_{α} .

All the remaining points of the spectrum $\sigma(A + f'(\varphi_{\alpha}))$ of operator $A + f'(\varphi_{\alpha})$ are contained in a closed angle lying in the left half of the complex plane \mathbb{C} ; more precisely, if $\lambda \in \sigma(A + f'(\varphi_{\alpha}))$, $\lambda \neq 0$, then

$$\operatorname{Re} \lambda + a_2 |\operatorname{Im} \lambda| + b_2 \leq 0,$$

where a_2 and b_2 are positive constants independent of α .

b) Operator $A + f'(\varphi_{\alpha})$ generates an analytic semigroup $U_{\alpha}(t)$. The semigroup $U_{\alpha}(t)$ is representable in the form $U_{\alpha}(t) = V_{\alpha}(t) + P_{\alpha}$, where $\|V_{\alpha}(t)\| \leq M_1 \exp(-dt)$ (M_1 and d are independent of α and t ; d is an arbitrary number less than b_2) and P_{α} is an operator of projection onto the kernel of operator $A + f'(\varphi_{\alpha})$, i.e., onto the one-dimensional subspace generated by φ'_{α} .

Operator P_{α} satisfies a Lipschitz condition with respect to α . We have the estimate

$$\|V_{\alpha_1}(t) - V_{\alpha_2}(t)\| \leq c \exp(-dt) |\alpha_1 - \alpha_2|,$$

where constant c is independent of α_1 , α_2 , and t .

c) Functional Φ_{α} , acting on H and defined by the equation $(\Phi_{\alpha} z) \varphi'_{\alpha} = P_{\alpha} z$ ($z \in H$), satisfies a Lipschitz condition with respect to α .

PROOF. a) We show first that φ'_{α} satisfies the equation

$$(1.9) \quad (A + f'(\varphi_{\alpha}))\varphi'_{\alpha} = 0.$$

(We cannot differentiate equation (1.2) (in which φ_{α} replaces u) directly with respect to α to obtain (1.9) since operator A is unbounded.)

Let λ_0 be a regular point of operator A . Then letting $R = (A - \lambda_0 I)^{-1}$ ($R: H \rightarrow H$), we have

$$\begin{aligned} (A - \lambda_0)(\varphi_\alpha - \varphi_0) + \lambda_0(\varphi_\alpha - \varphi_0) + f(\varphi_\alpha) - f(\varphi_0) &= 0, \\ \varphi_\alpha - \varphi_0 + \lambda_0 R(\varphi_\alpha - \varphi_0) + R[f(\varphi_\alpha) - f(\varphi_0)] &= 0. \end{aligned}$$

Differentiating with respect to α , we obtain

$$\varphi'_\alpha + \lambda_0 R\varphi'_\alpha + Rf'(\varphi_\alpha)\varphi'_\alpha = 0, \quad (A - \lambda_0)\varphi'_\alpha + \lambda_0\varphi'_\alpha + f'(\varphi_\alpha)\varphi'_\alpha = 0,$$

from which (1.9) follows.

In the complex plane we consider a circle Γ with center at the origin and of radius $b_1/2$. (By virtue of Assumption III b) all the points of circle Γ are regular points of operator $A + f'(\varphi_0)$.) Since for sufficiently small γ the norm of operator $f'(\varphi_\alpha) - f'(\varphi_0) \in [H, H]$ is small and operator $A + f'(\varphi_0)$ has one simple eigenvalue inside Γ , then operator $A + f'(\varphi_0) + [f'(\varphi_\alpha) - f'(\varphi_0)]$ also has one simple eigenvalue inside Γ (see [Gokh 1]). Taking (1.9) into account, we find that zero is a simple eigenvalue of operator $A + f'(\varphi_\alpha)$ and all the remaining points inside Γ are regular points.

Since operator $A + f'(\varphi_\alpha)$ generates an analytic semigroup, its spectrum then lies in the angle

$$\operatorname{Re} \lambda + a_3 |\operatorname{Im} \lambda| - b_3 \leq 0$$

($a_3, b_3 > 0$). On the other hand, for an arbitrary compact domain of the complex plane, not containing the spectrum of operator $A + f'(\varphi_0)$, the number γ can be chosen so small that all the points of this domain will be regular points of operator $A + f'(\varphi_\alpha)$ for $|\alpha| \leq \gamma$. The assertion of the lemma then follows from this.

b) The semigroup $U_\alpha(t)$ generated by the operator $A + f'(\varphi_\alpha)$ can be represented in the form

$$U_\alpha(t) = \int_{\Pi} \exp(\lambda t) R_\alpha(\lambda) d\lambda, \quad R_\alpha(\lambda) \equiv (A + f'(\varphi_\alpha) - \lambda I)^{-1},$$

$\Pi = \{\lambda \in \mathbb{C}: \operatorname{Re} \lambda + a_4 |\operatorname{Im} \lambda| - b_4 \leq 0, a_4, b_4 > 0, \text{ and do not depend on } \alpha\}$. Here $R_\alpha(\lambda)$ is the resolvent of operator $A + f'(\varphi_\alpha)$; contour Π is traversed in the positive direction. Taking into account the analyticity of $R_\alpha(\lambda)$ with respect to λ for $\lambda \notin \sigma(A + f'(\varphi_\alpha))$ and an estimate for the resolvent, we have

$$U_\alpha(t) = V_\alpha(t) + P_\alpha, \quad V_\alpha(t) \equiv \int_{\Pi'} \exp(\lambda t) R_\alpha(\lambda) d\lambda,$$

$$P_\alpha \equiv \int_{\Gamma} \exp(\lambda t) R_\alpha(\lambda) d\lambda, \quad \Pi' = \{\lambda \in \mathbb{C}: \operatorname{Re} \lambda + a_5 |\operatorname{Im} \lambda| + d = 0\}.$$

Here d is an arbitrary number smaller than b_2 ; $a_5 > 0$; and a_5 and d are independent of α . An estimate of $\|V_\alpha(t)\|$ is made directly, while $P_\alpha = \int_{\Gamma} R_\alpha(\lambda) d\lambda$ in view

of the analyticity of $(\exp(\lambda t) - 1)R_\alpha(\lambda)$ inside Γ . P_α is the operator of projection onto the kernel of operator $A + f'(\varphi_\alpha)$ (see [Gokh 1]). We have

$$P_{\alpha_1} - P_{\alpha_2} = \int_\Gamma R_{\alpha_2}(\lambda)(f'(\varphi_{\alpha_2}) - f'(\varphi_{\alpha_1}))R_{\alpha_1}(\lambda) d\lambda,$$

$$V_{\alpha_1}(t) - V_{\alpha_2}(t) = \int_{\Pi'} \exp(\lambda t)R_{\alpha_2}(\lambda)(f'(\varphi_{\alpha_2}) - f'(\varphi_{\alpha_1}))R_{\alpha_1}(\lambda) d\lambda.$$

Hence,

$$\|P_{\alpha_1} - P_{\alpha_2}\| \leq c_1 \|f'(\varphi_{\alpha_2}) - f'(\varphi_{\alpha_1})\| \leq c|\alpha_1 - \alpha_2|,$$

$$\|V_{\alpha_1}(t) - V_{\alpha_2}(t)\| \leq c_1 \exp(-dt) \|f'(\varphi_{\alpha_2}) - f'(\varphi_{\alpha_1})\| \leq c|\alpha_1 - \alpha_2| \exp(-dt).$$

c) Let ψ be a linear continuous functional on H such that $\psi\varphi'_0 = 1$. Then $\Phi_\alpha z \psi\varphi'_\alpha = \psi P_\alpha z$, $\Phi_\alpha = \psi P_\alpha / \psi\varphi'_\alpha$ (since, for sufficiently small γ , $\psi\varphi'_\alpha = 1 + \psi(\varphi'_\alpha - \varphi'_0) \neq 0$). Fulfillment of the Lipschitz condition for P_α and φ'_α with respect to α implies fulfillment of a Lipschitz condition for the functional Φ_α . \square

PROOF OF THEOREM 1.1. We consider the system of equations

(1.10)

$$z(t) = V_\alpha(t)(\bar{u} - \varphi_\alpha) + \int_0^t V_\alpha(t-s)G(\varphi_\alpha, z(s)) ds$$

$$- P_\alpha \int_t^\infty G(\varphi_\alpha, z(s)) ds \equiv \Lambda(\alpha, z),$$

$$\alpha = \Phi_\alpha(\bar{u} - \varphi_0) - \Phi_\alpha(\varphi_\alpha - \varphi_0 - \alpha\varphi'_\alpha)$$

(1.11)

$$+ \Phi_\alpha \int_0^\infty G(\varphi_\alpha, z(s)) ds \equiv h(\alpha, z)$$

(\bar{u} is an arbitrary element of space E such that $\|\bar{u} - \varphi_0\| \leq \varepsilon$; $G(\varphi_\alpha, z)$ was introduced in Lemma 1.1; and $V_\alpha(t)$, P_α , and Φ_α were introduced in Lemma 1.2). By a solution of system (1.10), (1.11) we mean a pair $(\alpha, z(t))$, where α is a number from the interval $(-\bar{\alpha}, \bar{\alpha})$ and $z(t)$ is a trajectory in H , continuous with respect to t ($z(t) \in H$ for $t \in [0, \infty)$), such that $\|z(t)\| \exp(bt)$ is bounded by a constant, independent of t for $t \in [0, \infty)$ (b is a number from the interval $(0, d)$); the condition of boundedness for $\|z(t)\| \exp(bt)$ makes it possible to assert existence of the integrals in (1.10), (1.11)).

We prove the existence of a solution of system (1.10), (1.11) by the contraction mapping method. Consider the set S of pairs $(\alpha, z(t))$:

$$S = \{(\alpha, z(t)) : \alpha \in (-\alpha_0, \alpha_0), \quad \|z(\cdot)\|_{b,\mu} \equiv \mu \sup_t e^{bt} \|z(t)\| \leq r,$$

$$z(t) \text{ is continuous with respect to } t\}.$$

Set S is a complete metric space with respect to the distance

$$\rho((\alpha_1, z_1(\cdot)), (\alpha_2, z_2(\cdot))) = |\alpha_1 - \alpha_2| + \|z_1(\cdot) - z_2(\cdot)\|_{b,\mu}.$$

We show that numbers ε , μ , α , and r can be chosen so that operator (h, Λ) takes S into itself and is a contraction operator. (Continuity of $\Lambda(\alpha, z)$ with respect to t is obvious.)

We have the following estimates (constant c is independent of ε , α_0 , r , and μ):

$$(1.12) \quad |h(\alpha, z)| \leq c \left(\varepsilon + \alpha_0^2 + \frac{r^2}{\mu^2} \right),$$

$$(1.13) \quad \|\Lambda(\alpha, z)\|_{b,\mu} \leq c \left(\varepsilon\mu + \alpha_0\mu + \frac{r^2}{\mu} \right),$$

$$(1.14) \quad \begin{aligned} |h(\alpha_1, z_1) - h(\alpha_2, z_2)| &\leq c \left(\varepsilon + \alpha_0^2 + \alpha_0 + \frac{r}{\mu} + \frac{r^2}{\mu^2} \right) |\alpha_1 - \alpha_2| \\ &\quad + c \frac{r}{\mu^2} \|z_1(\cdot) - z_2(\cdot)\|_{b,\mu}, \end{aligned}$$

$$(1.15) \quad \begin{aligned} \|\Lambda(\alpha_1, z_1) - \Lambda(\alpha_2, z_2)\|_{b,\mu} &\leq c \left(\varepsilon\mu + \alpha_0\mu + \mu + \frac{r^2}{\mu} + r \right) |\alpha_1 - \alpha_2| \\ &\quad + c \frac{r}{\mu} \|z_1(\cdot) - z_2(\cdot)\|_{b,\mu}. \end{aligned}$$

These estimates are obtained directly upon taking Lemmas 1.1 and 1.2 into account. For example, let us obtain the estimate (1.12). We have ($\|\cdot\|'$ indicates the norm of a functional over space H)

$$\begin{aligned} |h(\alpha, z)| &\leq \|\Phi_\alpha\|' \|\bar{u} - \varphi_0\| + \|\Phi_\alpha\|' \|\varphi_\alpha - \varphi_0 - \alpha\varphi'_\alpha\| + \|\Phi_\alpha\|' \int_0^\infty \|G(\varphi_\alpha, z(t))\| dt \\ &\leq c_1\varepsilon + c_2\alpha^2 + c_3 \int_0^\infty \|z(t)\|^2 dt \leq c_1\varepsilon + c_2\alpha^2 + \frac{c_4}{\mu^2} \|z(\cdot)\|_{b,\mu}^2 \int_0^\infty e^{-2bt} dt \\ &\leq c \left(\varepsilon + \alpha_0^2 + \frac{r^2}{\mu^2} \right). \end{aligned}$$

The other estimates are obtained in a similar way. It follows from estimates (1.12)–(1.15) that in order for operator (h, Λ) to take S into itself and be contractive it is necessary that the following conditions be satisfied:

$$(1.16) \quad \begin{aligned} \varepsilon\mu + \alpha_0\mu + \mu + \frac{r^2}{\mu} + r + \varepsilon + \alpha_0^2 + \frac{r}{\mu} + \frac{r^2}{\mu^2} &\leq \frac{1}{2c}, \\ \frac{r}{\mu} + \frac{r}{\mu^2} &\leq \frac{1}{2c}, \\ c \left(\varepsilon + \alpha_0^2 + \frac{r^2}{\mu^2} \right) &\leq \alpha_0, \\ c \left(\varepsilon\mu + \alpha_0\mu + \frac{r^2}{\mu} \right) &\leq r. \end{aligned}$$

This system of inequalities is solvable with respect to μ , ε , α_0 , and r . Indeed, taking μ to be an arbitrary number less than μ_0 , $r = \mu^3$, $\varepsilon = \mu^4$, $\alpha_0 = \mu^{5/2}$, we obtain a solution of system (1.16) ($\mu_0 = \min(1, (324c^2)^{-1}, \mu_1)$), where μ_1 is sufficiently small so that in deriving the estimates (1.12)–(1.15) we can apply the results of Lemmas 1.1 and 1.2).

Thus, we have proved the existence of a solution $(\alpha, z(t))$ of system (1.10), (1.11) and have obtained the estimate

$$(1.17) \quad \|z(t)\| \leq \frac{r}{\mu} e^{-bt}.$$

Equation (1.11) yields

$$\Phi_\alpha(\bar{u} - \varphi_\alpha) + \Phi_\alpha \int_0^\infty G(\varphi_\alpha, z(t)) dt = 0.$$

Therefore, using (1.10), we see that the solution $(\alpha, z(t))$ we obtained satisfies the equation

$$(1.18) \quad z(t) = U_\alpha(t)(\bar{u} - \varphi_\alpha) + \int_0^t U_\alpha(t-s)G(\varphi_\alpha, z(s)) ds.$$

It follows from (1.18) that $z(t)$ is a solution of the equation

$$\frac{dz}{dt} = Az + f(z + \varphi_\alpha) - f(\varphi_\alpha)$$

with initial condition $z(0) = \bar{u} - \varphi_\alpha$ (smoothness of $z(t)$ follows from (1.18)). Therefore, $u(t) = z(t) + \varphi_\alpha$ is a solution of equation (1.1) with initial condition $u(0) = \bar{u}$, and, by virtue of (1.17), we obtain (1.4) (where $M = r/\mu$).

Uniqueness of solution $u(t)$ of equation (1.1) may be proved by the usual methods. This completes the proof of the theorem. \square

In what follows, we require a theorem concerning stability for the case in which the stationary equation (1.2) has a unique solution φ_0 , and not an entire family of solutions φ_α . (By uniqueness, here, we mean the isolatedness of φ_0 from other stationary solutions, i.e., the absence of other stationary solutions in a sufficiently small ball $\|u - \varphi_0\| \leq \bar{\varepsilon}$, $u \in E$, $u - \varphi_0 \in H$.) Let us assume that Assumption II (in which we take $\alpha = 0$) and Assumption III a) are satisfied, and also that (1.3) is satisfied for all $\lambda \in \sigma(L)$. We then have the following theorem.

THEOREM 1.2. *There exists a positive number ε such that for arbitrary $\bar{u} \in E$ satisfying the condition $\|\bar{u} - \varphi_0\| \leq \varepsilon$ the solution $u(t)$ of equation (1.1), with initial condition $u(0) = \bar{u}$, exists in space E for all $t \in [0, \infty)$, is unique, and satisfies the estimate*

$$\|u(t) - \varphi_0\| \leq M e^{-bt},$$

where b is an arbitrary number less than b_1 , and M is independent of \bar{u} and t .

This result is well known and its proof is similar to that of Theorem 1.1.

§2. Stability of planar waves to spatial perturbations

In this section we apply the results obtained to the study of the stability of a one-dimensional traveling wave with respect to one-dimensional and multi-dimensional perturbations. In §2.1 we consider one-dimensional perturbations, small with respect to a uniform norm; in §2.2 we consider multi-dimensional perturbations in Sobolev spaces.

2.1. Stability in space C . We assume the existence of a traveling wave with speed c , and we consider the corresponding system of equations in coordinates connected with the wave front,

$$(2.1) \quad \frac{\partial u}{\partial t} = a \frac{\partial^2 u}{\partial x^2} + c \frac{\partial u}{\partial x} + F(u),$$

so that the traveling wave $w(x)$ is a stationary solution of this system. As usual, we assume that $w(x)$ is continuous, bounded, and has bounded continuous derivatives to the second order; we also assume existence of the limits

$$(2.2) \quad \lim_{x \rightarrow \pm\infty} w(x) = w_{\pm}.$$

As the space E , indicated in §1, we select the space C of vector-valued functions, defined on the entire axis \mathbb{R} , and continuous and bounded. We denote the norm in this space by $\| \cdot \|$:

$$(2.3) \quad \|u\| = \sup |u(x)| \quad \text{for } x \in \mathbb{R},$$

where $| \cdot |$ is the norm in the Euclidean space \mathbb{R}^n . As the space H , we select the space C_{σ} of vector-valued functions $u \in C$, such that

$$\lim u(x)(1 + e^{\sigma x}) = 0 \quad \text{as } |x| \rightarrow \infty,$$

where σ is a given nonnegative number. The norm in this space is given by

$$(2.4) \quad \|u\|_{\sigma} = \sup |u(x)(1 + e^{\sigma x})| \quad \text{for } x \in \mathbb{R}$$

(obviously, for $\sigma = 0$ norms (2.3) and (2.4) are equivalent).

Along with the real space C_{σ} we also consider a complex space C_{σ} , which is defined in exactly the same way as the real space. The elements of this latter space are complex vector-valued functions $u(x)$, while the norm is defined by equation (2.4), where $| \cdot |$ is the norm in the complex n -dimensional space. Transition to the complex space is necessary for the study of the spectrum of linearized problems. Nonlinear problems are considered in the real space.

We introduce operator L acting in the complex space C_{σ} and defined by the equation

$$(2.5) \quad Lu = au'' + cu' + F'(w)u,$$

where $F'(w)$ is the matrix of first derivatives of the vector-valued function $F(w)$ (the right-hand side in (2.5) is the result of linearizing the right-hand side of equation (2.1) on the wave w). As the domain of definition $D(L)$ of operator L we take the space C_{σ}^2 of all $u \in C_{\sigma}$, such that u' and u'' belong to C_{σ} .

We let $B(x) = F'(w(x))$ and

$$B_{\pm} = \lim B(x) \quad \text{as } x \rightarrow \pm\infty.$$

We now indicate how stability is to be understood.

DEFINITION 2.1. A wave $w(x)$ is said to be *asymptotically stable with shift* according to the norm $\| \cdot \|_{\sigma}$, if there exists a positive number ε such that for an arbitrary real vector-valued function $u_0(x) \in C$ with $u_0 - w \in C_{\sigma}$, $\|u_0 - w\|_{\sigma} < \varepsilon$,

the solution $u(x, t)$ of system (2.1) with initial condition $u(x, 0) = u_0(x)$ exists for all $t > 0$, is unique, $u(x, t) - w(x) \in C_\sigma$, and satisfies the estimate

$$\|u(x, t) - w(x + h)\|_\sigma \leq Me^{-bt},$$

where h is a number depending on $u_0(x)$; $M > 0$ and $b > 0$ are independent of t , h , and $u_0(x)$.

DEFINITION 2.2. A wave $w(x)$ is said to be *asymptotically stable* according to the norm $\| \cdot \|_\sigma$ if there exists a positive number ε such that for an arbitrary real vector-valued function $u_0(x) \in C$, with $u_0 - w \in C_\sigma$, $\|u_0 - w\|_\sigma \leq \varepsilon$, the solution $u(x, t)$ of system (2.1) with initial condition $u(x, 0) = u_0(x)$ exists for all $t > 0$, is unique, $u(x, t) - w(x) \in C_\sigma$, and satisfies the estimate

$$\|u(x, t) - w(x)\|_\sigma \leq Me^{-bt},$$

where $M > 0$ and $b > 0$ are independent of t and $u_0(x)$.

Stability in the sense of Definition 2.2 is the usual asymptotic (and even exponential) stability in the Lyapunov sense.

We now formulate conditions under which stability will be proved.

CONDITION 1. The derivative $w'(x)$ belongs to the space C_σ and operator L has a simple zero eigenvalue, and no other eigenvalues with a nonnegative real part.

CONDITION 1'. The derivative $w'(x)$ does not belong to the space C_σ and all the eigenvalues of operator L have negative real parts.

CONDITION 2. For arbitrary real ξ all eigenvalues of the matrix

$$-a\xi^2 + B_-$$

have negative real parts.

CONDITION 3. For arbitrary real ξ all eigenvalues of the matrix

$$a(i\xi - \sigma)^2 + (B_+ - \sigma c)$$

have negative real parts.

A theorem concerning stability may be stated as follows.

THEOREM 2.1. *Suppose that Conditions 1, 2, and 3 are satisfied. Then wave $w(x)$ is asymptotically stable with shift according to the norm $\| \cdot \|_\sigma$.*

Suppose that Conditions 1', 2, 3, are satisfied. Then wave $w(x)$ is asymptotically stable according to the norm $\| \cdot \|_\sigma$.

The proof of this theorem is based on the use of results from §1. It will be presented below. As a preliminary step, we consider properties of operator L in the space C_σ .

We introduce operator $T: Tu = (1 + e^{\sigma x})u$, acting from space C_σ to space C_0 . Obviously, it is defined over all of C_σ , is bounded, and has a bounded inverse defined on all of C_0 : $T^{-1}u = (1 + e^{\sigma x})^{-1}u$.

It is easy to verify that

$$(2.6) \quad T^{-1}C_0^2 = C_\sigma^2.$$

We consider next the operator

$$(2.7) \quad \tilde{L} = TLT^{-1}.$$

This operator acts in C_0 and has the domain of definition C_0^2 . Operator \tilde{L} can be written in explicit form: for $v \in C_0^2$

$$(2.8) \quad \tilde{L}v = av'' + (c - 2g_1a)v' + [g_2a - g_1c + B(x)]v,$$

where

$$(2.9) \quad g_1 = \frac{\sigma e^{\sigma x}}{1 + e^{\sigma x}}, \quad g_2 = \frac{\sigma^2 e^{\sigma x} (e^{\sigma x} - 1)}{(1 + e^{\sigma x})^2}.$$

LEMMA 2.1. *Operator L has a dense domain of definition. For $\operatorname{Re} \lambda > k$, where k is a sufficiently large number, operator $(\lambda - L)^{-1}$ exists, is defined on all of C_σ , and satisfies the estimate*

$$(2.10) \quad \|(\lambda - L)^{-1}\|_\sigma \leq \frac{c}{1 + |\lambda|},$$

where c is a positive constant.

PROOF. We show first that operator L has a dense domain of definition, i.e., that C_σ^2 is dense in C_σ . Let $u \in C_\sigma$ and $v = Tu \in C_0$. Let

$$v_\rho(x) = \int_{-\infty}^{+\infty} \omega_\rho(x - y)v(y) dy,$$

where $\omega_\rho(x)$ is a twice continuously differentiable averaging kernel. It is readily verified that $v_\rho(x) \in C_0^2$ and that for arbitrary $\varepsilon > 0$ there exists a ρ so small that $\|v - v_\rho\| < \varepsilon$. Let $u_\rho = T^{-1}v_\rho$. Then, from (2.6), $u_\rho \in C_\sigma^2$ and we have the estimate

$$\|u - u_\rho\|_\sigma = \|T^{-1}v - T^{-1}v_\rho\|_\sigma \leq \|v - v_\rho\| < \varepsilon.$$

We conclude from this that C_σ^2 is dense in C_σ .

It follows from (2.7) that operator

$$(2.11) \quad \tilde{L} - \lambda = T(L - \lambda)T^{-1}$$

has an inverse, defined on all of C_0 .

We consider first the principal term of this operator $(\tilde{L}_0 - \lambda)v = av'' - \lambda v$. The solution of the equation

$$av'' - \lambda v = f(x) \quad (f(x) \in C_0)$$

can be written explicitly for $\text{Re } \lambda > 0$:

$$v(x) = \int_{-\infty}^{+\infty} \Gamma(x-y)f(y) dy,$$

where

$$\Gamma(x) = -1/2\sqrt{\lambda^{-1}a^{-1}} \exp(-\sqrt{\lambda a^{-1}}|x|),$$

which may be verified directly by substitution. It is easy to see that $u(x) \in C_0^2$, and we have the estimate

$$(2.12) \quad \begin{aligned} |v(x)| &\leq K \|f\| |\lambda|^{-1/2} \int_{-\infty}^{+\infty} \exp(-\text{Re } \sqrt{\lambda} \mu_1 |x-y|) dy \\ &= 2K \|f\| |\lambda|^{-1/2} (\text{Re } \sqrt{\lambda} \mu_1)^{-1}. \end{aligned}$$

Here K is a positive constant; μ_1 is the minimal eigenvalue of the matrix $\sqrt{a^{-1}}$. For $\text{Re } \lambda > 0$, $\sqrt{\lambda}$ lies in the angle $|\text{Im } \lambda| \leq \text{Re } \lambda$, and, therefore, $\sqrt{|\lambda|} \leq 2 \text{Re } \sqrt{\lambda}$. From (2.12) we now obtain the estimate

$$(2.13) \quad \|v\| \leq K_1 |\lambda|^{-1} \|f\|, \quad \text{i.e., } \|(\tilde{L}_0 - \lambda)^{-1}\| \leq K_1 |\lambda|^{-1} \quad (\text{Re } \lambda > 0).$$

Consider now the operator $\tilde{L} - \lambda = (\tilde{L}_0 - \lambda) + \tilde{L}_1$, where

$$\tilde{L}_1 v = (c - 2g_1 a)v' + [g_2 a - g_1 c + B(x)]v.$$

Using the estimate

$$(2.14) \quad \|v'\| \leq \delta \|v''\| + 2\delta^{-1} \|v\|,$$

where δ is an arbitrary positive number (see the Remark), we obtain

$$(2.15) \quad \|\tilde{L}_1 v\| \leq \varepsilon \|\tilde{L}_0 v\| + c_\varepsilon \|v\|,$$

where ε is an arbitrary number, which may be chosen sufficiently small, and c_ε is a positive constant depending on ε .

The equation

$$(\tilde{L} - \lambda)v = f \quad (f \in C_0)$$

can obviously be written in the form

$$(2.16) \quad [I + \tilde{L}_1(\tilde{L}_0 - \lambda)^{-1}](\tilde{L}_0 - \lambda)v = f.$$

For $\text{Re } \lambda > 0$, we have the following estimate, based on (2.15) and (2.13):

$$(2.17) \quad \begin{aligned} \|\tilde{L}_1(\tilde{L}_0 - \lambda)^{-1}\| &\leq \varepsilon \|\tilde{L}_0(\tilde{L}_0 - \lambda)^{-1}\| + c_\varepsilon \|(\tilde{L}_0 - \lambda)^{-1}\| \\ &\leq \varepsilon(1 + K_1) + c_\varepsilon K_1 |\lambda|^{-1}. \end{aligned}$$

Therefore, for sufficiently small ε and large $|\lambda|$, the operator $\tilde{L}_1(\tilde{L}_0 - \lambda)^{-1}$ has norm less than 1. Consequently, operator $I + \tilde{L}_1(\tilde{L}_0 - \lambda)^{-1}$ has a bounded inverse

in C_0 . This means that for these λ the equation (2.16) is solvable for an arbitrary right-hand side f . From (2.17) and (2.13) we also obtain the estimate

$$\|(\tilde{L} - \lambda)^{-1}\| \leq \|(\tilde{L}_0 - \lambda)^{-1}\| \cdot \|(I + \tilde{L}_1(\tilde{L}_0 - \lambda)^{-1})^{-1}\| \leq K_2|\lambda|^{-1}.$$

From (2.11) we now have a similar estimate for $(L - \lambda)^{-1}$, which, obviously, can be written in the form (2.10) for $|\lambda|$ sufficiently large. This completes the proof of the lemma. \square

REMARK. We present a proof for the estimate (2.14). Let v_k be the real or imaginary part of an arbitrary element of vector v , let x be an arbitrary point of the real axis, and let $[\alpha, \beta]$ be an arbitrary interval of length δ containing the point x . Then there exists a point $x_k \in [\alpha, \beta]$ such that $v'_k(x_k) = [v_k(\beta) - v_k(\alpha)]\delta^{-1}$.

Further, we have

$$v'_k(x) = \int_{x_k}^x v''_k(s) ds + v'_k(x_k),$$

whence

$$|v'_k(x)| \leq \int_{\alpha}^{\beta} |v''_k(s)| ds + \delta^{-1}(|v_k(\beta)| + |v_k(\alpha)|),$$

and, after simple manipulations,

$$|v'(x)| \leq \delta \|v''\| + 2\delta^{-1} \|v\|.$$

PROOF OF THE THEOREM. We prove the first assertion of the theorem. Proof of the second is similar (and even simpler). It is necessary for us to verify that Assumptions I–III, introduced in §1, are satisfied. Equation (2.1) can obviously be written in the form (1.1) in space C . The single-parameter family of solutions in the given case is $w(x + \alpha)$, where $w(x)$ is a traveling wave and α is an arbitrary real number. We shall not give the proof here of the fact that Assumptions I and II are satisfied, since this is elementary. We prove that Assumption III is satisfied. By the lemma, operator L is the generator of an analytic semigroup in space C_σ (a general theorem concerning the relationship between an estimate of the resolvent of an operator and the analyticity of a semigroup is given, for example, in [Kra 3]). It remains to consider the spectrum of operator L . We begin with the operator \tilde{L} . We note that for functions given by equation (2.9), we have

$$\begin{aligned} g_1(x) &\rightarrow 0, & g_2(x) &\rightarrow 0 & \text{as } x &\rightarrow -\infty, \\ g_1(x) &\rightarrow \sigma, & g_2(x) &\rightarrow \sigma^2 & \text{as } x &\rightarrow +\infty. \end{aligned}$$

Therefore, we obtain the following structure of the continuous spectrum of operator \tilde{L} (see [Hen 1, Vol 10], and Chapter 4). Let M be the union of the domains lying inside the curves described by the eigenvalues of the matrices

$$-a\xi^2 + (c - 2\sigma a)i\xi + (a\sigma^2 + c\sigma + B_+)$$

and $-a\xi^2 - ci\xi + B_-$ for $-\infty < \xi < +\infty$, and of the points of these curves themselves. Then the continuous spectrum of operator \tilde{L} is contained in M . But, by virtue of Conditions 2 and 3, these curves lie in the left half-plane, and, as is readily seen, at some positive distance from the imaginary axis. Moreover, as $\xi \rightarrow \pm\infty$, they behave asymptotically as parabolas. It follows from this that the continuous spectrum of operator \tilde{L} lies inside the angle (1.3), subject to suitable choice of a_1 and b_1 . In

addition, outside of this angle there is only a finite number of points of the discrete spectrum.

We return now to operator L . We conclude from (2.7) that the regular points of operators L and \tilde{L} coincide. It therefore follows for operator L also that its whole spectrum, except for a finite number of points, lies inside angle (1.3). But, by virtue of Condition 1, all the eigenvalues of operator L , with the exception of the point 0, lie in the left half-plane. Therefore, varying a_1 and b_1 , if necessary, we can contain the whole spectrum of operator L , with the exception of point 0, inside the indicated angle.

Thus we see that Assumptions I–III are satisfied for the case in question and, therefore, the first assertion of the theorem follows from the assertion of Theorem 1.1. \square

2.2. Stability in Sobolev spaces. In this section we apply results obtained in §1 to study the stability of a one-dimensional traveling wave with respect to spatial perturbations in Sobolev spaces.

We consider the system of equations

$$(2.18) \quad \frac{\partial u}{\partial t} = a\Delta u + F(u), \quad y = (y_1, y_2, y_3) \in \Omega$$

with the boundary condition

$$\left. \frac{\partial u}{\partial \nu} \right|_{\partial\Omega} = 0.$$

Here Δ is the Laplace operator with respect to $y = (y_1, y_2, y_3)$, Ω is a cylinder in \mathbb{R}^3 , $\Omega = \{(y_1, y_2, y_3) \in \mathbb{R}^3 : y_3 \in \mathbb{R}^1, (y_1, y_2) \in G\}$, where G is a bounded domain in \mathbb{R}^2 with a sufficiently smooth boundary ∂G , a is a diagonal matrix of order $m \times m$ with constant positive elements on the main diagonal, u and F are vector-valued functions, $u = (u_1, \dots, u_m)$, $F = (F_1, \dots, F_m) \in C^{(l+2)}(\mathbb{R}^m)$, where l is an integer greater than one, and ν is the normal to $\partial\Omega$.

Assume that equation (2.18) has a solution in the form of a wave $w(y_3 + ct)$, $w(x_3) = (w_1(x_3), \dots, w_m(x_3)) \in C^2(\mathbb{R}^1)$ traveling with speed c ($c > 0$), and that $w(x_3) \rightarrow w_{\pm}$ as $x_3 \rightarrow \pm\infty$. Then in the coordinates $(t, x_1, x_2, x_3) = (t, y_1, y_2, y_3 + ct)$, connected with the front of the traveling wave, equation (2.18) has the form

$$(2.19) \quad \frac{\partial u}{\partial t} = a\Delta u - c\frac{\partial u}{\partial x_3} + F(u), \quad x = (x_1, x_2, x_3) \in \Omega$$

with the boundary condition

$$(2.20) \quad \left. \frac{\partial u}{\partial \nu} \right|_{\partial\Omega} = 0$$

and $w(x_3)$ is a solution of the stationary (with respect to (2.19)) equation

$$(2.21) \quad a\frac{d^2w}{dx_3^2} - c\frac{dw}{dx_3} + F(w) = 0, \quad x_3 \in \mathbb{R}^1.$$

We assume that the vector-valued function $w(x_3) - w_+$ is summable on the semi-axis $x_3 > 0$, that $w(x_3) - w_-$ is summable on the semi-axis $x_3 < 0$, and that $dw/dx_3 \in L_2(\mathbb{R}^1)$.

We shall prove stability with shift of the vector-valued function $w(x_3)$ as a stationary solution of equation (2.19), with the boundary condition (2.20), when

Conditions 1–3 are satisfied; for the case in question, these conditions have the following form (throughout the sequel $H^r(\Omega)$ denotes the Sobolev space of vector-valued functions, given in Ω and square-summable, together with their derivatives to order r ; $\|\cdot\|_r$ is the norm in the space $H^r(\Omega)$; l is a number determining the smoothness of $F(u)$; $F'(w)$ is the Jacobian, i.e., the matrix with elements $\partial F_i/\partial w_j$, $i, j = 1, \dots, m$):

CONDITION 1. The operator

$$a\Delta u - c \frac{\partial u}{\partial x_3} + F'(w)u,$$

considered in the space $H^l(\Omega)$ with domain of definition

$$H_0^{l+2}(\Omega) = \{u \in H^{l+2}(\Omega) : \frac{\partial u}{\partial \nu} \Big|_{\partial\Omega} = 0\},$$

has a simple zero eigenvalue and no other eigenvalues with nonnegative real parts.

CONDITION 2. Operator

$$a\Delta'v - a\xi^2v + F'(w_+)v,$$

considered in the space $H^l(G)$ with domain of definition $H_0^{l+2}(G)$, has no eigenvalues with nonnegative real parts for any $\xi \in \mathbb{R}^1$. (Δ' is the Laplace operator with respect to (x_1, x_2) .)

CONDITION 3. There exists a nonnegative number σ such that the operator

$$a\Delta'v + a(i\xi + \sigma)^2v + (F'(w_-) - c\sigma)v,$$

considered in the space $H^l(G)$ with domain of definition $H_0^{l+2}(G)$, has no eigenvalues with nonnegative real parts for any $\xi \in \mathbb{R}^1$.

DEFINITION 2.3. By the space $H^{r,h}(\Omega)$ ($h \geq 0$, r is a nonnegative integer) we mean the space of vector-valued functions $u(x)$, given in Ω and such that

$$u(x)(1 + e^{-hx_3}) \in H^r(\Omega).$$

(Note that $H^{r,0}(\Omega) = H^r(\Omega)$.)

The space $H^{r,h}(\Omega)$, in which we introduce the norm

$$\|u\|_{r,h} = \|u(x)(1 + e^{-hx_3})\|_r,$$

is a Banach space.

LEMMA 2.2. *The norm $\|u\|_{r,h}$ is equivalent to the norm*

$$\left(\int_{\Omega} \sum_{|\beta| \leq r} |D^\beta u|^2 |1 + e^{-hx_3}|^2 dx \right)^{1/2},$$

where β is a multi-index, $\beta = (\beta_1, \beta_2, \beta_3)$, $|\beta| = \beta_1 + \beta_2 + \beta_3$, and

$$D^\beta = D_1^{\beta_1} D_2^{\beta_2} D_3^{\beta_3},$$

where D_j is the operator of differentiation with respect to x_j ($j = 1, 2, 3$).

The proof of the lemma is obvious.

THEOREM 2.2. *Let Conditions 1–3 above be satisfied.*

a) Suppose that the vector-valued function $w'(x_3) \in H^{l,\sigma}(\Omega)$. Then there exists a positive number ε such that for an arbitrary continuous vector-valued function $\bar{u}(x)$, given in Ω and such that $\bar{u}(x) - w(x_3) \in H^{l,\sigma}(\Omega)$, $\|\bar{u}(x) - w(x_3)\|_{l,\sigma} \leq \varepsilon$, the solution $u(x, t)$ of equation (2.19), with the initial condition $u(0, x) = \bar{u}(x)$, exists for all $t \in [0, \infty)$, is unique, $u(x, t) - w(x_3) \in H^{l,\sigma}(\Omega)$, and satisfies the estimate

$$\|u(x, t) - w(x_3 + \alpha)\|_{l,\sigma} \leq Me^{-bt},$$

where α is a number depending on $\bar{u}(x)$, and M and b are independent of t , α , and $\bar{u}(x)$.

b) Suppose that the vector-valued function $w'(x_3) \notin H^{l,\sigma}(\Omega)$. Then there exists a positive number ε such that for an arbitrary continuous vector-valued function $\bar{u}(x)$, given in Ω and such that $\bar{u}(x) - w(x_3) \in H^{l,\sigma}(\Omega)$, $\|\bar{u}(x) - w(x_3)\|_{l,\sigma} \leq \varepsilon$, the solution $u(x, t)$ of equation (2.19) with initial condition $\bar{u}(x)$ exists for all $t \in [0, \infty)$, is unique, $u(x, t) - w(x_3) \in H^{l,\sigma}(\Omega)$, and satisfies the estimate

$$\|u(x, t) - w(x_3)\|_{l,\sigma} \leq Me^{-bt},$$

where the positive numbers M and b are independent of $\bar{u}(x)$ and t .

The proof of the theorem is based on use of the results from §1. We consider case a) of the theorem. As the space H we take the space $H^{l,\sigma}(\Omega)$, and as the space E we take the space $C(\Omega)$ of functions continuous and bounded in cylinder Ω . We show that in this case all the conditions of Theorem 1.1 are satisfied, namely:

1. $H^{l,\sigma}(\Omega) \subset C(\Omega)$. (A consequence of the imbedding theorem.)
2. Equation (2.21) has a one-parameter family of solutions w_α belonging to $C(\Omega)$. (As w_α we take $w(x_3 + \alpha)$.)
3. The derivative of the stationary solution $w(x_3 + \alpha)$ with respect to α exists, taken in the norm of the space $H^{l,\sigma}(\Omega)$.

We show first that $F(w) \in H^{l,\sigma}(\Omega)$. We show the proof for $l = 2$. (The proof for $l > 2$ is handled similarly, but involves more complex calculations.) We have (throughout the sequel we omit summation signs over those indices appearing in the numerator and denominator of expressions; the summation everywhere is from 1 to m)

$$(2.22) \quad \begin{aligned} \frac{d}{dx_3} F(w) &= \frac{\partial F}{\partial w_i} \frac{\partial w_i}{\partial x_3}, \\ \frac{d^2}{dx_3^2} F(w) &= \frac{\partial^2 F}{\partial w_i \partial w_j} \frac{\partial w_i}{\partial x_3} \frac{\partial w_j}{\partial x_3} + \frac{\partial F}{\partial w_i} \frac{d^2 w_i}{dx_3^2}. \end{aligned}$$

By virtue of the condition $w'(x_3) \in H^{l,\sigma}(\Omega)$, we obtain, using (2.21) and (2.22) and the interpolational inequalities of Nirenberg (see, for example, [Nir 1]), that $F(w) \in H^{l,\sigma}(\Omega)$.

We have

$$\begin{aligned} & \frac{w(x_3 + \alpha + \Delta\alpha) - w(x_3 + \alpha)}{\Delta\alpha} - w'(x_3 + \alpha) \\ &= \int_0^1 \left(\int_0^1 w''(x_3 + \alpha + t\tau\Delta\alpha) d\tau t\Delta\alpha \right) dt \equiv A(x_3). \end{aligned}$$

Since $F(w) \in H^{l,\sigma}(\Omega)$, it then follows from the stationary equation (2.21) that

$w''(x_3) \in H^{l,\sigma}(\Omega)$. Therefore,

$$\begin{aligned} \|A\|_{l,\alpha}^2 &\leq c \int_{-\infty}^{+\infty} \sum_{k=0}^l \left| \frac{d^k}{dx_3^k} A(x_3) \right|^2 (1 + e^{-\sigma x_3})^2 dx_3 \\ &\leq c \int_{-\infty}^{+\infty} dx_3 \int_0^1 dt \int_0^1 \sum_{k=0}^l \left| \frac{d^k}{dx_3^k} w''(x_3 + \alpha + t\tau\Delta\alpha) \right|^2 (\Delta\alpha)^2 (1 + e^{-\sigma x_3})^2 d\tau \\ &\leq c_1 (\Delta\alpha)^2 \|w''\|_{l,\sigma}^2. \end{aligned}$$

Hence

$$\left\| \frac{w(x_3 + \alpha + \Delta\alpha) - w(x_3 + \alpha)}{\Delta\alpha} - w'(x_3 + \alpha) \right\|_{l,\sigma} \xrightarrow{\Delta\alpha \rightarrow 0} 0$$

which means that $w'(x_3 + \alpha)$ is also the derivative of the stationary solution $w(x_3 + \alpha)$ with respect to α , taken in the norm of the space $H^{l,\sigma}(\Omega)$.

4. The derivative $w'(x_3 + \alpha)$ satisfies a Lipschitz condition with respect to α in the norm of the space $H^{l,\sigma}(\Omega)$.

We have

$$w'(x_3 + \alpha) - w'(x_3) = \int_0^1 w''(x_3 + \alpha t) dt \alpha \equiv B(x_3),$$

$$\begin{aligned} \|w'(x_3 + \alpha) - w'(x_3)\|_{l,\sigma}^2 &\leq c \int_{-\infty}^{+\infty} \sum_{k=0}^l \left| \frac{d^k}{dx_3^k} B(x_3) \right|^2 (1 + e^{-\sigma x_3})^2 dx_3 \\ &\leq c \int_{-\infty}^{+\infty} \int_0^1 \sum_{k=0}^l \left| \frac{d^k}{dx_3^k} w''(x_3 + \alpha t) \right|^2 (1 + e^{-\sigma x_3})^2 dt dx_3 \alpha^2 \leq c_1 \alpha^2 \|w''\|_{l,\sigma}^2. \end{aligned}$$

5. The vector-valued function $F(u)$, considered as an operator in $C(\Omega)$, has a first Gateaux differential, continuous with respect to u .

This condition is satisfied by virtue of the smoothness of $F(u)$. Matrix $F'(u)$ is the Gateaux derivative of operator $F(u)$.

6. Matrix $F'(w + v)$ is a bounded operator of multiplication in $H^{l,\sigma}(\Omega)$ for $v \in H^{l,\sigma}(\Omega)$.

As we did above, we give the proof for $l = 2$. We have (omitting summation signs, $j, s = 1, 2, 3$)

(2.23)

$$\begin{aligned} F'(w + v)u &= \frac{\partial F}{\partial w_i} u_i, \\ \frac{\partial}{\partial x_j} (F'(w + v)u) &= \frac{\partial F}{\partial w_i} \frac{\partial u_i}{\partial x_j} + \frac{\partial^2 F}{\partial w_i \partial w_k} \frac{\partial (w_k + v_k)}{\partial x_j} u_j, \\ \frac{\partial^2}{\partial x_j \partial x_s} (F'(w + v)u) &= \frac{\partial F}{\partial w_i} \frac{\partial^2 u_i}{\partial x_j \partial x_s} + \frac{\partial^2 F}{\partial w_i \partial w_k} \frac{\partial (w_k + v_k)}{\partial x_s} \frac{\partial u_i}{\partial x_j} \\ &\quad + \frac{\partial^2 F}{\partial w_i \partial w_k} \frac{\partial (w_k + v_k)}{\partial x_j} \frac{\partial u_i}{\partial x_s} + \frac{\partial^2 F}{\partial w_i \partial w_k} \frac{\partial^2 (w_k + v_k)}{\partial x_j \partial x_s} u_i \\ &\quad + \frac{\partial^3 F}{\partial w_i \partial w_k \partial w_p} \frac{\partial (w_k + v_k)}{\partial x_j} \frac{\partial (w_p + v_p)}{\partial x_s} u_i. \end{aligned}$$

Using formulas (2.23), the conditions $u, v \in H^{l,\sigma}(\Omega)$, and Nirenberg's interpolation inequalities, we obtain

$$\|F'(w + v)u\|_{l,\sigma} \leq c\|u\|_{l,\sigma}.$$

7. Operator $F'(w + v)$, considered in the space $H^{l,\sigma}(\Omega)$, satisfies a Lipschitz condition with respect to $v \in H^{l,\sigma}(\Omega)$, $\|v\|_{l,\sigma} \leq 1$.

Using formulas (2.23), estimates of the type

$$\sup_x \left| \frac{\partial F(w + v)}{\partial w_i} - \frac{\partial F(w + \bar{v})}{\partial w_i} \right| \leq c \sup_x |v - \bar{v}|,$$

and Nirenberg's interpolational inequalities, we obtain

$$\|F'(w + v) - F'(w + \bar{v})\| \leq c\|v - \bar{v}\|_{l,\sigma}.$$

8. Operator

$$Lu = a\Delta u - c \frac{\partial u}{\partial x_3} + F'(w)u,$$

acting in $H^{l,\sigma}\Omega$ with domain of definition $H^{l+2,\sigma}(\Omega) \cap H_0^{l+2}(\Omega)$, is the generator of an analytic semigroup and the structure of its spectrum is as described in Assumption III c).

Let

$$\psi(x_3) = (1 + e^{-\sigma x_3})^{-1}.$$

We consider operator \bar{L} , acting in $H^l(\Omega)$ and having domain of definition $H_0^{l+2}(\Omega)$,

$$\bar{L}v = a\Delta v - (c - 2\sigma(1 - \psi)a) \frac{\partial v}{\partial x_3} + [F'(w) + a\sigma^2(1 - \psi)(1 - 2\psi) - c\sigma(1 - \psi)]v.$$

Operator \bar{L} is the generator of an analytic semigroup and it follows from the results of the preceding chapter that when Conditions 2 and 3 are satisfied the spectrum of operator \bar{L} has the following structure: outside of some closed angle, entirely contained in the open left half of the complex plane, there can be only a finite number of eigenvalues; the remaining points outside of this angle are regular points.

We have the following equalities:

$$\bar{L} = \frac{1}{\psi}L\psi, \quad L = \psi\bar{L}\frac{1}{\psi}.$$

It follows from this that operator L is the generator of an analytic semigroup and its spectrum coincides with the spectrum of operator \bar{L} . Using Condition 1, we find that the structure of the spectrum of operator L is as described in Assumption III b).

This completes the proof of part a) of the theorem. To prove part b) we need to verify that the conditions of Theorem 1.2 are satisfied, which, in fact, has already been done. This completes the proof of the theorem. \square

REMARK. As examples show, the requirement that the zero eigenvalue be simple (see Condition 1) is essential for the presence of exponential stability.

We consider, as an example of an application of Theorem 2.2, the case of a single equation (i.e., $m = 1$ in (2.18)–(2.21)). (Similar considerations for systems are taken up in §4.)

Let $w(x_3)$ be a strictly monotone function which is a solution of equation (2.21). (Conditions of smoothness and summability of the functions F and w , presented

at the beginning of this section, are assumed to be satisfied.) Without loss of generality, we can assume that $a = 1$, $w_- < w_+$, and $c > 0$, since an arbitrary problem can be reduced to this case by the substitutions $x_3 \rightarrow x_3 a^{1/2}$, $c \rightarrow ca^{1/2}$ and by the combination of substitutions $x_3 \rightarrow -x_3$, $u \rightarrow 1 - u$. It is well known that the condition for the existence of such a traveling wave implies that $F'(w_+) \leq 0$ and $F'(w_-) \leq c^2/4$ (see Chapter 1). Let

$$F'(w_+) = -\delta^2, \quad c^2/4 - F'(w_-) = \gamma^2 \quad (\gamma, \delta \geq 0).$$

LEMMA 2.3. *Let $\gamma\delta \neq 0$. Then Conditions 1-3 are satisfied for the problem in question. The number σ in Condition 3 is selected in the following way: $0 \leq \sigma \leq c/2 + \gamma$ for $F'(w_-) < 0$, and $|\sigma - c/2| < \gamma$ for $F'(w_-) \geq 0$.*

PROOF. It can be shown that the positive eigenfunction of the operator mentioned in Condition 1 corresponds to an eigenvalue with maximal real part, and this eigenvalue is simple (see §4). For the case in question, the positive function $w'(x_3)$ is an eigenfunction corresponding to a zero eigenvalue, whence satisfaction of Condition 1 follows.

Conditions 2 and 3 are satisfied in view of the requirements $\delta > 0$ and $\gamma > 0$, respectively, for the indicated choice of the number σ .

Thus, in the case of a single equation (and $\gamma\delta \neq 0$) the traveling wave $w(x_3)$ is exponentially stable with respect to small initial perturbations belonging to the space $H^{l,\sigma}(\Omega)$ (the conditions on the number σ are indicated in the lemma).

Of interest here is the question of whether this stability is stability with shift or without shift. As Theorem 2.2 implies, the answer to this question depends on whether or not $w'(x_3)$ belongs to the space $H^{l,\sigma}(\Omega)$ considered, i.e., on the behavior of $w'(x_3)$ as $x_3 \rightarrow -\infty$. For

$$F'(w_-) < 0 \quad w'(x_3) = O(e^{(c/2+\gamma)x_3}) \quad (x_3 \rightarrow -\infty),$$

i.e., $w'(x_3) \in H^{l,\sigma}(\Omega)$ ($0 \leq \sigma < c/2 + \gamma$), we have stability with shift (Theorem 2.2a)). When $F'(w) \geq 0$, two cases are possible:

$$w'(x_3) = O(e^{(c/2+\gamma)x_3}) \quad (x_3 \rightarrow -\infty)$$

and

$$w'(x_3) = O(e^{(c/2-\gamma)x_3}) \quad (x_3 \rightarrow -\infty)$$

(see Chapter 1). In the first case, $w'(x_3) \in H^{l,\sigma}(\Omega)$ ($c/2 - \gamma < \sigma < c/2 + \gamma$), and, therefore, we have stability with shift (Theorem 2.2a)). In the second case,

$$w'(x_3) \notin H^{l,\sigma}(\Omega) \quad (c/2 - \gamma \leq \sigma < c/2 + \gamma),$$

and, therefore, we have stability without shift (Theorem 2.2b)).

Let $F'(w_-) \leq 0$ and let the number σ satisfy the inequality $\sigma > c/2 + \gamma$. Then the traveling wave is unstable in the sense of Lyapunov with respect to small initial perturbations belonging to the space $H^{l,\sigma}(\Omega)$. The same assertion holds for $F'(w_-) > 0$ and number σ satisfying one of the inequalities $\sigma > c/2 + \gamma$, $0 \leq \sigma < c/2 - \gamma$. These results follow from what will be presented in §3. \square

§3. Conditions of instability

In this section we establish the absence of stability with shift for a family φ_α , $\alpha \in (-\alpha, \alpha)$, of stationary solutions of equation (1.2) for the case in which the problem, linearized on φ_0 , has points of the spectrum in the right half-plane.

The results obtained are applied in proving instability of traveling waves.

Throughout this section we assume that solutions of the problems considered exist over the whole time interval $t \in [0, \infty)$.

THEOREM 3.1. *In Banach space H we consider the equation*

$$(3.1) \quad \frac{dz}{dt} = Az + f(z),$$

where $z(t) \in H$ for $t \in [0, \infty)$, A is the generator of an analytic semigroup, $f(0) = 0$, and we have the estimate

$$\|f(z)\| \leq c\|z\|^2$$

(c is a constant, independent of z for $\|z\| \leq 1$). Let the spectrum $\sigma(A)$ of operator A contain the point λ , $\lambda \in \sigma(A)$, with positive real part: $\operatorname{Re} \lambda > 0$. Then the stationary solution $z = 0$ of equation (3.1) is unstable in the Lyapunov sense.

The theorem proved in [Dal 1], for the case of an unbounded operator A , can be carried over to the present case without change.

THEOREM 3.2. *Consider equations (1.1) and (1.2). Assume that Assumptions I, II, and III a) are satisfied. Assume that Assumption III b) is not satisfied and that the spectrum $\sigma(A)$ contains point λ with a positive real part: $\operatorname{Re} \lambda > 0$. Then the family of stationary solutions φ_α is not stable with shift relative to small initial perturbations from space H , i.e., there exist positive numbers ε and α_1 such that for an arbitrary positive number δ , we can find a $\bar{u} \in E$ such that $\bar{u} - \varphi_0 \in H$, $\|\bar{u} - \varphi_0\| < \delta$, and for solution $u(t)$ of equation (1.1) with initial condition $u(0) = \bar{u}$ we have, for some T , the estimate*

$$\|u(T) - \varphi_\alpha\| \geq \varepsilon$$

for all $\alpha \in (-\alpha_1, \alpha_1)$.

PROOF. Let $z(t) = u(t) - \varphi_0$. Then $z(t)$ satisfies the equation

$$(3.2) \quad \frac{dz}{dt} = Az + G(\varphi_0, z)$$

with initial condition $z(0) = \bar{u} - \varphi_0 \in H$ (operator $G(\varphi_0, z)$ was introduced in Lemma 1.1).

By virtue of the estimate

$$\|G(\varphi_0, z)\| \leq c\|z\|^2 \quad \text{for } \|z\| \leq 1$$

(Lemma 1.1) and Assumption III a) all the conditions of Theorem 3.1 are satisfied. Therefore there exist numbers ε and T such that for the solution $z(t)$ of equation (3.2), with initial condition $z(0) = \bar{u} - \varphi_0$, we have the estimate $\|z(T)\| \geq 2\varepsilon$. Hence, for all $\alpha \in (-\alpha_1, \alpha_1)$ and sufficiently small α_1 , we have

$$\|u(T) - \varphi_\alpha\| \geq \|u(T) - \varphi_0\| - \|\varphi_\alpha - \varphi_0\| \geq 2\varepsilon - c\alpha_1 > \varepsilon.$$

This completes the proof of the theorem. □

REMARK. If the stationary equation (1.2) has a unique solution φ_0 (uniqueness here has the same sense as that in Theorem 1.2), if Assumptions II (for $\alpha = 0$) and III a) are satisfied, and if the spectrum of operator A contains a point λ with a positive real part, we can then state that the stationary solution φ_0 is unstable in the Lyapunov sense.

Let us consider problems (2.19)–(2.20) and (2.21). Let all the restrictions on this problem, described in §2.2, be satisfied, except for Conditions 1–3. Let σ be a nonnegative number, and let at least one of the following conditions be satisfied:

1. the operator, introduced in Condition 1, has an eigenvalue with a positive real part and an eigenfunction belonging to the space $H^{l+2,\sigma}(\Omega)$;
2. the operator, introduced in Condition 2, has for some real ξ an eigenvalue with positive real part;
3. the operator, introduced in Condition 3, has for some real ξ and the number σ in question, an eigenvalue with a positive real part.

We then have the following theorem.

THEOREM 3.3. *The family of stationary solutions $w(x_3 + \alpha)$ of equation (2.20) is not stable with shift relative to small spatial perturbations from the space $H^{l,\sigma}(\Omega)$.*

The proof involves the application of Theorem 3.2. As has already been verified in the proof of Theorem 2.2, Assumptions II and III a) are satisfied for the problem in question. Fulfillment of one of the conditions given before the formulation of the theorem means (see Chapter 4 and the proof of Theorem 2.2) that the spectrum $\sigma(L)$ of the operator

$$Lu = a\Delta u - c \frac{\partial u}{\partial x_3} + F'(\varphi)u,$$

acting in the space $H^{l,\sigma}(\Omega)$ with domain of definition $H^{l+2,\sigma}(\Omega) \cap H_0^{l+2}(\Omega)$, contains a point λ with a positive real part. If $w'(x_3) \in H^{l,\sigma}(\Omega)$, then Assumption I is satisfied and, consequently, Theorem 3.2 is applicable. If $w'(x_3) \notin H^{l,\sigma}(\Omega)$, then, by virtue of the Remark to Theorem 3.2, $w(x_3)$ is unstable in the Lyapunov sense. Since in this case, $w(x_3 + \alpha) - w(x_3) \notin H^{l,\sigma}(\Omega)$, we can then also assert the instability with shift of the family of stationary solutions $w(x_3 + \alpha)$ of equation (2.21). This completes the proof of the theorem. \square

COROLLARY. *Assume that at least one of the matrices $F'(w_+)$ and $F'(w_-)$ has an eigenvalue with positive real part. Then the family of stationary solutions $w(x_3 + \alpha)$ of equation (2.21) is not stable with shift relative to small initial perturbations from the space $H^l(\Omega)$.*

REMARK. The results presented above can be carried over to the case of a many-parameter family of stationary solutions φ_α (i.e., α is a vector, $\alpha = (\alpha_1, \dots, \alpha_k)$) if the multiplicity of the zero eigenvalue of the linearized problem (see Assumption III b)) coincides with the dimensionality of the space generated by the system of functions $\partial\varphi/\partial\alpha_i$ ($i = 1, \dots, k$).

§4. Stability of waves for monotone systems

In this section we prove the main theorem concerning stability of monotone waves for monotone systems. We limit ourselves here to one-dimensional perturbations and all discussions will be carried out in weighted spaces C . Similar results

can also be obtained in Sobolev spaces, previously discussed in §2.2. Stability will be proved in the weighted norm $\|\cdot\|_\sigma$ (see (2.4)), whereby we assume the following condition is satisfied.

CONDITION S. Matrices $F'(w_-)$ and

$$(4.1) \quad a\sigma^2 - c\sigma + F'(w_+)$$

have all their eigenvalues in the left half-plane.

The question concerning the existence of a nonnegative number σ , for which this condition is satisfied, will be discussed below. It is important to note, in particular, that if the matrices $F'(w_\pm)$ have eigenvalues in the left half-plane, the discussion then concerns stability in the C -norm.

THEOREM 4.1. *Let us assume that a monotone wave solution $w(x)$ of system (2.1) with speed c exists. We assume that $F'(w(x))$ is a functionally irreducible matrix with nonnegative off-diagonal elements and that Condition S is satisfied. Then if*

$$(4.2) \quad w'(x)e^{\sigma x} \rightarrow 0 \quad \text{as } x \rightarrow \infty,$$

the wave $w(x)$ is asymptotically stable with shift in the norm $\|\cdot\|_\sigma$. If condition (4.2) is not satisfied, the wave $w(x)$ will then be asymptotically stable in the norm $\|\cdot\|_\sigma$.

Before giving the proof of this theorem, we consider the following lemma.

LEMMA 4.1. *Let us assume that a real matrix T has nonnegative off-diagonal elements and a negative principal (i.e., with the maximal real part) eigenvalue. Suppose, further, that S is a complex diagonal matrix whose elements have nonpositive real parts. Then all the eigenvalues of the matrix $T + S$ have negative real parts.*

PROOF. Let the vector $p > 0$ be such that $TP < 0$, and let P be a diagonal matrix with elements of the vector $p = (p_1, \dots, p_n)$ on the diagonal. Then the sum of the elements of the rows of the matrix $P^{-1}TP$ is negative. The matrices $T + S$ and

$$P^{-1}(T + S)P = P^{-1}TP + S$$

have identical eigenvalues. Let T_{ij} and S_{ij} be the elements of matrices T and S , respectively. By a theorem of Gershgorin, the eigenvalues of the matrix $P^{-1}TP + S$ lie in disks with centers at the points $T_{jj} + S_{jj}$ and of radius r ,

$$r = \sum_{k \neq j} p_j^{-1} T_{jk} p_k.$$

Since

$$\sum_{k=1}^n p_j^{-1} T_{jk} p_k + \operatorname{Re} S_{jj} < 0,$$

then all the Gershgorin disks lie in the left half-plane. This completes the proof of the lemma. \square

PROOF OF THE THEOREM. We now need to verify that the conditions for Theorem 2.1 to be valid are satisfied. Conditions 2 and 3 of §2 follow from Condition S and the lemma.

Since $w(x)$ is a monotone function, it follows that $w'(x)$ is of definite sign. Suppose, for example, that $w'(x) < 0$. It is easy to see, from the existence of the limit w_- , that

$$\lim_{x \rightarrow -\infty} w'(x) = 0.$$

Let the condition (4.2) be satisfied. Then, obviously,

$$(4.3) \quad \lim_{|x| \rightarrow \infty} w'(x)(1 + e^{\sigma x}) = 0.$$

This means that $w'(x) \in C_\sigma$. In order to show that the remaining requirements of Condition 1 are satisfied, we apply Theorem 5.1 of Chapter 4 to the operator \tilde{L} , given by equation (2.8), in the space C_σ . This can be done since the matrix $F'(w(x))$ is functionally irreducible and the limiting values of the matrix of coefficients of v (as $x \rightarrow \pm\infty$) have negative principal eigenvalues, by virtue of Condition S.

Further, since $Lw' = 0$, then

$$v = -Tw' = -(1 + e^{\sigma x})w'$$

is a positive solution of the equation $\tilde{L}v = 0$. By (4.3) we have

$$v(x) \rightarrow 0 \quad \text{as } |x| \rightarrow \infty.$$

Thus, on the basis of the aforementioned Theorem 5.1 of Chapter 4, operator \tilde{L} has a simple zero eigenvalue and no other eigenvalue with a nonnegative real part in the space C_0 . It follows from (2.7) that operator L possesses this property in the space C_σ , i.e., the requirements of Condition 1 are satisfied. From Theorem 2.1 we conclude that wave $w(x)$ is asymptotically stable with shift in the norm $\|\cdot\|_\sigma$.

We assume now that condition (4.2) is not satisfied. Then, obviously, $w'(x)$ does not belong to space C_σ . In order to prove that the requirements of Condition 1' of §2 are satisfied, it remains only to verify that all the eigenvalues of operator L in space C_σ have negative real parts, or the same for operator \tilde{L} in space C_0 . But this follows directly from Theorem 5.1 of Chapter 4. We can now use Theorem 2.1, which implies the asymptotic stability of the wave $w(x)$. The theorem is proved. \square

Consider now Condition S; more precisely, the possibility of selecting a number $\sigma \geq 0$ such that the matrix

$$T(\sigma) = a\sigma^2 - c\sigma + B_+$$

has all its eigenvalues in the left half-plane. Here, as above, we have set $B_\pm = F'(w_\pm)$. The fact that matrix B_- has a negative principal eigenvalue will be assumed.

Let μ_+ be the principal eigenvalue of matrix B_+ . It is clear that if $\mu_+ < 0$, we can then assume that $\sigma = 0$. If $\mu_+ = 0$, then when $c > 0$ (and only this case will interest us), we can take $\sigma > 0$ sufficiently small.

Consider the case $\mu_+ > 0$. With this in mind, we introduce the matrix

$$(4.4) \quad K(\tau) = a\tau + B_+\tau^{-1} \quad \text{for } \tau > 0.$$

This matrix has nonnegative off-diagonal elements. We denote its principal eigenvalue, i.e., the eigenvalue with maximum real part, by $\mu(\tau)$. Let a_* and a^* be the

smallest and the largest, respectively, of the diagonal elements of matrix a . We then have inequalities

$$(4.5) \quad a_*\tau + \mu_+\tau^{-1} \leq \mu(\tau) \leq a^*\tau + \mu_+\tau^{-1}.$$

Let us prove, for example, the inequality on the right. We have

$$K(\tau) \leq a^*\tau + B_+\tau^{-1}$$

(inequality applies elementwise). This inequality, as is well known, applies also for the maximum eigenvalues; the inequality on the right in (4.5) follows from this.

Let

$$\mu_* = \inf \mu(\tau) \quad \text{for } \tau > 0.$$

Obviously, then, it follows from (4.5) that

$$(4.6) \quad 2(a_*\mu_+)^{1/2} \leq \mu_* \leq 2(a^*\mu_+)^{1/2}.$$

The number μ_* , i.e., the lower bound of the maximum eigenvalues of matrix (4.4), gives an estimate from below of the wavespeeds. More precisely, we have the following lemma.

LEMMA 4.2. *If $w(x)$ is a monotonically decreasing wave solution of the monotone system (2.1) and $B_+ = F'(w_+)$ has a positive maximum eigenvalue and (for $n \geq 2$) positive off-diagonal elements, we then have the following inequality for the speed c of wave w :*

$$(4.7) \quad c \geq \mu_*.$$

PROOF. Based on Lemma 2.4 of Chapter 3, there exists a number $\tau > 0$ and a vector $q > 0$, such that $T(\tau)q = 0$. Obviously, $\tau \neq 0$, since $\mu_+ > 0$. Hence $K(\tau)q = cq$. Since $q > 0$, it follows that c is a maximum eigenvalue, i.e., $c = \mu(\tau)$; inequality (4.7) follows from this. This completes the proof of the lemma. \square

We note that the wavespeed can take on the value μ_* . For example, in the case of the scalar equation with $a = 1$, we have $\mu_* = 2(F'(w_+))^{1/2}$. In particular, the wavespeed takes on such a value in the case of the Kolmogorov-Petrovsky-Piskunov equation [Kolm 1]. However, as is well known, for positive sources the minimum wavespeed can be even larger than μ_* . If a is a scalar matrix, it then obviously follows from (4.6) that $\mu_* = 2a_*^{1/2}$ ($a_* = a^*$).

THEOREM 4.2. *If B_+ has a positive eigenvalue with maximal real part, then for the existence of a number $\sigma > 0$ such that matrix (4.1) has all negative eigenvalues, it is necessary and sufficient that the following condition be satisfied:*

$$(4.8) \quad c > \mu_*.$$

PROOF. It is obvious that the following relationship holds between the eigenvalues of matrices $T(\tau)$ and $K(\tau)$ with maximal real parts:

$$(4.9) \quad \lambda(\tau) = (\mu(\tau) - c)\tau,$$

where λ and μ are eigenvalues with maximal real parts of matrices T and K , respectively. Let us show the necessity of the condition (4.8). Assume that a number σ exists, such that $\lambda(\sigma) < 0$. Then from (4.9) we have $\mu(\sigma) < c$, and, all the more, $\mu_* < c$. Let us show the sufficiency of the condition next. Assume

that (4.8) holds. Then for some σ we have $c > \mu(\sigma)$, and from (4.9) we obtain $\lambda(\sigma) < 0$. This completes the proof of the theorem. \square

§5. On the solutions of nonstationary problems

This section is of an auxiliary nature. The results presented here are used in various problems in the study of waves and the approach to a wave.

5.1. Problem of Cauchy: existence of solutions and estimates of derivatives. Consider the Cauchy problem for the system of quasilinear equations

$$(5.1) \quad \frac{\partial v}{\partial t} = a \frac{\partial^2 v}{\partial x^2} + F(x, t, v),$$

$$(5.2) \quad v(x, 0) = f(x),$$

where $t \geq 0$, $x \in \mathbb{R}$, $v = (v_1, \dots, v_n)$, $F = (F_1, \dots, F_n)$ are continuous bounded vector-valued functions satisfying a Lipschitz condition in x and v , $f = (f_1, \dots, f_n)$ is a piecewise-continuous vector-valued function with a finite number of points of discontinuity; a is a square diagonal matrix of order n with positive diagonal elements a_i , $i = 1, \dots, n$. Throughout the sequel we consider classical solutions of problem (5.1), (5.2), i.e., we assume a solution has continuous derivatives with respect to x , to the second order inclusive, and continuous derivatives with respect to t for $t > 0$; and we also assume that the solution is continuous up to the boundary at those points where the initial functions are continuous. Solutions of boundary value problems are to be understood in an analogous sense.

Nonlocal existence of solutions of the Cauchy problem (5.1), (5.2) was established in [Kolm 1] for the scalar equation and carried over in [Mur 1] to systems of equations. For what follows, the following theorem is sufficient (although more general results are known).

THEOREM 5.1. *There exists one and only one function $v(x, t)$, bounded for bounded values of t , which for $t > 0$ satisfies equation (5.1) and for $t = 0$ takes on the values $f(x)$ at all points of continuity of this vector-valued function.*

PROOF. Let $\Phi(x, t)$ be the fundamental solution of the system of equations

$$\frac{\partial v}{\partial t} = a \frac{\partial^2 v}{\partial x^2}.$$

$\Phi(x, t)$ is a diagonal square matrix of order n with elements $\Phi_i(x, t)$, $i = 1, \dots, n$, on the diagonal,

$$\Phi_i(x, t) = \frac{1}{2\sqrt{\pi a_i t}} \exp\left(-\frac{x^2}{4a_i t}\right).$$

We set

$$(5.3) \quad v^0(x, t) = \int_{-\infty}^{+\infty} \Phi(x - y, t) f(y) dy,$$

$$(5.4) \quad v^{k+1}(x, t) = v^0(x, t) + \int_0^t \int_{-\infty}^{+\infty} \Phi(x - y, t - \tau) F(v^k(y, x), y, t) dy dt.$$

At points of continuity of the vector-valued function $f(x)$ we have $v_0(x, t) \rightarrow f(x)$ as $t \rightarrow 0$. Letting

$$M_0 = \sup_{v,x,t} \|F(v, x, t)\|, \quad M_{k+1}(t) = \sup_{x,\tau \leq t} \|v^{k+1}(x, \tau) - v^k(x, \tau)\|,$$

$k = 0, 1, 2, \dots$, where $\| \cdot \|$ is the Euclidean norm of the vector, we obtain

$$\|v^1 - v^0\| \leq \sqrt{n}M_0t, \quad \|v^{k+1} - v^k\| \leq c\sqrt{n} \int_0^t M_k(\tau) d\tau, \quad k = 1, 2, \dots$$

Here c is the Lipschitz constant for the vector-valued function F . From this we have

$$M_{k+1}(t) \leq \frac{M_0 (c\sqrt{n}t)^{k+1}}{c (k+1)!},$$

and for arbitrary fixed t the sequence $v_k(x, t)$ converges to a function $v(x, t)$. Passing to the limit in (5.4), we obtain

$$(5.5) \quad v(x, t) = v^0(x, t) + \int_0^t \int_{-\infty}^{+\infty} \Phi(x - y, t - \tau) F(v(y, \tau), y, \tau) dy d\tau,$$

from which it follows that $v(x, t)$ is a solution of problem (5.1), (5.2).

Uniqueness of the solution may be proved as follows. If along with solution $v(x, t)$, we also have the solution $\tilde{v}(x, t)$, then from (5.5)

$$v - \tilde{v} = \int_0^t \int_{-\infty}^{+\infty} \Phi[F(v, y, \tau) - F(\tilde{v}, y, \tau)] dy d\tau.$$

Letting

$$N(t) = \sup_{x,\tau \leq t} \|v(x, \tau) - \tilde{v}(x, \tau)\|,$$

we obtain

$$N(t) \leq c\sqrt{n} \int_0^t N(\tau) d\tau,$$

from which it follows that $N(t) \equiv 0$. This completes the proof of the theorem. \square

We proceed now to an estimate of the derivatives. Assume that we have an a priori estimate of solutions of problem (5.1), (5.2):

$$(5.6) \quad \sup_{x \in R, t > 0} |v(x, t)| \leq K.$$

From the integral representation (5.5) we obtain an estimate of the derivative:

$$(5.7) \quad |v'(x, t)| \leq c(\|f\|t^{-1/2} + \sup_{|v| < K, x, t} |F(v, x, t)|t^{1/2}),$$

where c is a constant. Taking (5.6) into account and the semigroup property of

equation (5.1), we conclude from (5.7) that for all $t \geq t_0 > 0$ the derivatives $v'(x, t)$ are bounded:

$$(5.8) \quad |v'(x, t)| \leq K_1.$$

Assume now that $F(x, t, v)$ has continuous derivatives with respect to x and v . It then follows from (5.5) that

$$v'(x, t) = \int_{-\infty}^{+\infty} \Phi'(x - y, t) f(y) dy + \int_0^t \int_{-\infty}^{+\infty} \Phi(x - y, t - \tau) \frac{\partial}{\partial y} F(v(y, \tau), y, \tau) dy d\tau.$$

Differentiating this equation with respect to x and using (5.8), we obtain

$$(5.9) \quad |v''(x, t)| \leq K_2$$

for all $x \in \mathbb{R}$ and $t > t_0$.

Directly from system (5.1) we now have the estimate

$$(5.10) \quad |\dot{v}(x, t)| \leq N,$$

for $x \in \mathbb{R}$ and $t > t_0$, where N is a constant.

To obtain further estimates we differentiate system (5.1) with respect to x :

$$(5.11) \quad \frac{\partial v'}{\partial t} = a \frac{\partial^2 v'}{\partial x^2} + F'_v(x, t, v) v' + F'_x(x, t, v).$$

We consider this system in the half-space $t > t_0$, where we have already obtained an estimate of its solution v' . Since system (5.11) is of the same form as the initial system (5.1), we can apply to it the results obtained. Assuming that $F(x, t, v)$ has continuous second derivatives with respect to v and x , we obtain, similarly to (5.9) and (5.10),

$$(5.12) \quad |v'''(x, t)| \leq K_3, \quad |\dot{v}'(x, t)| \leq N_1,$$

for $x \in \mathbb{R}$, $t > 2t_0$, where K_3 and N_1 are constants.

Constants K_1, K_2, K_3, N, N_1 , appearing in the above estimates, depend on K and t_0 , and are independent of x, t , and f ($|f| \leq K$).

5.2. Behavior of solutions as $x \rightarrow \pm\infty$. The following theorem uses constructions employed in the proof of Theorem 5.1. The conditions formulated are assumed to be satisfied.

THEOREM 5.2. *Suppose that for arbitrary v^* and t the following limits exist:*

$$\lim_{v \rightarrow v^*, x \rightarrow \pm\infty} F(v, x, t) = F_{\pm}(v^*, t),$$

as well as the limits

$$\lim_{x \rightarrow \pm\infty} f(x) = f_{\pm}.$$

Then the solution $v(x, t)$ of equation (5.1) has limits $v_{\pm}(t)$ as $x \rightarrow \pm\infty$, and the vector-valued function $v_{\pm}(t)$ satisfies the system of equations

$$(5.13) \quad \frac{dv_{\pm}}{dt} = F_{\pm}(v, t), \quad v_{\pm}(0) = f_{\pm}.$$

PROOF. Making the change of variables $x - y = z$ under the integral sign in (5.3) and passing to the limit as $x \rightarrow \pm\infty$, we obtain existence of the limits

$$v_{\pm}^0(t) = \lim_{x \rightarrow \pm\infty} v^0(x, t) \quad (= f_{\pm}).$$

Similarly, from (5.4)

$$(5.14) \quad v_{\pm}^{k+1}(t) = v_{\pm}^0(t) + \int_0^t F(v_{\pm}^k(\tau), \tau) d\tau.$$

The sequence of functions $v_{\pm}^k(\tau)$ converges uniformly for $\tau \leq t$ to some function $v_{\pm}(\tau)$, by virtue of the uniform convergence of the functions $v^k(x, \tau)$. Passing to the limit in (5.14), we obtain

$$v_{\pm}(t) = f_{\pm} + \int_0^t F(v_{\pm}(\tau), \tau) d\tau,$$

from which validity of (5.13) follows. This completes the proof of the theorem. \square

We note that this theorem implies a necessary condition for approach to a wave (see Chapter 1).

5.3. Positiveness theorems for linear operators. Consider the linear operator

$$Lu = a(x, t) \frac{\partial^2 u}{\partial x^2} + b(x, t) \frac{\partial u}{\partial x} + c(x, t)u - \frac{\partial u}{\partial t}.$$

Here $u = (u_1, \dots, u_n)$ is a vector-valued function; a, b, c are continuous square matrices; a and b are diagonal matrices; a has positive diagonal elements; c has nonnegative off-diagonal elements.

Let

$$\Omega_0 = R \times (0, T], \quad \Omega = R \times [0, T].$$

We assume that $u(x, t)$, continuous in Ω , is twice continuously differentiable in Ω_0 .

Following [Fri 1], we prove an assertion concerning nonnegativeness of solutions of the Cauchy problem.

LEMMA 5.1. *Let the sum of the elements in each row of the matrix $c(x, t)$ be bounded from above with respect to x and t . If $Lu \leq 0$ in Ω_0 , $u(x, 0) \geq 0$ for $x \in R$, and, uniformly with respect to $t \in [0, T]$,*

$$\lim_{|x| \rightarrow \infty} u(x, t) \geq 0,$$

then $u(x, t) \geq 0$ in Ω .

PROOF. We set

$$\gamma > \sup_{i,x,t} \sum_{j=1}^n c_{ij},$$

where c_{ij} are the elements of matrix c , and we introduce a new function $v = ue^{-\gamma t}$. Then if $Lu = f$, we have

$$\bar{L}v \equiv av'' + bv' + \bar{c}v - \frac{\partial v}{\partial t} = \bar{f},$$

where $\bar{c} = c - \gamma E$, E is the unit matrix, $\bar{f} = fe^{-\gamma t} \leq 0$. Let $p = (1, \dots, 1)$. For the function $v(x, t) + \varepsilon p$ we have

$$\bar{L}(v + \varepsilon p) = \bar{f} + \varepsilon(c - \gamma E)p < 0,$$

since $(c - \gamma E)p < 0$. Further,

$$v(x, t) + \varepsilon p > 0 \quad \text{for } t = 0 \text{ and for } |x| = R, \quad 0 \leq t \leq T,$$

if R is sufficiently large. Therefore $v(x, t) + \varepsilon p > 0$ for $|x| \leq R$, $0 \leq t \leq T$ (see Lemma 5.2). As $\varepsilon \rightarrow 0$, we obtain $v(x, t) \geq 0$ in Ω and, consequently, $u(x, t) \geq 0$ in Ω . This completes the proof of the lemma. \square

LEMMA 5.2. *If $Lu \leq 0$ in $Q = [x_1, x_2] \times [0, T]$, $u(x, 0) \geq 0$ for $x \in [x_1, x_2]$, and $u(x_k, t) \geq 0$ ($k = 1, 2$) for $t \in [0, T]$, then $u(x, t) \geq 0$ in Q . Here x_1 and x_2 are some numbers.*

PROOF. As in the proof of the preceding lemma, we have

$$(5.15) \quad \begin{aligned} &L(v + \varepsilon p) < 0, \\ &v + \varepsilon p > 0 \quad \text{for } t = 0 \text{ and for } x = x_k, \quad 0 \leq t \leq T. \end{aligned}$$

We show that $v + \varepsilon p > 0$ in Q . If this is not the case, we can then find $(x_0, t_0) \in Q$, such that

$$v(x, t) + \varepsilon p \geq 0 \quad \text{for } 0 \leq t \leq t_0, \quad x_1 \leq x \leq x_2$$

and for some component of the vector, for example, the first

$$(v(x_0, t_0) + \varepsilon p)_1 = 0.$$

Therefore, $v_1''(x_0, t_0) \geq 0$, $v_1'(x_0, t_0) = 0$, $\left. \frac{\partial v_1}{\partial t} \right|_{x_0, t_0} \leq 0$, $(\bar{c}(v(x_0, t_0) + \varepsilon p))_1 \geq 0$, since matrix \bar{c}_{ij} has nonnegative off-diagonal elements. Therefore, in the first inequality of system (5.15) we obtain a contradiction. Letting ε tend towards zero, we obtain $v \geq 0$ and $u \geq 0$ in Q . The lemma is thereby proved. \square

REMARKS. 1. The lemma can obviously be generalized to more complex domains.

2. From the lemma in question and the theorem concerning strict positive-ness for the scalar equation (see Chapter 1) there follows an analogous assertion concerning strict positiveness for the systems of equations considered.

THEOREM 5.3. *Let us assume that matrices a, b , and c satisfy the following conditions in Ω_0 :*

$$|a_i(x, t)| \leq M, \quad |b_i(x, t)| \leq M(|x| + 1), \quad c_{ij}(x, t) \leq M(x^2 + 1).$$

We assume that $Lu \leq 0$ in Ω_0 and that

$$u_i(x, t) \geq -B \exp(\beta x^2) \quad \text{in } \Omega, \quad i = 1, \dots, n,$$

for certain constants B and β . If $u(x, 0) \geq 0$ for all x , then $u(x, t) \geq 0$ in Ω .

PROOF. Following a procedure similar to that in [Fri 1] for the scalar equation, we introduce the function

$$H(x, t) = \exp\left(\frac{kx^2}{1 - \mu t} + \nu t\right), \quad 0 \leq t \leq 1/2\mu,$$

where μ and ν are positive numbers.

Consider the function v , defined by the equations $u_i = H v_i$, $i = 1, \dots, n$. Obviously,

$$v_i \geq -B \exp\left(\left(\beta - \frac{k}{1 - \mu t}\right)x^2 - \nu t\right).$$

If $k > \beta$, then

$$\lim_{|x| \rightarrow \infty} v(x, t) \geq 0,$$

uniformly with respect to t , $0 \leq t \leq 1/2\mu$.

Substituting the expression $u = H v$ into the equation $Lu = f$, we obtain

$$\bar{L}v \equiv av'' + \bar{b}v' + \bar{c}v - \dot{v} = \bar{f},$$

where

$$\begin{aligned} \bar{b} &= b + (H'/H)2a, & \bar{f} &= f/H \leq 0, \\ \bar{c} &= (H''/H)a + (H'/H)b + c - (\dot{H}/H)E. \end{aligned}$$

In order to be able to apply Lemma 5.1 to operator \bar{L} , it is sufficient to verify that the sum of the elements of matrix \bar{c} over its rows is bounded from above. We have

$$\begin{aligned} \sum_{j=1}^n \bar{c}_{ij} &\leq M \left[\frac{(2kx)^2}{(1 - \mu t)^2} + \frac{2k}{1 - \mu t} \right] + M(|x| + 1) \frac{2kx}{1 - \mu t} \\ &\quad + Mn(x^2 + 1) - \nu - \mu \frac{kx^2}{(1 - \mu t)^2}. \end{aligned}$$

Thus, for arbitrarily given M , k , and n , we can select μ and ν so that the expression on the right-hand side of the inequality is nonpositive for $0 \leq t \leq 1/2\mu$. By virtue of Lemma 5.1 $v(x, t) \geq 0$ and, consequently, $u(x, t) \geq 0$ for $0 \leq t \leq 1/2\mu$. Similarly, we may prove this for $1/2\mu \leq t \leq 2/2\mu$, etc. This completes the proof of the theorem. \square

REMARK. This theorem remains valid for the problem on the semi-axis $x \geq 0$ with boundary condition $u(0, t) \geq 0$ and for piecewise-continuous initial conditions.

As was the case above, we say that a continuous bounded matrix $F(x)$ is functionally irreducible if the numerical matrix, formed by the C -norms of the elements of matrix F , is irreducible.

THEOREM 5.4 (On strict positiveness). *If $Lu \leq 0$ in Ω_0 , $u(x, t) \geq 0$ in Ω , $u(x, 0) \not\equiv 0$, and $c(x, 0)$ is functionally irreducible, then $u(x, t) > 0$ in Ω_0 .*

PROOF. Since matrix $c(x, t)$ has nonnegative off-diagonal elements, then

$$a_i u_i'' + b_i u_i' + c_{ii} u_i - \frac{\partial u_i}{\partial t} \leq 0.$$

It follows from the theorem on positiveness of solutions for scalar parabolic equations (see Chapter 1) that if $u_i(x_0, t_0) = 0$ ($t_0 > 0$), then $u_i(x, t) \equiv 0$ for $0 \leq t \leq t_0$. It is therefore sufficient to show, for arbitrarily small positive ε , that $u_i(x, \varepsilon) > 0$, $i = 1, \dots, n$, $-\infty < x < +\infty$.

We assume that these inequalities are not satisfied for all components of the vector $u(x, \varepsilon)$. Without loss of generality, we can assume they are not satisfied for the functions $u_1(x, \varepsilon), \dots, u_k(x, \varepsilon)$. In the contrary case they can be renumbered (moreover, properties of matrices a, b , and c are preserved). Consequently, for some $\varepsilon > 0$

$$\begin{aligned} u_i(x, t) &\equiv 0, & i = 1, \dots, k, & & 0 \leq t \leq \varepsilon, & & -\infty < x < +\infty, \\ u_i(x, t) &> 0, & i = k + 1, \dots, n, & & 0 < t \leq \varepsilon, & & -\infty < x < +\infty. \end{aligned}$$

We have

$$(Lu)_i = a_i u_i'' + b_i u_i' + \sum_{j=1}^k c_{ij} u_j + \sum_{j=k+1}^n c_{ij} u_j - \frac{\partial u_j}{\partial t} \leq 0.$$

It is obvious that for $i = 1, \dots, k$, $t = \varepsilon$, we have $u_i' \equiv 0$, $u_i'' \equiv 0$, $\partial u_i / \partial t \equiv 0$, $\sum_{j=1}^k c_{ij} u_j \equiv 0$. Since $u_j > 0$, $j = k + 1, \dots, n$, for all x and $c_{ij} \geq 0$, it follows that $c_{ij}(x, \varepsilon) \equiv 0$, $i = 1, \dots, k$, $j = k + 1, \dots, n$. This means that matrix $c(x, \varepsilon)$ is reducible. Since matrix c is continuous in Ω , and ε can be taken arbitrarily small, this then contradicts the irreducibility of matrix $c(x, 0)$. Thus the theorem is proved. □

REMARK. This theorem may easily be generalized to the case of piecewise-continuous initial conditions.

5.4. Comparison theorems for monotone systems. Consider the system of equations

$$(5.16) \quad \frac{\partial u}{\partial t} = a(x, t) \frac{\partial^2 u}{\partial x^2} + b(x, t) \frac{\partial u}{\partial x} + F(x, t, u),$$

where matrices a and b satisfy the same conditions as in the preceding section; $F = (F_1, \dots, F_n)$,

$$(5.17) \quad \frac{\partial F_i}{\partial u_j} \geq 0, \quad i \neq j, \quad i, j = 1, \dots, n,$$

for all u, x , and $t \geq 0$.

If we denote by $u^1(x, t)$ and $u^2(x, t)$ the solutions of the Cauchy problem for system (5.16) with initial conditions $u^1(x, 0) = f^1(x)$ and $u^2(x, 0) = f^2(x)$,

respectively, then the function $z(x, t) = u^2(x, t) - u^1(x, t)$ is a solution of the system of equations

$$\frac{\partial z}{\partial t} = a(x, t) \frac{\partial^2 z}{\partial x^2} + b(x, t) \frac{\partial z}{\partial x} + c(x, t)z,$$

where

$$c(x, t) = \int_0^1 F'_u(x, t, \tau u^2(x, t) + (1 - \tau)u^1(x, t)) d\tau,$$

with initial condition

$$z(x, 0) = f^2(x) - f^1(x).$$

We assume that the derivatives (5.17) are continuous. Then matrix $c(x, t)$ is continuous and has nonnegative off-diagonal elements. The following theorem follows directly from Theorem 5.3.

THEOREM 5.5. *Let matrices a , b , and F'_u be continuous and, for simplicity, bounded for $(x, t) \in \Omega$ in an arbitrary bounded domain with respect to u . Then if condition (5.17) is satisfied and $f^i(x)$, $i = 1, 2$, are continuous vector-valued functions, $f^2(x) \geq f^1(x)$ for $-\infty < x < +\infty$, then for the corresponding bounded solutions $u^1(x, t)$ and $u^2(x, t)$ of the Cauchy problem for the system of equations (5.16) we have the inequality*

$$u^2(x, t) \geq u^1(x, t) \quad \text{in } \Omega.$$

COROLLARY 1. *If $F(x, t, u_0) \equiv 0$ and $f(x) \geq u_0$ ($f(x) \leq u_0$), then $u(x, t) \geq u_0$ ($u(x, t) \leq u_0$).*

Next, we consider the system of equations

$$(5.18) \quad \frac{\partial u}{\partial t} = a(x) \frac{\partial^2 u}{\partial x^2} + b(x) \frac{\partial u}{\partial x} + F(x, u),$$

where a and b are diagonal matrices, a has positive diagonal elements, and F satisfies conditions (5.17).

COROLLARY 2. *If $f(x)$ is a twice continuously differentiable function and*

$$(5.19) \quad a(x)f'' + b(x)f' + F(x, f) \geq 0 \quad (\leq 0),$$

then solution $u(x, t)$ of the Cauchy problem for the system of equations (5.18) with initial condition $u(x, 0) = f(x)$ does not decrease (does not increase) with respect to t for each fixed value of x .

PROOF. Function $v(x, t) = u'_t(x, t)$ is a solution of the Cauchy problem

$$\begin{aligned} \frac{\partial v}{\partial t} &= a(x) \frac{\partial^2 v}{\partial x^2} + b(x) \frac{\partial v}{\partial x} + F'_u(x, u)v, \\ v(x, 0) &= a(x)f'' + b(x)f' + F(x, f). \end{aligned}$$

We see from this that $v(x, t) \geq 0$ (≤ 0). This completes the proof of the corollary. □

REMARKS. 1. When inequality (5.19) is satisfied, we call $f(x)$ a lower (upper) function.

2. Positiveness theorems and comparison theorems for monotone systems can be generalized for piecewise-continuous initial conditions; we shall not pause to consider this here. We merely remark that if the lower (upper) functions are taken

to be continuous piecewise-smooth, then at points of discontinuity of the derivative we need to require that $f'(x+0) - f'(x-0)$ be nonnegative (nonpositive) and that inequality (5.19) be satisfied at the points of continuity of the derivative. Corollary 2 remains valid even in this case. This is an easy consequence of the arguments that the *supremum* of two lower functions (*infimum* of upper functions) is a lower (upper) function.

§6. Approach to a monotone wave

We showed in §4, assuming Condition S to be satisfied, that we have stability of a monotone wave for monotone systems in the $\|\cdot\|_\sigma$ -norm. Here we show, in the case (4.2), i.e., in the case of asymptotic stability with shift, that we have approach to a wave from arbitrary monotone initial conditions with the same behavior at infinity as the wave. Let us clarify this more precisely. We note, by virtue of (4.2) and

$$(6.1) \quad \lim_{x \rightarrow \pm\infty} w(x) = w_\pm,$$

that we have, obviously,

$$(6.2) \quad \lim_{x \rightarrow \infty} |w(x) - w_+|e^{\sigma x} = 0.$$

For the initial condition $f(x)$ we also require existence of the limits

$$(6.3) \quad \lim_{x \rightarrow -\infty} f(x) = w_-, \quad \lim_{x \rightarrow \infty} |f(x) - w_+|e^{\sigma x} = 0.$$

We prove the following theorem.

THEOREM 6.1. *We assume the conditions of Theorem 4.1 are satisfied and that (4.2) holds. Further, let $f(x)$ be a monotone function satisfying conditions (6.3). Then the solution $u(x, t)$ of the Cauchy problem for system (2.1), with the initial condition*

$$u(x, 0) = f(x),$$

converges to a wave in the $\|\cdot\|_\sigma$ -norm:

$$\|u(x, t) - w(x + x_0)\|_\sigma \rightarrow 0 \quad \text{as } t \rightarrow \infty,$$

where x_0 is some number.

We preface the proof of this theorem with the following simple lemma.

LEMMA 6.1. *Let $g(x)$ and $h(x)$ be monotonically decreasing continuous functions, given on the interval $[a, b]$, where $g(a) > h(b)$. Then there exists a continuous monotonically decreasing function $\varphi(x)$, such that $\varphi(a) = g(a)$, $\varphi(b) = h(b)$,*

$$|\varphi(x) - g(x)| \leq |h(x) - g(x)|, \quad |\varphi(x) - h(x)| \leq |h(x) - g(x)|.$$

PROOF. If the graphs of functions $h(x)$ and $g(x)$ intersect, we then denote their left-hand point of intersection by x_0 and we set $\varphi(x) = g(x)$ for $x \leq x_0$, and $\varphi(x) = h(x)$ for $x \geq x_0$.

If $g(x) > h(x)$ for $a \leq x \leq b$, we introduce an auxiliary function $\psi(x)$, continuous and monotonically decreasing such that $\psi(a) = g(a)$, $\psi(b) < h(b)$, and $\psi(x) \leq g(x)$. Let x_0 be the left-hand point of intersection of $\psi(x)$ and $h(x)$. Then we set $\varphi(x) = \psi(x)$ for $x \leq x_0$, and $\varphi(x) = h(x)$ for $x \geq x_0$.

Finally, if $h(x) > g(x)$, we then introduce a continuous monotonically decreasing function $\psi(x)$: $\psi(a) = g(a)$, $\psi(x) \geq g(x)$, $\psi(b) > h(b)$. Let x_0 be the left-hand point of intersection of $\psi(x)$ and $h(x)$. Then $\varphi(x)$ is considered as was done above. This completes the proof of the lemma. \square

PROOF OF THE THEOREM. For definiteness, we assume that wave $w(x)$ is monotonically decreasing, i.e., $w_- > w_+$. Then, obviously, $f(x)$ is a monotonically nonincreasing function. With no loss of generality we can assume that $f(x)$ is a continuous monotonically decreasing function since, in place of $f(x)$ as the initial condition, we can take $u(x, t_0)$ for some $t_0 > 0$. Moreover, it is not difficult to show that the equations (6.3) will be satisfied for the new initial condition.

We introduce function $f_*(x)$, so that the following conditions are satisfied:

- 1) $\|w - f_*\|_\sigma < \varepsilon$, where ε is the number indicated in the definition for stability of a wave;
- 2) $f(x) - f_*(x)$ has a compact support;
- 3) $f_*(x)$ is a monotonically decreasing function.

We show that such a function exists. Indeed, from (6.1), (6.2), and (6.3) it follows that

$$\lim_{|x| \rightarrow \infty} |f(x) - w(x)|(1 + e^{\sigma x}) = 0.$$

Therefore, there exists a number $\xi > 0$ such that

$$(6.4) \quad |f(x) - w(x)|(1 + e^{\sigma x}) < \varepsilon$$

for $|x| > \xi$. We set

$$f_*(x) = w(x) \quad \text{for } |x| \leq \xi.$$

We indicate how to construct function $f_*(x)$ for $x > \xi$. For $x < -\xi$ the procedure is similar. We select a number $\eta > \varepsilon$, so that $w(\xi) > f(\eta)$. On the interval $[\xi, \eta]$ we apply the lemma proved above to the elements of the vector-valued functions $w(x)$ and $f(x)$. We obtain a continuous decreasing vector-valued function $f_*(x)$: $f_*(\xi) = w(\xi)$, $f_*(\eta) = f(\eta)$,

$$|f_*(x) - w(x)| \leq |f(x) - w(x)|, \quad x \in [\xi, \eta].$$

From (6.4) we obtain

$$|f_*(x) - w(x)|(1 + e^{\sigma x}) < \varepsilon.$$

It remains to set $f_*(x) = f(x)$ for $x > \eta$.

Thus we have constructed function $f_*(x)$ with the indicated properties. We introduce the function

$$f_\tau(x) = \min(f(x), f_*(x - \tau)).$$

It is continuous and monotonically decreasing. It is easy to see that there exist numbers α and β , $\alpha < \beta$, such that

$$(6.5) \quad f_\alpha(x) = f_*(x - \alpha), \quad f_\beta(x) = f(x).$$

Indeed, by construction $f(x) = f_*(x)$ for $|x| \geq \eta$. Let us set $\alpha = -2\eta$. Then for $-3\eta \leq x \leq -\eta$ we have $f(x) \geq f(-\eta)$, $f_*(x + 2\eta) \leq f(-\eta)$, so that on this interval

$$(6.6) \quad f_*(x - \alpha) \leq f(x).$$

Inequality (6.6) holds outside of this interval, since

$$f_*(x - \alpha) = f(x - \alpha).$$

Thus, inequality (6.6) is valid for all x and, therefore, the first of equations (6.5) is satisfied. By setting $\beta = 2\eta$, we verify, similarly, the validity of the second of equations (6.5). Moreover, we also obtain the inequality

$$(6.7) \quad f_\tau(x) \leq f_*(x - \beta), \quad \alpha \leq \tau \leq \beta.$$

We denote by $u_\tau(x, t)$ the solution of the Cauchy problem for system (2.1) with initial condition

$$u_\tau(x, 0) = f_\tau(x).$$

It is easy to see that for $\tau = \alpha$ the solution of this problem approaches a wave. It follows from property 1) of function $f_*(x)$ and from Theorem 4.1 that the solution $u_*(x, t)$ of the Cauchy problem for system (2.1) with initial condition $f_*(x)$ approaches a wave. But then the solution corresponding to the initial condition $f_\alpha(x) = f_*(x - \alpha)$ approaches the shifted wave. We advance with respect to parameter τ with step h until the value $\tau = \beta$ is attained (for which the initial condition is equal to $f(x)$, by virtue of (6.5)), and we show that at each step there is approach to a wave. Therefore, the theorem is proved.

Thus, along with function $f(x)$ we consider the function $f_{\tau+h}(x)$ ($h > 0$). It follows directly from the definition that

$$f_\tau(x) \leq f_{\tau+h}(x) \leq f_\tau(x - h).$$

By virtue of monotonicity of system (2.1) we obtain

$$u_\tau(x, t) \leq u_{\tau+h}(x + t) \leq u_\tau(x - h, t) \quad (t > 0).$$

It follows from this inequality that

$$(6.8) \quad \|u_{\tau+h}(x, t) - u_\tau(x, t)\| \leq Kh,$$

where the constant K is determined by an estimate of the derivative u'_τ , and $\|\cdot\|$ indicates the C -norm.

Since for all x, t, τ , we have

$$(6.9) \quad w_+ \leq u_\tau(x, t) \leq w_-,$$

then, by virtue of known a priori estimates of the derivatives $u'_\tau(x, t)$ in the C -norm (see §5.1), the constant K in (6.8) does not depend on τ, h, t (for $t > 1$).

We now obtain an estimate in the $\|\cdot\|_\sigma$ -norm. With this in mind, we construct a majorant for the solution $u_\tau(x, t)$. From (6.7), by virtue of the monotonicity of system (2.1), we obtain

$$(6.10) \quad u_\tau(x, t) \leq u_*(x - \beta, t)$$

for all $t > 0, \alpha \leq \tau \leq \beta$. Since u_* approaches a wave in the $\|\cdot\|_\sigma$ -norm, it follows that $u_*(x - \beta, t)$ approaches the shifted wave, i.e.,

$$\|u_*(x - \beta, t) - w(x + \bar{x})\|_\sigma \rightarrow 0 \quad \text{as } t \rightarrow \infty.$$

Here \bar{x} is some number. Therefore there exists a number $T > 0$ such that

$$(6.11) \quad \sup_x |u_*(x - \beta, t) - w(x + \bar{x})| (1 + e^{\sigma x}) < \varepsilon/8$$

for $t > T$. On the other hand, on the basis of (6.2) we have

$$\lim_{x \rightarrow \infty} |w(x + \bar{x}) - w_+|(1 + e^{\sigma x}) = 0,$$

and, therefore, there exists a number $N > 0$, such that

$$(6.12) \quad |w(x + \bar{x}) - w_+|(1 + e^{\sigma x}) < \varepsilon/8$$

for $x > N$. It obviously follows from (6.11) and (6.12) that

$$|u_*(x - \beta, t) - w_+|(1 + e^{\sigma x}) < \varepsilon/4$$

for $x > N, t > T$. Taking inequalities (6.10) and (6.9) into account, we obtain

$$|u_\tau(x, t) - w_+|(1 + e^{\sigma x}) < \varepsilon/4$$

for all $\alpha \leq \tau \leq \beta, x > N, t > T$, whence

$$(6.13) \quad |u_{\tau+h}(x, t) - u_\tau(x, t)|(1 + e^{\sigma x}) < \varepsilon/2$$

for all $x > N, t > T, \alpha \leq \tau \leq \beta - h$.

From (6.8) we have

$$|u_{\tau+h}(x, t) - u_\tau(x, t)|(1 + e^{\sigma x}) \leq Kh(1 + e^{\sigma N})$$

for $x \leq N$. We select h so that the following equality is satisfied:

$$Kh(1 + e^{\sigma N}) = \varepsilon/2.$$

Then inequality (6.13) holds for all $x, t > T, \alpha \leq \tau \leq \beta - h$ (obviously, β and h can be selected so that $f_{\beta-h}(x) = f(x)$).

It is now not difficult to complete the proof of the theorem. Let the solution $u_\tau(x, t)$ approach a wave. Then for some number T_1 we have

$$\|u_\tau(x, t) - w(x + x_1)\|_\sigma < \varepsilon/2$$

for $t > T_1$ (the number x_1 determines the shift of the wave). But then it follows from (6.13) that

$$\|u_\tau(x, t) - w(x + x_1)\|_\sigma < \varepsilon \quad \text{for } t > \max(T, T_1).$$

We now conclude from Theorem 4.1 that $u_{\tau+h}(x, t)$ approaches a wave in the $\|\cdot\|_\sigma$ -norm. This completes the proof of the theorem. \square

We now consider nonmonotone waves. In the scalar case, as is well known, they are unstable (see Chapter 1). Under some additional assumptions, this can be shown to be the case for monotone systems also.

We assume, for a wave, that the limits (6.1) exist, that $w_- > w_+$, and that the wave is nonmonotone. The following lemmas are valid.

LEMMA 6.2. *If all components of the vector-valued function w have no more than a finite number of extrema, we can then find an x for which $w(x) \notin [w_+, w_-]$.*

PROOF. Suppose that the lemma is not valid and that for all $x, w(x) \in [w_+, w_-]$. Then, obviously, $w(x) \in (w_+, w_-)$ and we can find an $h > 0$ such that

$$w(x) > w(x + h), \quad -\infty < x < +\infty.$$

Considering, further, an arbitrary nonmonotone component $w_i(x)$ of the vector-valued function $w(x)$, it is easy to show that for an arbitrary small $\varepsilon > 0$, values of

x can be found such that $w_i(x) < w_i(x + \varepsilon)$. Therefore, an h_0 can be found such that

$$w(x) \geq w(x + h_0), \quad -\infty < x < +\infty,$$

and values i_0 and x_0 for which $w_{i_0}(x_0) = w_{i_0}(x_0 + h_0)$. Since $w_{i_0}(x) \neq w_{i_0}(x + h_0)$, this contradicts theorems of positiveness for parabolic equations. This completes the proof of the lemma. \square

THEOREM 6.2. *If for some x , $w(x) \notin [w_+, w_-]$, the wave $w(x)$ is then unstable in the C -norm.*

PROOF. Assume, for definiteness, that for some i and x_0 , $w_i(x_0) > w_{-i}$. Then, obviously, for some $x = x_1$ the function $w_i(x)$ attains a maximum:

$$w_i(x_1) \geq w_i(x), \quad -\infty < x < +\infty.$$

We introduce the function

$$\tilde{w}(x) = \max(w(x), w(x + \varepsilon)),$$

where ε is some number. If c is the speed of the wave, then $\tilde{w}(x)$ is a lower function for the equation (2.1), i.e., the solution of this equation with initial condition $u(x, 0) = \tilde{w}(x)$ increases monotonically with respect to t for each fixed x . Since the inequality

$$w(x + h) > w(x), \quad -\infty < x < +\infty,$$

cannot be satisfied for any h , then, correspondingly, the following convergence as $t \rightarrow \infty$ cannot be valid:

$$u(x, t) \rightarrow w(x + h), \quad -\infty < x < +\infty.$$

It remains to note that for small ε the quantity $\|\tilde{w}(x) - w(x)\|$ is small, i.e., arbitrary small perturbations exist for which the solution does not tend towards a wave. This completes the proof of the theorem. \square

COROLLARY. *If a wave is nonmonotone and there is at most a finite number of extrema (component wise), the wave is then unstable.*

The proof is obvious.

We note, in conclusion, that the stipulation that the number of extrema be finite is, probably, superfluous.

§7. Minimax representation of the speed

In §4 of Chapter 3 a minimax representation was obtained for the minimal wavespeed c in the case considered there: $c = \omega^*$ (see (4.5)). Here we shall obtain a minimax representation for the wavespeed in other cases also. Let K_σ be the

class of vector-valued functions $\rho(x) \in C^2(-\infty, \infty)$, monotonically decreasing and satisfying the conditions

$$\lim_{x \rightarrow -\infty} \rho(x) = w_-, \quad \lim_{x \rightarrow \infty} |\rho(x) - w_+| e^{\sigma x} = 0.$$

Here $\sigma \geq 0$ is a given number. Further, we let

$$\psi_i(\rho(x)) = -\frac{a_i \rho_i''(x) + F_i(\rho(x))}{\rho_i'(x)},$$

where, as above, a_i are the diagonal elements of matrix a , and F_i are the elements of the vector-valued function F appearing in system (2.1).

We have the following theorem.

THEOREM 7.1. *Let the conditions of Theorem 4.1 be satisfied and assume that (4.2) holds. Then the wavespeed c may be represented in the form*

$$(7.1) \quad c = \inf_{\rho \in K_\sigma} \sup_{\substack{x \in R \\ i=1, \dots, n}} \psi_i(\rho(x)) = \sup_{\rho \in K_\sigma} \inf_{\substack{x \in R \\ i=1, \dots, n}} \psi_i(\rho(x)).$$

PROOF. It follows from (6.1) and (4.2) that wave $w(x) \in K_\sigma$. Therefore, to prove (7.1) it is obviously sufficient to prove the inequalities

$$(7.2) \quad \inf_{x,i} \psi_i(\rho(x)) \leq c \leq \sup_{x,i} \psi_i(\rho(x))$$

for an arbitrary function $\rho(x) \in K_\sigma$. Let us prove the inequality on the right. The inequality on the left is proved similarly.

Suppose that for some $\rho(x) \in K_\sigma$ the right-hand inequality in (7.2) does not hold. Then there exists a number c_0 such that

$$\sup_{x,i} \psi_i(\rho(x)) < c_0 < c.$$

From the form of ψ_i we deduce that

$$(7.3) \quad a \rho''(x) + c_0 \rho'(x) + F(\rho(x)) < 0$$

for all x . Let $\tilde{u}(x, t)$ be a solution of the Cauchy problem for $t > 0$:

$$\frac{\partial \tilde{u}}{\partial t} = a \frac{\partial^2 \tilde{u}}{\partial x^2} + c_0 \frac{\partial \tilde{u}}{\partial x} + F(\tilde{u}), \quad \tilde{u}(x, 0) = \rho(x).$$

By virtue of (7.3) this solution decreases monotonically with respect to t , and we have the inequality

$$(7.4) \quad \tilde{u}(x, t) < \rho(x) \quad \text{for } -\infty < x < +\infty, \quad t > 0.$$

On the other hand, on the basis of Theorem 6.1, the solution $u(x, t)$ of the Cauchy problem for system (2.1), with initial condition $u(x, 0) = f(x)$, approaches a wave, uniformly with respect to x :

$$(7.5) \quad u(x, t) \rightarrow w(x + x_0) \quad \text{as } t \rightarrow \infty.$$

But, obviously, $\tilde{u}(x, t) = u(x - c_1 t, t)$, where $c_1 = c - c_0$. It follows from this, based on (7.4), that $u(-c_1 t, t) < \rho(0)$, so that

$$\lim_{t \rightarrow \infty} u(-c_1 t, t) \leq \rho(0).$$

However, by virtue of (7.5), the indicated limit is equal to w_- , so that $w_- \leq \rho(0)$. But this contradicts the fact that $\rho(x)$ belongs to the class K_σ . The resulting contradiction establishes the theorem. \square

REMARK. The class of functions considered can be broadened. For example, we can assume that $\rho(x)$ has second derivatives discontinuous at a finite number of points. We can also consider continuous piecewise-smooth functions. Here, at the point of discontinuity of the derivatives, we require that the jump of the derivative be of a certain sign.

We give a simple corollary of the theorem, useful in the study of waves.

COROLLARY. *If the inequality $F^*(u) \geq F(u)$ holds for all $u \in \mathbb{R}^n$, we then have the following inequality for the corresponding wavespeeds: $c^* \geq c$.*

In the bistable case in the theorem concerning the minimax representation of the speed, as well as in the theorem concerning the stability of waves, we can set $\sigma = 0$, and Condition S and (4.2) will be satisfied. In the monostable case we cannot always select a σ for which they are satisfied (for example, for $c = \mu_*$, see Theorem 4.2); however, the minimax representation for the minimal speed c_0 is still valid. In §4 of Chapter 3 we proved the equality

$$c_0 = \inf_{\rho \in K_\sigma} \sup_{\substack{x \in R \\ i=1, \dots, n}} \psi_i(\rho(x)).$$

We show that the reciprocal representation

$$(7.6) \quad c_0 = \sup_{\rho \in \tilde{K}} \inf_{\substack{x \in R \\ i=1, \dots, n}} \psi_i(\rho(x))$$

holds, where \tilde{K} is the set of monotonically decreasing vector-valued functions for which the following inequality is satisfied:

$$w(x+h) \geq \rho(x), \quad -\infty < x < +\infty.$$

Here $w(x)$ is a wave with minimal speed and h is an arbitrary number.

Indeed, if we denote the right-hand side of (7.6) by ω_* , then the inequality $c_0 > \omega_*$ cannot hold, since $c_0 \equiv \psi_i(w)$. If $c_0 < \omega_*$, then, selecting c_1 and $\rho(x)$ so that the inequality

$$\inf_{i,x} \psi_i(\rho(x)) > c_1 > c_0$$

holds, we obtain a contradiction analogous to the one we obtained in the proof of the theorem.

We remark, in conclusion, that the functions $\rho(x)$ can be estimated from above, not by waves, but by arbitrary monotone functions for which the solution of the corresponding Cauchy problem tends towards a wave.

Part II

Bifurcation of Waves

Bifurcation of Nonstationary Modes of Wave Propagation

§1. Statement of the problem

We consider the system of equations

$$(1.1) \quad \frac{\partial v}{\partial t} = A\Delta v + F(v, \mu).$$

Here $v = (v_1, v_2, \dots, v_p)$ is a vector-valued function, μ is a real parameter,

$$\Delta v = \sum_{i=1}^N \frac{\partial^2 v}{\partial \xi_i^2},$$

A is a positive-definite square matrix, and $F(v, \mu)$ is a vector-valued function, which we assume to be sufficiently smooth. System (1.1) is considered in cylinder Ω : $\xi = (\xi_1, \xi')$, $-\infty < \xi_1 < +\infty$, $\xi' = (\xi_2, \dots, \xi_N) \in G$, where G is a bounded domain of $(N - 1)$ -dimensional space with a sufficiently smooth boundary. On boundary S of cylinder Ω there is given the boundary condition

$$(1.2) \quad \left. \frac{\partial v}{\partial \nu} \right|_S = 0$$

(ν is the normal to S).

Our interest here is in nonstationary modes of wave propagation, described by the system (1.1), (1.2); these modes appear when a planar wave loses stability. The approach employed here makes it possible, using the same methods, to study both multi-dimensional modes of wave propagation for various G and one-dimensional auto-oscillatory modes. The essence of the approach is that in a system of coordinates, moving with constant speed along the cylinder axis and connected with the front of the wave being studied, the sought-for mode is periodic in time. As we discussed, in an appropriate system of coordinates, in the case of the spinning mode of combustion in a circular cylinder (see the Introduction), a luminous spot moves along a circle; in the case of one-dimensional auto-oscillations a periodic interchange of bursts and depressions takes place, etc. In the solution of a problem, not only profiles of solutions must be determined, but also the rate of propagation of a wave along the cylinder axis and the period of oscillations with respect to the time.

We remark that the studies presented below relate to problem (1.1) without taking into account the specific form of function $F(v, \mu)$. Limitations on nonlinearity are contained implicitly in the assumptions concerning the presence of a planar traveling wave and conditions on the loss of its stability, matters which we shall

discuss below. Such a general approach is justified by the fact that in the simplest cases [Makh 1] these conditions are satisfied, and, secondly, it makes it possible to apply the results obtained for the study of various physical processes.

Presentation of the material is organized as follows. In this chapter solutions of the problem are constructed in the form of formal series, a study is made of their stability, and examples are supplied. Mathematical proofs are contained in the following chapter. Although, with the results presented in this way, it is not possible to avoid the repetition of certain formulations and definitions, nevertheless, it proves to be useful in acquainting the reader not interested in the mathematical side of the problem with the methods and results.

We assume the existence of a planar wave propagating with speed $\tilde{\omega}_\mu$, i.e., a solution of system (1.1) of the form

$$v = \tilde{v}_\mu(\xi_1 - \tilde{\omega}_\mu\tau),$$

so that $\tilde{v}_\mu(\xi)$ is a solution of the system of equations

$$(1.3) \quad A\tilde{v}_\mu''(\xi) + \tilde{\omega}_\mu\tilde{v}_\mu'(\xi) + F(\tilde{v}_\mu, \mu) = 0.$$

Here the prime indicates differentiation with respect to ξ . Moreover, we assume that $\tilde{v}_\mu(\xi)$ is a sufficiently smooth function, having limits, together with its first derivatives, as $\xi \rightarrow \pm\infty$.

Since our interest centers on solutions of equation (1.1) of the type of traveling waves, propagating along the axis of the cylinder, it is convenient to change over to coordinates connected with the front of a wave, i.e., to make the substitution $\xi'_1 = \xi_1 - \omega t$, $\xi'_k = \xi_k$ ($k = 2, 3, \dots, N$) and then return to the previous notation ξ_1, \dots, ξ_N ; in place of (1.1) we then obtain the system

$$(1.4) \quad \frac{\partial v}{\partial t} = A\Delta v + \omega \frac{\partial v}{\partial \xi_1} + F(v, \mu),$$

where ω is the wavespeed. We note that ω is unknown and, like the function v , is to be determined. The planar traveling wave \tilde{v}_μ is a stationary solution of problem (1.4) for $\omega = \tilde{\omega}_\mu$.

The appearance of nonstationary modes of wave propagation is connected with an instability of the planar wave, and the conditions for its appearance are formulated in terms of an eigenvalue problem obtained through linearization of (1.4) about \tilde{v}_μ with $\omega = \tilde{\omega}_\mu$:

$$(1.5) \quad A\Delta w + \tilde{\omega}_\mu \frac{\partial w}{\partial \xi_1} + B_\mu w = \lambda w, \quad \left. \frac{\partial w}{\partial \nu} \right|_S = 0.$$

(Here $B_\mu = F'_v(\tilde{v}_\mu, \mu)$ is the Jacobi matrix.) The point here is that as the parameter μ varies it passes through a critical value μ_0 , i.e., problem (1.5) has eigenvalues satisfying the following condition: for $\mu < \mu_0$ they lie in the left half-plane (have negative real parts); for $\mu > \mu_0$ they lie in the right half-plane. In addition, instability must exhibit an oscillational character, i.e., eigenvalues, found on the imaginary axis for $\mu = \mu_0$, have an imaginary part different from zero, where, for simplicity, we assume that on the imaginary axis there is one pair of complex conjugate eigenvalues. Moreover, problem (1.5) has for all μ , generally speaking, a zero eigenvalue connected with the invariance of a planar wave with respect to translations along ξ_1 . The corresponding eigenfunction is proportional to \tilde{v}'_μ . We denote this eigenfunction for $\mu = \mu_0$ by $\varphi^0(\xi_1)$.

For a more precise statement of the conditions for loss of stability we consider the problem

$$(1.6) \quad A\theta'' - \sigma A\theta + \tilde{\omega}_\mu \theta' + B_\mu \theta = \lambda\theta;$$

θ is a function of ξ_1 , $\theta = \theta(\xi_1)$. The eigenvalues λ for this problem are functions of μ and σ ($\sigma \geq 0$), $\lambda = \lambda(\sigma, \mu)$. In the (σ, μ) -plane we consider a set of points Γ , such that problem (1.6) has for these σ and μ a purely imaginary eigenvalue and has no eigenvalues in the right half-plane. We assume, for definiteness, that for (σ, μ) lying under the curve Γ all the eigenvalues $\lambda(\sigma, \mu)$ of problem (1.6) lie in the left half-plane, but for (σ, μ) lying above Γ there is an eigenvalue in the right half-plane. We assume that curve Γ has a minimum for some $\sigma > 0$. Let $\tilde{\sigma}$ be the abscissa of the point of intersection of curve Γ with the line $\mu = \mu_0$ that is farthest to the right. We assume that for $\sigma = \tilde{\sigma}$ and $\mu < \mu_0$ all the eigenvalues $\lambda(\tilde{\sigma}, \mu)$ of problem (1.6) lie in the left half-plane, and that for $\mu > \mu_0$ there is a $\lambda(\tilde{\sigma}, \mu)$ lying in the right half-plane and $\lambda(\tilde{\sigma}, \mu_0)$ is purely imaginary (we let $\lambda(\tilde{\sigma}, \mu) = i\mathcal{K}$ and assume that it is simple).

Let us point out the relationship of problems (1.5) and (1.6) (for a more precise statement of the conditions for a loss of stability, see the following chapter). If we expand eigenfunctions of problem (1.5) in terms of the eigenfunctions of the Laplace operator in cross-section G of the cylinder,

$$(1.7) \quad \Delta g = -\sigma g, \quad \left. \frac{\partial g}{\partial \nu} \right|_{\partial G} = 0,$$

we then obtain (1.6) for the coefficients of this expansion, where σ runs through all the eigenvalues $\sigma_0 = 0, \sigma_1, \sigma_2, \dots$ of problem (1.7). The eigenvalues of problem (1.5) coincide with the union of the eigenvalues of problem (1.6) for $\sigma = \sigma_k$ ($k = 1, \dots$). Therefore, for some $\sigma_k = \tilde{\sigma}$, problem (1.5) has the eigenvalue $i\mathcal{K}$, and the situation described above for problem (1.5), where the eigenvalue passes through the imaginary axis as μ varies, is realized. Here, as the eigenfunction of problem (1.5) corresponding to $\lambda = i\mathcal{K}$, we have

$$(1.8) \quad \theta(\xi_1)g_k \quad (k = 1, \dots, n),$$

where $\theta(\xi_1)$ is the eigenfunction of problem (1.6) corresponding to $\lambda = \lambda(\tilde{\sigma}, \mu_0) = i\mathcal{K}$; n is the multiplicity of eigenvalue $\tilde{\sigma}$ of problem (1.7); g_1, \dots, g_n are the corresponding eigenfunctions, which we can assume orthogonalized.

We shall seek solutions v of problem (1.4), (1.2), periodic in time, which are close to the planar wave \tilde{v}_μ , appearing as the result of a bifurcation with passage of parameter μ through some value μ_0 (for simplicity, we assume that $\mu_0 = 0$). Here it is convenient to change over to the new variable $\tau = t\rho$, where ρ is a parameter depending on μ , which is to be determined and is chosen so that the solution in the new variables will have period 2π . We obtain the system

$$(1.9) \quad \rho \frac{\partial v}{\partial \tau} = A\Delta v + \omega \frac{\partial v}{\partial \xi_1} + F(v, \mu).$$

Thus, our interest centers on questions concerning the existence and uniqueness of solutions of system (1.9), solutions which are of period 2π with respect to the time; we shall also be interested in the form and stability of these solutions to small perturbations for various geometric configurations.

In what follows we shall need an expansion of $F(v, \mu)$ with respect to v and μ in a neighborhood of $v = \tilde{v}_\mu$, $\mu = 0$. It has the form

$$(1.10) \quad F(\tilde{v}_\mu + w, \mu) = F(\tilde{v}_\mu, \mu) + (B_0 + \mu \dot{B}_0)w + \alpha_2(w) + \alpha_3(w) + \cdots,$$

where $\dot{B}_0 = \partial B_\mu / \partial \mu|_{\mu=0}$, α_2 and α_3 are quadratic and cubic terms taken at $\mu = 0$ and generated by bilinear and trilinear symmetric forms $\hat{\alpha}_2$ and $\hat{\alpha}_3$:

$$\alpha_2(v) = \hat{\alpha}_2(v, v), \quad \alpha_3(v) = \hat{\alpha}_3(v, v, v).$$

In studying periodic solutions of problem (1.9) we shall assume that the sought-for solution is close to a planar wave and we seek it in the form of a series in powers of a small parameter. The leading term in the expansion of the solution $v - \tilde{v}_\mu$ satisfies problem (1.9), linearized on \tilde{v}_0 , and the succeeding terms satisfy corresponding linear nonhomogeneous equations.

We consider first problem (1.9), linearized on \tilde{v}_0 , having the form

$$(1.11) \quad Lv \equiv A\Delta v - \rho_0 \frac{\partial v}{\partial \tau} + \tilde{\omega}_0 \frac{\partial v}{\partial \xi_1} + B_0 v = 0,$$

where ρ_0 denotes the value of ρ at $\mu = 0$.

We consider equation (1.11) and find all of its solutions. We recall that ρ_0 , as well as v , is unknown. We assume that $\rho_0 \neq 0$.

It may be verified directly that the solutions of equation (1.11) are

$$(1.12) \quad \rho_0 \text{ -arbitrary,} \quad v_0 = \varphi^0 / (2\pi)^{1/2},$$

$$(1.13) \quad \begin{cases} \rho_0 = \varkappa, & v_k(\xi, \tau) = \theta(\xi_1) g_k(\xi') \exp(i\tau) / (2\pi)^{1/2}, \\ \bar{v}_k(\xi, \tau) = \bar{\theta}(\xi_1) g_k(\xi') \exp(-i\tau) / (2\pi)^{1/2} & (k = 1, 2, \dots, n). \end{cases}$$

(Here the overbar indicates the complex conjugate.)

In fact, the following are also solutions:

$$(1.14) \quad \begin{cases} \rho_0 = \varkappa/m, & v_k(\xi, \tau) = \theta(\xi_1) g_k(\xi') \exp(im\tau) / (2\pi)^{1/2}, \\ \bar{v}_k(\xi, \tau) = \bar{\theta}(\xi_1) g_k(\xi') \exp(-im\tau) / (2\pi)^{1/2} & (k = 1, 2, \dots, n) \end{cases}$$

for all integers $m \neq 0$. We can, however, restrict ourselves to the solutions (1.13) since, if in (1.14) we return to the initial variable, we obtain $m\tau = \varkappa t$ for all m . Solution (1.12) also does not play an essential role since, as shown in the following chapter, selection of a suitable translation with respect to ξ_1 allows us to not take (1.12) into account.

Equation (1.11) has no other linearly independent solutions except those indicated. In what follows, we shall assume that $\rho_0 = \varkappa$.

We consider the equation adjoint to (1.11):

$$(1.15) \quad L^* \varphi = 0,$$

where

$$L^* \varphi = A\Delta \varphi + \rho_0 \frac{\partial \varphi}{\partial \tau} - \tilde{\omega}_0 \frac{\partial \varphi}{\partial \xi_1} + B_0^* \varphi.$$

All the linearly independent solutions of equation (1.15) have the form

$$(1.16) \quad \begin{cases} \varphi_0(\xi, \tau) = \psi_0(\xi_1) / (2\pi)^{1/2}, & \varphi_k(\xi, \tau) = \psi(\xi_1) g_k(\xi') \exp(i\tau) / (2\pi)^{1/2}, \\ \bar{\varphi}_k(\xi, \tau) = \overline{\psi(\xi_1) g_k(\xi')} \exp(-i\tau) / (2\pi)^{1/2}, & (k = 1, 2, \dots, n), \end{cases}$$

where ψ_0 and ψ are solutions of the equations

$$\begin{aligned} A\psi'' - \tilde{\sigma}A\psi - \tilde{\omega}_0\psi' + B_0^*\psi &= -i\mathcal{K}\psi, \\ A\psi_0'' - \tilde{\omega}_0\psi_0' + B_0^*\psi_0 &= 0, \end{aligned}$$

B_μ^* is the matrix adjoint to B_μ .

We introduce the inner product

$$\langle v, \varphi \rangle = \int_0^{2\pi} d\tau \int_\Omega (v(\xi, \tau), \varphi(\xi, \tau)) d\xi.$$

We can assume that functions u_k and φ_k ($k = 0, 1, \dots, n$) are normalized in such a way that

$$\begin{aligned} \langle v_m, \varphi_s \rangle &= \delta_{ms} & (s, m = 0, 1, \dots, n), \\ \langle v_m, \bar{\varphi}_s \rangle &= 0 & (s, m = 0, 1, \dots, n). \end{aligned}$$

In concluding this section we mention that for solvability of the equation $Lv = f$ it is necessary and sufficient that the following conditions be satisfied:

$$\begin{aligned} \langle f, \varphi_k \rangle &= 0 & (k = 0, 1, \dots, n), \\ \langle f, \bar{\varphi}_k \rangle &= 0 & (k = 0, 1, \dots, n). \end{aligned}$$

§2. Representation of solutions in series form. Stability of solutions

We seek solutions of problem (1.9), (1.2) in the form of series in powers of a small parameter α :

$$(2.1) \quad \begin{aligned} v &= \tilde{v}_\mu + \alpha y_1 + \alpha^2 y_2 + \alpha^3 y_3 + \dots, & \rho &= \kappa + \alpha \rho_1 + \alpha^2 \rho_2 + \dots, \\ \omega &= \tilde{\omega}_\mu + \alpha \omega_1 + \alpha^2 \omega_2 + \alpha^3 \omega_3 + \dots, & \mu &= \alpha \mu_1 + \alpha^2 \mu_2 + \dots. \end{aligned}$$

Here y_i are unknown real functions of τ, ξ_1, ξ' (ξ' are coordinates in G), and are 2π -periodic in τ and satisfy the boundary condition

$$\left. \frac{\partial y_i}{\partial \nu} \right|_S = 0 \quad (i = 1, 2, \dots).$$

All the coefficients of the expansions are unknown and are to be determined. We substitute (2.1) into (1.9) and collect terms with like powers of α , and then equate the expressions obtained to zero.

Collecting terms with α^1 , we obtain the equation

$$(2.2) \quad Ly_1 = -\omega_1 \tilde{v}'_0.$$

The condition for orthogonality of the right-hand side of (2.2) to φ_0 yields $\omega_1 = 0$ and, consequently, y_1 is a solution of equation (1.11). The function y_1 , being real, has the form

$$(2.3) \quad y_1 = \chi_1 v_1 + \chi_2 v_2 + \dots + \chi_n v_n + \overline{\chi_1 v_1} + \overline{\chi_2 v_2} + \dots + \overline{\chi_n v_n},$$

where χ_1, \dots, χ_n are complex constants which we can assume to be normalized,

$$(2.4) \quad |\chi_1|^2 + \dots + |\chi_n|^2 = 1,$$

and which must be determined from further considerations.

Collecting terms with α^2 , we obtain the equation

$$(2.5) \quad Ly_2 = -\mu_1 T y_1 + \rho_1 \frac{\partial y_1}{\partial \tau} - \omega_2 \tilde{v}'_0 - \alpha_2(y_1).$$

Here T is given by the expression

$$Tv = \dot{\tilde{\omega}}_0 \frac{\partial v}{\partial \xi_1} + \dot{B}_0 v,$$

where we have introduced the notation

$$\dot{\tilde{\omega}}_0 = \left. \frac{d\tilde{\omega}_\mu}{d\mu} \right|_{\mu=0}, \quad \dot{B}_0 = \left. \frac{dB_\mu}{d\mu} \right|_{\mu=0}.$$

Taking the inner product of (2.5) with

$$(2.6) \quad \varphi = \chi_1 \varphi_1 + \chi_2 \varphi_2 + \cdots + \chi_n \varphi_n,$$

we find that $\mu_1 = \rho_1 = 0$. Indeed

$$\langle \alpha_2(y_1), \varphi \rangle = \langle \tilde{v}'_0, \varphi \rangle = 0$$

since the corresponding integrals with respect to τ are equal to zero,

$$\langle \partial y_1 / \partial \tau, \varphi \rangle = i \langle \chi_1 v_1 + \cdots + \chi_n v_n - \overline{\chi_1 v_1} - \cdots - \overline{\chi_n v_n}, \varphi \rangle = i,$$

$$\langle T y_1, \varphi \rangle = \sum_{j=1}^n |\chi_j|^2 \langle T v_j, \varphi_j \rangle = \dot{\lambda},$$

where we have used the equality

$$\langle T v_1, \varphi_1 \rangle = \cdots = \langle T v_n, \varphi_n \rangle = \dot{\lambda}.$$

Here

$$\dot{\lambda} = \left. \frac{d\lambda_\mu}{d\mu} \right|_{\mu=0},$$

λ_μ is the eigenvalue which moves from the left half-plane into the right half-plane as μ varies, as discussed earlier; $\lambda_0 = i\mathcal{X}$.

Thus, $i\rho_1 - \mu_1 \dot{\lambda} = 0$, whence, noting that $\text{Re } \dot{\lambda} \neq 0$, it follows that $\mu_1 = \rho_1 = 0$. For y_2 we then obtain the equation

$$(2.7) \quad Ly_2 = -\omega_2 \tilde{v}'_0 - \alpha_2(y_1),$$

ω_2 is obtained from the condition that the right-hand side of (2.7) is orthogonal to φ_0 ,

$$(2.8) \quad \omega_2 = -\langle \alpha_2(y_1), \varphi_0 \rangle.$$

The conditions of orthogonality of the right-hand side of (2.7) to $\varphi_j, \overline{\varphi_j}$ are satisfied and, therefore, equation (2.7) is solvable for y_2 . We note that the solution of equation (2.7) is determined to within a solution of the homogeneous equation (1.11), i.e.,

$$(2.9) \quad y_2 = \hat{y}_2 + \overset{0}{y}_2, \quad \langle \hat{y}_2, \varphi_j \rangle = \langle \hat{y}_2, \overline{\varphi_j} \rangle = 0, \\ \overset{0}{y}_2 = \chi'_1 v_1 + \chi'_2 v_2 + \cdots + \chi'_n v_n + \overline{\chi'_1 v_1} + \overline{\chi'_2 v_2} + \cdots + \overline{\chi'_n v_n},$$

where χ'_1, \dots, χ'_n are complex constants.

Collecting terms with α^3 , we obtain the equation

$$(2.10) \quad Ly_3 + \omega_3 \tilde{v}'_0 + \Pi = 0,$$

$$(2.11) \quad \Pi \equiv \mu_2 T y_1 - \rho_2 \partial y_1 / \partial \tau + \omega_2 \partial y_1 / \partial \xi_1 + 2\hat{\alpha}_2(y_1, y_2) + \alpha_3(y_1).$$

Taking the inner product of (2.10) with φ_0 and noting that $\langle \Pi, \varphi_0 \rangle = 0$, we obtain $\omega_3 = 0$. Taking the inner product of (2.10) with φ , given by formula (2.6), we obtain

$$i\rho_2 - \dot{\lambda}\mu_2 = \langle \omega_2 \partial y_1 / \partial \xi_1 + 2\hat{\alpha}_2(y_1, \hat{y}_2) + \alpha_3(y_1), \varphi \rangle \equiv I,$$

since

$$\langle \hat{\alpha}_2(y_1, \hat{y}_2), \varphi_j \rangle = 0 \quad (j = 1, 2, \dots, n).$$

It follows from this that μ_2 and ρ_2 can be found in terms of χ_k :

$$(2.12) \quad \mu_2 = -\operatorname{Re} I / \operatorname{Re} \dot{\lambda}, \quad \rho_2 = \operatorname{Im} I - \operatorname{Re} I \operatorname{Im} \dot{\lambda} / \operatorname{Re} \dot{\lambda}.$$

The conditions

$$(2.13) \quad \Pi_j \equiv \langle \Pi, \varphi_j \rangle = 0 \quad (j = 1, 2, \dots, n),$$

together with the normalization condition (2.4), allows us to obtain χ_1, \dots, χ_n . Thus, we have $2n + 1$ real equations (we can replace n of the complex equations (2.13) by $2n$ real equations) in $2n + 2$ real unknowns

$$\mu_2, \rho_2, \operatorname{Re} \chi_1, \operatorname{Im} \chi_1, \dots, \operatorname{Re} \chi_n, \operatorname{Im} \chi_n.$$

Presence of the extra unknown is due to the fact that problem (1.9) is invariant with respect to translations in τ , and, consequently, we must obtain an entire family of solutions (2.4), (2.13), which is, in fact, provided by the extra unknown. We note that from the family of solutions of (1.9) we could select a representative (by making a translation in τ) such that one of the unknowns χ_k would be real. We would then have $2n + 1$ equations in $2n + 1$ unknowns.

Equations (2.13) are fairly complicated and, as the examples presented below show, can have a different number of families of solutions; nevertheless, the form of Π_j can be determined. We let

$$(2.14) \quad Q_j \equiv Q_j(\chi_1, \bar{\chi}_1, \dots, \chi_n, \bar{\chi}_n) = \langle \omega_2 \partial y_1 / \partial \xi_1 + 2\hat{\alpha}_2(y_1, y_2) + \alpha_3(y_1), \varphi_j \rangle.$$

It is then easy to verify that

$$\Pi_j = \chi_j \mu_2 \dot{\lambda} - \chi_j i \rho_2 + Q_j.$$

We verify also that we have the equation

$$(2.15) \quad Q_j(\chi_1 \gamma, \bar{\chi}_1 \bar{\gamma}, \dots, \chi_n \gamma, \bar{\chi}_n \bar{\gamma}) = |\gamma|^2 \gamma Q_j(\chi_1, \bar{\chi}_1, \dots, \chi_n, \bar{\chi}_n)$$

for arbitrary complex γ and arbitrary χ_1, \dots, χ_n . We let

$$\gamma = |\gamma| \exp(-i\delta), \quad \tilde{y}_k(\tau, \xi_1, \xi') = y_k(\tau + \delta, \xi_1, \xi') \quad (k = 1, 2).$$

Then

$$\tilde{y}_1 = (\chi_1 v_1 + \dots + \chi_n v_n) \exp(i\delta) + (\bar{\chi}_1 \bar{v}_1 + \dots + \bar{\chi}_n \bar{v}_n) \exp(-i\delta).$$

Making a translation by δ with respect to τ in (2.7), we find that to the vector

$$(\chi_1 \gamma, \bar{\chi}_1 \bar{\gamma}, \dots, \chi_n \gamma, \bar{\chi}_n \bar{\gamma})$$

there correspond $|\gamma|^2 \tilde{y}_2$ and $|\gamma|^2 \omega_2$. Therefore,

$$\begin{aligned} Q_j(\chi_1 \gamma, \overline{\chi_1 \gamma}, \dots, \chi_n \gamma, \overline{\chi_n \gamma}) &= \langle \omega_2 |\gamma|^3 \partial \tilde{y}_1 / \partial \xi_1 + 2\hat{\alpha}_2 (|\gamma| \tilde{y}_1, |\gamma|^2 \tilde{y}_2) + \alpha_3 (|\gamma| \tilde{y}_1), \varphi_j \rangle \\ &= |\gamma|^3 \langle \omega_2 \partial y_1 / \partial \xi_1 + 2\hat{\alpha}_2 (y_1, y_2) + \alpha_3 (y_1), g_j \psi \exp i(\tau + \delta) \rangle \\ &= |\gamma|^3 \exp(-i\delta) \langle \omega_2 \partial y_1 / \partial \xi_1 + 2\hat{\alpha}_2 (y_1, y_2) + a_3 (y_1), \varphi_j \rangle \\ &= |\gamma|^2 \gamma Q_j(\chi_1, \overline{\chi_1}, \dots, \chi_n, \overline{\chi_n}). \end{aligned}$$

It follows from (2.15) that Q_j is a cubic form in $(\chi_1, \overline{\chi_1}, \dots, \chi_n, \overline{\chi_n})$, where each of its terms has the form $\chi_i \chi_l \overline{\chi_k} \zeta_{jilk}$. Thus,

$$(2.16) \quad Q_j = \sum_{l>i, i,k=1}^n \chi_i \chi_l \overline{\chi_k} \zeta_{jilk}.$$

The coefficients ζ_{jilk} in (2.16) can be found as derivatives of Q_j with respect to $\chi_i \chi_l \overline{\chi_k}$:

$$(2.17) \quad \begin{aligned} \zeta_{jilk} &= \frac{\partial^3 Q_j}{\partial \chi_i \partial \chi_l \partial \overline{\chi_k}} \\ &= \left\langle \frac{\partial^2 \omega_2}{\partial \chi_i \partial \chi_l} \frac{\partial}{\partial \xi_1} \left(\frac{\partial y_1}{\partial \overline{\chi_k}} \right) + \frac{\partial^2 \omega_2}{\partial \chi_i \partial \overline{\chi_k}} \frac{\partial}{\partial \xi_1} \left(\frac{\partial y_1}{\partial \chi_l} \right) \right. \\ &\quad + \frac{\partial^2 \omega_2}{\partial \chi_l \partial \overline{\chi_k}} \frac{\partial}{\partial \xi_1} \left(\frac{\partial y_1}{\partial \chi_i} \right) + 2\hat{\alpha}_2 \left(\frac{\partial y_1}{\partial \chi_i}, \frac{\partial^2 y_2}{\partial \chi_l \partial \overline{\chi_k}} \right) + 2\hat{\alpha}_2 \left(\frac{\partial y_1}{\partial \chi_l}, \frac{\partial^2 y_2}{\partial \chi_i \partial \overline{\chi_k}} \right) \\ &\quad \left. + 2\hat{\alpha}_2 \left(\frac{\partial y_1}{\partial \overline{\chi_k}}, \frac{\partial^2 y_2}{\partial \chi_i \partial \chi_l} \right) + 6\hat{\alpha}_3 \left(\frac{\partial y_1}{\partial \chi_i}, \frac{\partial y_1}{\partial \chi_l}, \frac{\partial y_1}{\partial \overline{\chi_k}} \right), \varphi_j \right\rangle, \end{aligned}$$

where

$$\partial y_1 / \partial \chi_i = v_i, \quad \partial y_1 / \partial \chi_l = v_l, \quad \partial y_1 / \partial \overline{\chi_k} = \overline{v_k};$$

the second derivatives of y_2 satisfy equations of the form

$$\frac{\partial^2 y_2}{\partial \chi_i \partial \chi_l} + \frac{\partial^2 \omega_2}{\partial \chi_i \partial \chi_l} \tilde{v}'_0 + 2\hat{\alpha}_2 \left(\frac{\partial y_1}{\partial \chi_i}, \frac{\partial y_1}{\partial \chi_l} \right) = 0$$

and conditions of orthogonality to $\varphi_j, \overline{\varphi}_j$ ($j = 0, 1, \dots, n$). The representation of Q_j in the form (2.16), (2.17) proves to be, in a number of cases, more suitable for calculations than (2.14).

The identity (2.15) yields the following formulas, useful later on:

$$(2.18) \quad \sum_{k=1}^n \chi_k \frac{\partial Q_j}{\partial \chi_k} = 2Q_j, \quad \sum_{k=1}^n \overline{\chi_k} \frac{\partial Q_j}{\partial \overline{\chi_k}} = Q_j.$$

They are obtained by differentiating (2.15) with respect to γ and $\overline{\gamma}$, respectively, and setting $\gamma = 1$.

Writing out the terms for successive powers of α yields equations for coefficients of the expansions (2.1) from which, in principle, they can be obtained. We shall not concern ourselves with this now, but we point out that in the following chapter a theorem is proved asserting the possibility of representing solutions of problem (1.9) in the form (2.1), as well as establishing the existence and uniqueness of a solution

with leading term y_1 of the form (2.3), where χ_1, \dots, χ_n satisfy (2.4), (2.13) proving that some determinant $\mathcal{J}(\chi_1, \dots, \chi_n)$ is different from zero.

We proceed now to a clarification of the stability of solutions of problem (1.9) bifurcating from a planar wave. Problem (1.9), linearized about

$$v = \tilde{v}_\mu + y, \quad y \equiv \alpha y_1 + \alpha^2 y_2 + \dots,$$

has the form

$$(2.19) \quad \Lambda(\alpha)w \equiv -\rho \frac{\partial w}{\partial \tau} + A\Delta w + \omega \frac{\partial w}{\partial \xi} + B_0 w + \mu \dot{B}_0 w + 2\hat{\alpha}_2(w, y) + 3\hat{\alpha}_3(w, y, y) + \dots = \lambda w.$$

Operator $\Lambda(0)$ coincides with operator L considered above; therefore, we know that $\Lambda(0)$ has a zero eigenvalue of multiplicity $2n + 1$ with eigenfunctions (1.12), (1.13), and the remaining eigenvalues lie in the left half-plane. For small α only those eigenvalues of problem (2.19) can be found in the right half-plane which branch out from the zero eigenvalue for $\alpha = 0$. We note that problem (2.19) has for $\alpha > 0$ a multiple zero eigenvalue with eigenfunctions $\partial v / \partial \xi_1$ and $\partial v / \partial \tau$, a circumstance connected with the invariance of problem (1.9) with respect to translations in ξ_1 and τ . Thus, we must follow the motion of the remaining $2n - 1$ eigenvalues as α varies. We could seek eigenvalues λ of problem (2.19) in the form of a series in powers of α :

$$(2.20) \quad \lambda = \alpha^2 \lambda_2 + \dots,$$

and, correspondingly, eigenfunctions in the form

$$w = \alpha w_1 + \alpha^2 w_2 + \dots$$

Our interest here centers on the signs of $\text{Re } \lambda_2$ for all eigenvalues λ branching away from the zero eigenvalue, since they determine the stability or instability of solution v of problem (1.9). It turns out (see the following chapter) that all λ_2 , except for one, equal to zero, to which there corresponds the eigenfunction $\partial v / \partial \xi$, are eigenvalues of matrix \mathcal{D} ,

$$\mathcal{D} = \begin{pmatrix} \frac{\partial \Pi_1}{\partial \chi_1} & \frac{\partial \Pi_1}{\partial \bar{\chi}_1} & \frac{\partial \Pi_1}{\partial \chi_2} & \frac{\partial \Pi_1}{\partial \bar{\chi}_2} & \dots & \frac{\partial \Pi_1}{\partial \chi_n} & \frac{\partial \Pi_1}{\partial \bar{\chi}_n} \\ \frac{\partial \Pi_1}{\partial \chi_1} & \frac{\partial \Pi_1}{\partial \bar{\chi}_1} & \frac{\partial \Pi_1}{\partial \chi_2} & \frac{\partial \Pi_1}{\partial \bar{\chi}_2} & \dots & \frac{\partial \Pi_1}{\partial \chi_n} & \frac{\partial \Pi_1}{\partial \bar{\chi}_n} \\ \dots & \dots & \dots & \dots & \dots & \dots & \dots \\ \frac{\partial \Pi_n}{\partial \chi_1} & \frac{\partial \Pi_n}{\partial \bar{\chi}_1} & \frac{\partial \Pi_n}{\partial \chi_2} & \frac{\partial \Pi_n}{\partial \bar{\chi}_2} & \dots & \frac{\partial \Pi_n}{\partial \chi_n} & \frac{\partial \Pi_n}{\partial \bar{\chi}_n} \end{pmatrix}.$$

We verify that \mathcal{D} has a zero eigenvalue and eigenvalue $\lambda_2 = -2\mu_2 \text{Re } \dot{\lambda}$. We denote by e and d , respectively, the columns

$$\begin{aligned} & (\chi_1, -\bar{\chi}_1, \chi_2, -\bar{\chi}_2, \dots, \chi_n, -\bar{\chi}_n), \\ & (\chi_1(-i\rho_2 + \mu_2 \dot{\lambda}), \bar{\chi}_1(i\rho_2 + \mu_2 \dot{\lambda}), \dots, \chi_n(-i\rho_2 + \mu_2 \dot{\lambda}), \bar{\chi}_n(i\rho_2 + \mu_2 \dot{\lambda})), \end{aligned}$$

and, using the definitions of the quantities Π_j and Q_j , and also the identities (2.18), we obtain

$$\mathcal{D}e = 0, \quad \mathcal{D}d = -2\mu_2 \text{Re } \dot{\lambda} d,$$

which is what we wished to prove. It follows from this that subcritical bifurcations are unstable, both in the case of simple eigenvalues $\tilde{\sigma}$ and in the case of multiple eigenvalues.

§3. Examples

Now we consider some examples. We begin with the case of the simple eigenvalue $\tilde{\sigma}$. In this case $n = 1$ and in expansion (2.1)

$$y_1 = \chi_1 v_1 + \bar{\chi}_1 \bar{v}_1, \quad |\chi_1| = 1$$

(see (2.3), (2.4)). The equation for y_2 can be written in the form (see (2.7))

$$(3.1) \quad \begin{aligned} &Ly_2 + \omega_2 \tilde{v}'_0 + \chi_1^2 g_1^2 \frac{1}{2\pi} \exp(2i\tau) \alpha_2(\theta) \\ &+ \bar{\chi}_1^2 g_1^2 \frac{1}{2\pi} \exp(-2i\tau) \alpha_2(\bar{\theta}) + \frac{1}{\pi} |\chi_1|^2 g_1^2 \hat{\alpha}_2(\theta, \bar{\theta}) = 0, \end{aligned}$$

and, consequently,

$$(3.2) \quad \begin{aligned} \omega_2 &= -2 \int_G [g_1(\xi')]^2 d\xi' \int_{-\infty}^{\infty} \langle \hat{\alpha}(\theta, \bar{\theta}), \varphi_0 \rangle d\xi_1, \\ y_2(\theta, \xi_1, \xi') &= \chi_1^2 \exp(2i\tau) \zeta_1(\xi_1, \xi') \\ &+ \bar{\chi}_1^2 \exp(-2i\tau) \bar{\zeta}_1(\xi_1, \xi') + 2|\chi_1|^2 \zeta_2(\xi_1, \xi'), \end{aligned}$$

where the equations for $\zeta_1(\xi_1, \xi')$, $\zeta_2(\xi_1, \xi')$ can be readily obtained by substituting (3.2) into (3.1). As was shown above,

$$\omega_1 = \rho_1 = \mu_1 = \omega_3 = 0,$$

and the conditions (2.13) for solvability of equation (2.10) for y_3 have in this case the form

$$(3.3) \quad \Pi_1 \equiv -i\chi_1 \rho_2 + \mu_2 \dot{\lambda} \chi_1 + \chi_1 |\chi_1|^2 \zeta = 0,$$

where (see (2.17))

$$\begin{aligned} \zeta &= \zeta_{1111} = \frac{\partial^3 Q_1}{\partial \chi_1^2 \partial \bar{\chi}_1} \\ &= \int_G \int_{-\infty}^{\infty} \left(\omega_2 \frac{\partial \theta}{\partial \xi_1} g_1 + 4g_1 \hat{\alpha}_2(\theta, \zeta_2) + 2g_1 \hat{\alpha}_2(\theta, \zeta_1) + \frac{3}{\pi} g_1^3 \hat{\alpha}_3(\theta, \theta, \bar{\theta}), \psi g_1 \right) d\xi_1 d\xi'. \end{aligned}$$

From this we have (see (3.3))

$$(3.4) \quad \mu_2 = -\operatorname{Re} \zeta / \operatorname{Re} \dot{\lambda}, \quad \rho_2 = \operatorname{Im} \zeta + \mu_2 \operatorname{Im} \dot{\lambda}.$$

We show also that the determinant $\mathcal{J}(\chi_1)$ for $n = 1$ is not equal to zero, and, therefore, the solution of problem (1.9), (1.2) of the form (2.1), with the indicated $y_1, y_2, \omega_1, \omega_2$, etc., exists and is unique for each χ_1 . All these solutions, corresponding to various χ_1 , can be changed over into one another by translations in τ .

The general results presented above concerning the stability of solutions of problem (1.9), (1.2), branching from a planar wave, make it possible to assert that subcritical bifurcations ($\mu_2 < 0$, see (3.4)) are unstable and that supercritical ones are stable.

The conditions discussed allow us to make certain deductions concerning properties of the solutions obtained. Thus, for example, if eigenvalue $\tilde{\sigma}$ is equal to zero, then $n = 1$ and $g_1 \equiv 1$. Consequently, y_1 does not depend on ξ' and, from the form of the equations for y_k ($k = 2, 3, \dots$), we find that y_2, y_3 , etc., and, together with them, also v do not depend on ξ' . Thus we obtain one-dimensional self-oscillating modes.

By way of a second example, we can consider the case of a circular cylinder where $\tilde{\sigma} = (\sigma_{0n}/R)^2$. Then y_1 is independent of the angular coordinate, and the same conclusion can be made concerning solution v (limiting modes in a circular cylinder).

The case of a multiple eigenvalue $\tilde{\sigma}$ is complicated. We can say that Q_j , as a consequence of (2.16), has the form

$$(3.5) \quad Q_j = \chi_1|\chi_1|^2\zeta_{j1} + \chi_1|\chi_2|^2\zeta_{j2} + \chi_2|\chi_1|^2\zeta_{j3} + \chi_2|\chi_2|^2\zeta_{j4} + \bar{\chi}_1\chi_2^2\zeta_{j5} + \bar{\chi}_2\chi_1^2\zeta_{j6}.$$

We consider two examples: one in which domain G is a disk of radius R in which polar coordinates r, φ are introduced, and the second in which G is a square of side l .

In the first case, y_1 in (2.1) has the form

$$y_1 = \chi_1 v_1 + \chi_2 v_2 + \overline{\chi_1 v_1} + \overline{\chi_2 v_2}, \quad |\chi_1|^2 + |\chi_2|^2 = 1;$$

v_1, v_2 are given by formula (1.13) with

$$g_1 = \exp(-ik\varphi)J_k(\sigma_{kl}R/R), \quad g_2 = \exp(ik\varphi)J_k(\sigma_{kl}r/R) \quad (k, l > 0),$$

y_2 and ω_2 have the form

$$(3.6) \quad \begin{aligned} y_2(\tau, \xi, r, \varphi) = & \chi_1^2\zeta_1 \exp 2i(\tau - k\varphi) + \chi_2^2\zeta_1 \exp 2i(\tau + k\varphi) + 2\zeta_4 \\ & + 2\chi_1\bar{\chi}_2\zeta_2 \exp(-2ik\varphi) + 2\chi_1\chi_2\zeta_3 \exp(2i\tau) + \bar{\chi}_1^2\bar{\zeta}_1 \exp(-2i(\tau - k\varphi)) \\ & + \bar{\chi}_2^2\bar{\zeta}_1 \exp(-2i(\tau + k\varphi)) + 2\bar{\chi}_1\chi_2\bar{\zeta}_2 \exp(2ik\varphi) + 2\bar{\chi}_1\bar{\chi}_2\bar{\zeta}_3 \exp(-2i\tau), \end{aligned}$$

$$(3.7) \quad \omega_2 = -8\pi^2(\chi_1\bar{\chi}_1 + \chi_2\bar{\chi}_2) \int_0^R J_k^2(\sigma_{kl}r/R) dr \int_{-\infty}^{\infty} (\alpha_2(\theta), \varphi_0) d\xi,$$

where $\zeta_k(\xi)$ ($k = 1, \dots, 4$) satisfy the equations obtained by the substitution of (3.6), (3.7) into (2.7). Conditions (2.13) for the solvability of equations (2.10) for y_3 have, in this case, the form

$$(3.8) \quad \begin{aligned} \Pi_1 \equiv & -i\chi_1\rho_2 + \mu_2\dot{\lambda}\chi_1 + \chi_1|\chi_1|^2\zeta_1 + \chi_1|\chi_2|^2\zeta_2 = 0, \\ \Pi_2 \equiv & -i\chi_2\rho_2 + \mu_2\dot{\lambda}\chi_2 + \chi_2|\chi_2|^2\zeta_1 + \chi_2|\chi_1|^2\zeta_2 = 0, \end{aligned}$$

where $\zeta_1 = \partial^3 Q_1 / \partial \chi_1^2 \partial \bar{\chi}_1$, $\zeta_2 = \partial^3 Q_1 / \partial \chi_1 \partial \bar{\chi}_2 \partial \chi_2$, and can be calculated in accordance with formulas (2.17), and, by the same formulas, we may verify that in (3.5) $\zeta_{j3} = \zeta_{j4} = \zeta_{j5} = \zeta_{j6} = 0$. In fact, we can obtain the equality of these coefficients to zero without any calculations by using the invariance of problem (1.9), (1.2) in the circular cylinder with respect to translations in τ and rotations with respect to φ . With respect to the use of groups of symmetries in the theory of bifurcations see also [Sat 3].

It is easy to see that equations (3.8) have the solutions

$$\begin{aligned} 1^\circ. \quad |\chi_1| = 1, \quad \chi_2 = 0; \quad 2^\circ. \quad |\chi_2| = 1, \quad \chi_1 = 0; \\ 3^\circ. \quad |\chi_1| = |\chi_2| = 2^{-1/2}. \end{aligned}$$

The first two cases correspond to spinning modes rotating in different directions, and the third case, obtained under the condition $\zeta_1 \neq \zeta_2$, corresponds to symmetric modes. In cases 1° and 2° , as a consequence of (3.8),

$$(3.9) \quad \mu_2 = -\operatorname{Re} \zeta_1 / \operatorname{Re} \dot{\lambda}, \quad \rho_2 = \mu_2 \operatorname{Im} \dot{\lambda} + \operatorname{Im} \zeta_1,$$

while in case 3° ,

$$\mu_2 = -\operatorname{Re}(\zeta_1 + \zeta_2) / (2 \operatorname{Re} \dot{\lambda}), \quad \rho_2 = \mu_2 \operatorname{Im} \dot{\lambda} + \operatorname{Im}(\zeta_1 + \zeta_2) / 2.$$

We remark that in cases 1° and 2° determinant $\mathcal{J}(\chi_1, \chi_2) \neq 0$, and, consequently, the solution exists and is unique for arbitrary χ_1 and χ_2 satisfying 1° , 2° . In case 3° , $\mathcal{J}(\chi_1, \chi_2) = 0$ and the elucidation of questions of existence and uniqueness of a solution required additional investigations [Vol 49].

A study of the stability of solutions, corresponding to cases 1° – 3° , is reduced, as noted above, to finding the eigenvalues of the matrix $\mathcal{D} = \mathcal{D}(\chi_1, \chi_2)$. In cases 1° and 2° the matrices $\mathcal{D}(\chi_1, 0)$ and $\mathcal{D}(0, \chi_2)$ have identical eigenvalues $\lambda = \alpha^2 \lambda_2 + \dots$, where

$$(3.10) \quad \lambda_2 = 0, \quad \lambda_2 = 2 \operatorname{Re} \zeta_1, \quad \lambda_2 = \zeta_2 - \zeta_1, \quad \lambda_2 = \bar{\zeta}_2 - \bar{\zeta}_1,$$

and, in case 3° ,

$$(3.11) \quad \lambda_2 = 0, \quad \lambda_2 = \operatorname{Re}(\zeta_1 + \zeta_2), \quad \lambda_2 = \operatorname{Re}(\zeta_1 - \zeta_2), \quad \lambda_2 = 0.$$

Conditions for negativity of $\operatorname{Re} \lambda_2$ for $\lambda \neq 0$ in (3.10) and (3.11) yield, respectively, the conditions for stability of spinning and symmetric modes. A comparison of (3.10) and (3.11) shows that these modes cannot be stable simultaneously since the stability conditions, $\operatorname{Re} \zeta_2 < \operatorname{Re} \zeta_1$ in (3.10) and $\operatorname{Re} \zeta_2 > \operatorname{Re} \zeta_1$ in (3.11), are opposite to one another.

We go now to the example in which domain G is a square. In this case, v_1 and v_2 are given by formula (1.13) with

$$g_1 = \cos \frac{\pi m \xi_2}{l} \cos \frac{\pi k \xi_3}{l}, \quad g_2 = \cos \frac{\pi m \xi_3}{l} \cos \frac{\pi k \xi_2}{l},$$

k and m are nonnegative integers, whereby the condition for $\tilde{\sigma}$ to be of multiplicity two is reduced to the requirement that $k \neq m$ and that $k^2 + m^2$ cannot be represented as a sum of squares of two integers in another way. Without dwelling

on the form of y_2 , ω_2 , etc., we write out equations (2.13) directly. They have the form

$$(3.12) \quad \begin{aligned} \Pi_1 &\equiv -i\chi_1\rho_2 + \mu_2\dot{\lambda}\chi_1 + \chi_1|\chi_1|^2\zeta_1 + \chi_1|\chi_2|^2\zeta_2 + \bar{\chi}_1\chi_2^2\zeta_3 = 0, \\ \Pi_2 &\equiv -i\chi_2\rho_2 + \mu_2\dot{\lambda}\chi_2 + \chi_2|\chi_2|^2\zeta_1 + \chi_2|\chi_1|^2\zeta_2 + \bar{\chi}_2\chi_1^2\zeta_3 = 0, \end{aligned}$$

where ζ_1 , ζ_2 , ζ_3 can be found by differentiating Q_1 . A study of equations (3.12) has shown that we have the following solutions:

- 1a. $\chi_1 = 0$, $|\chi_2| = 1$,
- 1b. $\chi_2 = 0$, $|\chi_1| = 1$, $-i\rho_2 + \mu_2\dot{\lambda} = -\zeta_1$,
- 2a. $\chi_1 = \chi_2 = 2^{-1/2} \exp i\sigma$,
- 2b. $\chi_1 = -\chi_2 = 2^{-1/2} \exp i\sigma$, $-i\rho_2 + \mu_2\dot{\lambda} = -(\zeta_1 + \zeta_2 + \zeta_3)$,
- 2c. $\chi_1 = i\chi_2 = 2^{-1/2} i \exp i\sigma$,
- 2d. $\chi_1 = -i\chi_2 = 2^{-1/2} i \exp i\sigma$, $-i\rho_2 + \mu_2\dot{\lambda} = -(\zeta_1 + \zeta_2 + \zeta_3)$,
3. $\chi_1 = \left(\frac{k}{1+k}\right)^{1/2} e^{i\alpha}$, $\chi_2 = \left(\frac{k}{1+k}\right)^{1/2} e^{i\sigma}$,
 $k = \frac{\text{Im } \zeta_4 \pm (1 - (\text{Re } \zeta_4)^2)^{1/2}}{\text{Im } \zeta_4 \mp (1 - (\text{Re } \zeta_4)^2)^{1/2}}$,
 $\alpha = \sigma + \gamma/2 + \pi j \quad (j = 0, 1)$, $\exp i\gamma = \text{Re } \zeta_4 \pm i(1 - (\text{Re } \zeta_4)^2)^{1/2}$,
 $\zeta_4 = (\zeta_1 - \zeta_2)/\zeta_3$.

Here σ is an arbitrary real number; solutions 1 and 2 exist for arbitrary ζ_1 , ζ_2 , ζ_3 ; and solution 3 exists provided $|\zeta_4| > 1$, $|\text{Re } \zeta_4| < 1$.

A study of stability has shown that solutions 1a and 1b have identical conditions of stability, as so also 2a, 2b, 2c, and 2d, where not all of them can be stable at the same time; finally, the solutions 3 are always unstable.

As is evident from the results presented above, an elucidation of questions concerning existence, uniqueness, and stability of solutions of problem (1.9), (1.2) branching from a planar wave reduces to the solution of some algebraic problems (to the solution of equations (2.13) for determining the existence and uniqueness of a solution and for obtaining the eigenvalues of matrix \mathcal{D} to determine its stability).

Mathematical Proofs

§1. Statement of the problem and linear analysis

1.1. Statement of the problem. We consider the system of equations

$$(1.1) \quad \frac{\partial v}{\partial t} = A\Delta v + F(v, \mu).$$

Here $v = (v_1, v_2, \dots, v_p)$ is a vector-valued function, μ is a real parameter,

$$\Delta v = \sum_{i=1}^N \frac{\partial^2 v}{\partial \xi_i^2},$$

A is a square positive-definite matrix, and $F(v, \mu)$ is a vector-valued function which is assumed to be sufficiently smooth. System (1.1) is considered in a cylinder Ω : $\xi = (\xi_1, \xi')$, $-\infty < \xi_1 < +\infty$, $(\xi_2, \dots, \xi_N) \in G$, where G is a bounded domain of $(N-1)$ -dimensional space with a sufficiently smooth boundary. On boundary S of cylinder Ω there is given the boundary condition

$$(1.2) \quad \left. \frac{\partial v}{\partial \nu} \right|_S = 0$$

(ν is the normal to S).

We assume that there exists a plane wave, i.e., a solution of equation (1.1) of the form

$$v = \tilde{v}_\mu(\xi_1 - \tilde{\omega}_\mu \tau),$$

so that $\tilde{v}_\mu(x)$ is a solution of the equation

$$(1.3) \quad A\tilde{v}_\mu''(x) + \tilde{\omega}_\mu \tilde{v}_\mu'(x) + F(\tilde{v}_\mu, \mu) = 0.$$

We assume here that $\tilde{v}_\mu(x)$ is a sufficiently smooth function which, together with its first derivatives, has limits as $x \rightarrow \pm\infty$.

Our interest centers on solutions of equation (1.1) of the type of traveling waves, propagating along the cylinder axis with speed ω . Changing over to coordinates connected with the front of a wave, i.e., making the substitution $\xi_1' = \xi_1 - \omega\tau$, $\xi_k' = \xi_k$ ($k = 2, 3, \dots, N$), and returning to the previous notation ξ_1, \dots, ξ_N , we obtain, in place of (1.1), the system

$$(1.4) \quad \frac{\partial v}{\partial t} = A\Delta v + \omega \frac{\partial v}{\partial \xi_1} + F(v, \mu).$$

We note that ω is unknown and, like function v , is to be determined.

We seek solutions v of problem (1.4), (1.2), periodic with respect to the time t , that are close to a planar wave \tilde{v}_μ appearing as the result of a bifurcation with

the passage of parameter μ through some value μ_0 (for simplicity, we assume that $\mu_0 = 0$). It is convenient here to change over to a new variable $\tau = t\rho$, where ρ is a parameter, depending on μ , which is to be determined, being chosen so that in the new coordinates the solution will have period 2π . We obtain the system

$$(1.5) \quad \rho \frac{\partial v}{\partial \tau} = A\Delta v + \omega \frac{\partial v}{\partial \xi_1} + F(v, \mu).$$

1.2. Spectrum of a linearized stationary operator. We linearize the operator defined by the right-hand side of system (1.5), on the planar wave \tilde{v}_μ , where the speed ω is considered to be fixed and equal to the speed of the planar wave: $\omega = \tilde{\omega}_\mu$. We obtain the operator

$$(1.6) \quad \Lambda_\mu v = A\Delta v + \tilde{\omega}_\mu \frac{\partial v}{\partial \xi_1} + B_\mu v,$$

where $B_\mu = F'_v(\tilde{v}_\mu, \mu)$ is the matrix of the partial derivatives of $F(v, \mu)$ with respect to v_1, \dots, v_p . For definiteness, we assume that operator Λ_μ is considered in a Sobolev space $H^{2r}(\Omega)$, where r is an integer ($H^{2r}(\Omega)$ is the space of vector-valued functions defined in Ω and square-summable) together with derivatives to order $2r$. The domain of definition of operator Λ_μ is the set of functions $v \in H^{2r+2}(\Omega)$, satisfying the boundary condition (1.2).

We make certain assumptions concerning the spectrum of operator Λ_μ , which, as we show later on, are sufficient for bifurcation of waves of interest to us. It is convenient to make these assumptions in terms of an operator $L_{\sigma\mu}$, which will be introduced presently, and to then determine their significance for operator Λ_μ .

We consider the problem

$$(1.7) \quad \Delta g = -\sigma g, \quad \left. \frac{\partial g}{\partial \nu} \right|_{\partial G} = 0,$$

where Δ is the $(N - 1)$ -dimensional Laplace operator in the cylinder cross-section G . Let

$$(1.8) \quad \sigma = 0, \sigma_1, \dots, \sigma_k, \dots$$

be the eigenvalues of problem (1.7) (multiple eigenvalues are repeated), and let

$$(1.9) \quad g = 1, g_1, \dots, g_k, \dots$$

be the corresponding eigenfunctions, which form an orthonormalized system with respect to the inner product in $L^2(\Omega)$. We pass from function $v(\xi)$ to its Fourier coefficients relative to system (1.9):

$$(1.10) \quad \theta_k(\xi_1) = \int_G v(\xi_1, \xi') \bar{g}_k(\xi') d\xi',$$

and, in correspondence with this, from operator Λ_μ to operator $L_{\sigma\mu}$:

$$(1.11) \quad L_{\sigma\mu}\theta = A\theta'' - \sigma A\theta + \tilde{\omega}_\mu\theta' + B_\mu\theta,$$

which is obtained by multiplying Λ_μ by \bar{g}_k and integrating over G . In equation (1.10) the overbar denotes the complex conjugate.

We shall consider operator $L_{\sigma\mu}$ as acting in the space $H^{2r}(\mathbb{R}^1)$ with domain of definition $H^{2r+2}(\mathbb{R}^1)$.

We formulate conditions that will be imposed on the eigenvalues of operator $L_{\sigma_k\mu}$ ($k = 0, 1, \dots$). We note first that if we differentiate equation (1.3) with respect to x for $\mu = 0$, we then obtain $L_{00}\tilde{v}'_0 = 0$. We shall assume that \tilde{v}'_0 is an element of the space $H^{2r+2}(\mathbb{R}^1)$, so that operator L_{00} has a zero eigenvalue. This assumption is satisfied in many physical models. In case \tilde{v}'_0 does not belong to the space $H^{2r+2}(\mathbb{R}^1)$, the discussion is simplified.

CONDITION 1. The point $\lambda = 0$ is a simple eigenvalue of operator L_{00} and it is not an eigenvalue of operators L_{σ_k0} for $k > 0$.

CONDITION 2. Let γ be the imaginary axis of the λ -plane with the point 0 deleted. We can then find one and only one σ_k for which there are eigenvalues of operator L_{σ_k0} on γ . Let us denote this σ_k by $\tilde{\sigma}$. Operator $L_{\tilde{\sigma}0}$ has exactly two eigenvalues on γ and they are simple.

Let $\pm i\kappa$, $\kappa > 0$, be the eigenvalues of operator $L_{\tilde{\sigma}0}$, and let λ_μ be an eigenvalue of operator $L_{\tilde{\sigma}\mu}$ such that $\lambda_0 = i\kappa$, i.e., λ_μ is a continuation of the eigenvalue $i\kappa$ with respect to μ . In view of the assumed simplicity of the eigenvalue $i\kappa$, such a continuation exists. Moreover, in view of the smoothness of functions $F(v, \mu)$ and \tilde{v}_μ , it is easy to see that the derivative of λ_μ with respect to μ exists.

CONDITION 3.

$$(1.12) \quad \operatorname{Re} \left. \frac{d\lambda_\mu}{d\mu} \right|_{\mu=0} \neq 0.$$

Since Λ_μ is an elliptic operator, considered in an unbounded cylinder, it then has not only a discrete but also a continuous spectrum. We impose restrictions on the coefficients of operator Λ_μ , guaranteeing that its continuous spectrum lies in the left half of the λ -plane. In particular, we let

$$B_\mu^\pm = \lim_{\xi_1 \rightarrow \pm\infty} B_\mu(\xi_1).$$

CONDITION 4. All eigenvalues of the matrices $B_0^\pm - A\rho$ for all $\rho \geq 0$ lie in the left half of the λ -plane.

Based on the results of Chapter 4, we can prove the following proposition.

PROPOSITION 1.1. *When Condition 4 is satisfied, the continuous spectrum of operator Λ_μ , as well as that of operator $L_{\sigma\mu}$, $\sigma \geq 0$, for μ sufficiently close to zero, lies in the angle*

$$\operatorname{Re} \lambda + \alpha |\operatorname{Im} \lambda| + b \leq 0 \quad (\alpha > 0, \quad b > 0).$$

Henceforth we shall assume that Conditions 1–4 are satisfied.

PROPOSITION 1.2. *The spectrum of operator Λ_0 intersects the imaginary axis of the λ -plane at three points: $\lambda = 0$, $\lambda = \pm i\kappa$, these being eigenvalues; here, $\lambda = 0$ is a simple eigenvalue, while $\lambda = \pm i\kappa$ are eigenvalues of multiplicity n , where n is the multiplicity of the eigenvalue $\sigma = \tilde{\sigma}$ of problem (1.7).*

PROPOSITION 1.3. *The eigenvalue $i\kappa$ has a unique smooth extension λ_μ ($\lambda_0 = i\kappa$), as an eigenvalue of operator Λ_μ , and we have for it the relation (1.12).*

We prove this proposition and, in passing, obtain the form of the eigenfunctions of operator Λ_μ corresponding to the indicated eigenvalues. These eigenfunctions will be required later on.

We show first that $\lambda = 0$ is a simple eigenvalue of operator Λ_0 . Let $\varphi_0(\xi_1)$ be the eigenfunction of operator L_{00} corresponding to the zero eigenvalue. Obviously,

$$(1.13) \quad \Lambda_0 \varphi_0 = 0.$$

We show that the equation

$$(1.14) \quad \Lambda_0 v = 0$$

has no other linearly independent solutions. Indeed, if $v(\xi)$ is a solution of (1.14), then θ_k , given by the equation (1.10), is a solution of the equation

$$L_{\sigma_k 0} \theta_k = 0.$$

It follows from Condition 1 that $\theta_0 = \chi \varphi_0$, where χ is a constant and $\theta_k = 0$ for $k > 0$. Expanding $v(\xi)$ in a Fourier series according to system (1.9), we obtain

$$v(\xi) = \chi \varphi_0(\xi_1).$$

Thus we have shown that the space of solutions of equation (1.14) is one-dimensional.

We introduce the operators

$$\begin{aligned} L_{\sigma\mu}^* \psi &= A\psi'' - \sigma A\psi - \tilde{\omega}_\mu \psi' + B_\mu^* \psi, \\ \Lambda_\mu^* \varphi &= A\Delta\varphi - \tilde{\omega}_\mu \frac{\partial\varphi}{\partial\xi_1} + B_\mu^* \varphi, \end{aligned}$$

where B_μ^* is the matrix adjoint to B_μ . We shall consider operator $L_{\sigma\mu}^*$ as acting in $H^{2r}(\mathbb{R}^1)$ with domain of definition $H^{2r+2}(\mathbb{R}^1)$, and operator Λ_μ^* as acting in $H^{2r}(\Omega)$ with the domain of definition being the set of vector-valued functions $\varphi \in H^{2r+2}(\Omega)$ satisfying the condition

$$\left. \frac{\partial\varphi}{\partial\nu} \right|_S = 0.$$

By Condition 1 the equation

$$(1.15) \quad L_{00}^* \psi = 0$$

has a one-dimensional space of solutions. Let $\psi = \psi_0$ be a nonzero solution of equation (1.15). Obviously,

$$(1.16) \quad \Lambda_0^* \psi_0 = 0.$$

Since the zero eigenvalue of operator L_{00} is simple, we have

$$(1.17) \quad \{\varphi_0, \psi_0\} \neq 0.$$

Here, and in what follows, we use the notation

$$\{v, \varphi\} = \int_{-\infty}^{\infty} (v, \varphi) d\xi_1$$

for arbitrary vector-valued functions, $v, \varphi \in L^2(\mathbb{R}^1)$, where (\cdot, \cdot) is the scalar product in \mathbb{R}^p . We shall also write

$$[v, \varphi] = \int_{\Omega} (v, \varphi) d\xi$$

for arbitrary vector-valued functions $v, \varphi \in L^2(\Omega)$. It obviously follows from (1.17) that

$$(1.18) \quad [\varphi_0, \psi_0] \neq 0.$$

Noting, on the basis of Proposition 1.1, that operator Λ_0 possesses the Fredholm property, we conclude from (1.18) that zero is a simple eigenvalue of operator Λ_0 .

We show now that $\lambda = i\mathcal{N}$ is an eigenvalue of operator Λ_0 . We denote by

$$g_k(\xi') \quad (k = 1, 2, \dots, n)$$

all those eigenfunctions (1.9) that correspond to the eigenvalue $\sigma = \tilde{\sigma}$ of problem (1.7). Further, let $\theta(\xi_1)$ be the eigenfunction of operator $L_{\tilde{\sigma}0}$ corresponding to the eigenvalue $i\mathcal{N}$:

$$(1.19) \quad L_{\tilde{\sigma}0}\theta = i\mathcal{N}\theta.$$

We may then verify directly the equality

$$(1.20) \quad \Lambda_0 v^k = i\mathcal{N}v^k \quad (k = 1, 2, \dots, n),$$

where

$$(1.21) \quad v^k(\xi) = \theta(\xi_1)g_k(\xi') \quad (k = 1, 2, \dots, n).$$

Since operator $\Lambda_0 - i\mathcal{N}I$ (I is the unit operator) possesses the Fredholm property (by virtue of Proposition 1.1), it then follows from (1.20) that $i\mathcal{N}$ is an eigenvalue of operator Λ_0 .

We show that the functions (1.21) form a complete system of eigenfunctions of operator Λ_0 corresponding to the eigenvalue $i\mathcal{N}$. Indeed, if

$$(1.22) \quad \Lambda_0 v = i\mathcal{N}v,$$

the function θ_k given by equation (1.10) is a solution of the equation

$$L_{\sigma_k 0}\theta_k = i\mathcal{N}\theta_k$$

and, therefore, is different from zero only when $\sigma_k = \tilde{\sigma}$. Consequently, the expansion of $v(\xi)$ in a Fourier series with respect to the functions (1.9) gives

$$v(\xi) = \sum_{k=1}^n \chi_k(\xi_1)g_k(\xi'),$$

where

$$\chi_k(\xi_1) = \int_G v(\xi)\overline{g_k(\xi')} d\xi'.$$

Obviously, by virtue of (1.22), $\chi_k(\xi)$ is a solution of equation (1.19) and, owing to the fact that $i\mathcal{N}$ is a simple eigenvalue of operator $L_{\tilde{\sigma}0}$, we find that

$$\chi_k(\xi_1) = \alpha_k\theta(\xi_1),$$

where α_k is a constant. Thus we have shown that an arbitrary solution of equation (1.22) is a linear combination of the functions (1.21).

Consider now the equation

$$(1.23) \quad \Lambda_0^* \varphi = -i\mathcal{N}\varphi.$$

Let ψ be the eigenfunction of operator $L_{\bar{\sigma}0}^*$, corresponding to the eigenvalue $-i\mathcal{N}$:

$$(1.24) \quad L_{\bar{\sigma}0}^* \psi = -i\mathcal{N}\psi.$$

Reasoning as we did above, we find that the complete system of linearly independent solutions of equation (1.23) has the form

$$(1.25) \quad \varphi^k = \psi(\xi_1)g_k(\xi') \quad (k = 1, 2, \dots, n).$$

Obviously,

$$[v^m, \varphi^k] = \{\theta, \psi\}\delta_{mk} \quad (k, m = 1, 2, \dots, n).$$

Owing to the fact that $i\mathcal{N}$ is a simple eigenvalue of operator $L_{\bar{\sigma}0}$, the functions θ and ψ can be considered to be chosen so that

$$\{\theta, \psi\} = 1.$$

Therefore,

$$(1.26) \quad [v^m, \varphi^k] = \delta_{mk} \quad (k, m = 1, 2, \dots, n).$$

It follows from (1.26) that operator Λ_0 has no associated functions. Thus we have shown that $i\mathcal{N}$ is an eigenvalue of operator Λ_0 of multiplicity n . This establishes Proposition 1.2.

We prove Proposition 1.3. Let λ_μ be an eigenvalue of operator $L_{\bar{\sigma}\mu}$, as discussed in Condition 3. Assume, further, that θ_μ is the corresponding eigenfunction, which is continuous with respect to μ and such that $\theta_0 = \theta$,

$$(1.27) \quad L_{\bar{\sigma}\mu}\theta_\mu = \lambda_\mu\theta_\mu.$$

Multiplying (1.27) by g_k , we obtain

$$(1.28) \quad \Lambda_\mu v_\mu^k = \lambda_\mu v_\mu^k \quad (k = 1, 2, \dots, n),$$

where

$$v_\mu^k(\xi) = \theta_\mu(\xi_1)g_k(\xi') \quad (k = 1, 2, \dots, n).$$

Thus λ_k is an eigenvalue of operator Λ_μ .

Let V be a neighborhood of point $i\mathcal{N}$ in the λ -plane such that operator $L_{\bar{\sigma}\mu}$ for $|\mu| < \delta$ has no eigenvalues in V different from λ_μ . Decreasing, if necessary, the neighborhood V and the number δ , we can assure ourselves that when $|\mu| < \delta$ and $\sigma_k \neq \bar{\sigma}$ the operator $L_{\sigma_k\mu}$ will have only regular points in V . This follows from the fact that operator L_{σ_k0} ($\sigma \neq \bar{\sigma}$) has no points of its spectrum on γ and that, for σ sufficiently large and $|\mu| < \delta$, the entire spectrum of operator $L_{\sigma\mu}$ lies in the half-plane $\operatorname{Re} \lambda < -K$ ($K > 0$) (see Chapter 4). We show now, for $|\mu| < \delta$, that

in the indicated neighborhood V of point $i\lambda$ the operator Λ_μ has no eigenvalues different from the eigenvalue λ_μ of operator $L_{\tilde{\sigma}\mu}$. Indeed, let

$$(1.29) \quad \Lambda_\mu v_\mu = \widehat{\lambda}_\mu v_\mu \quad (\widehat{\lambda} \in V, \quad |\mu| < \delta, \quad v_\mu \neq 0).$$

Further, let

$$\theta_{\mu k}(\xi_1) = \int_G v_\mu(\xi) \overline{g_k(\xi')} d\xi'.$$

Then from (1.29) it follows that

$$(1.30) \quad L_{\sigma_k \mu} \theta_{\mu k} = \widehat{\lambda}_\mu \theta_{\mu k}.$$

By the aforesaid, $\theta_{\mu k} = 0$ for $\sigma_k \neq \tilde{\sigma}$, and, therefore, $\theta_{\mu k} \neq 0$ for at least one k such that $\sigma_k = \tilde{\sigma}$. From (1.30) we find that $\widehat{\lambda}_\mu$ is an eigenvalue of operator $L_{\tilde{\sigma}\mu}$; consequently, $\widehat{\lambda}_\mu = \lambda_\mu$. This establishes Proposition 1.3.

REMARK. By virtue of Proposition 1.2, as μ passes through zero, two of the eigenvalues of operator Λ_μ cross over into the right half-plane. A more general case could be considered in which a larger number of eigenvalues cross over; however, we shall not concern ourselves with this here. We limit the discussion to the simplest assumptions that lead to the effects described in the Introduction. On the other hand, greater simplification of the assumptions might lead to the exclusion of physically interesting phenomena. Indeed, we cannot avoid considering the zero eigenvalue, since the derivative $\tilde{v}'_\mu(\xi_1)$ is an eigenfunction corresponding to the zero eigenvalue of operator Λ_μ . Further, the multiplicity requirement for the eigenvalue $i\lambda$ of operator Λ_0 is connected with the multiplicity of the eigenvalue σ of problem (1.7), and already in the simplest, and very important for applications, case of a circular cylinder this multiplicity can be equal to two.

1.3. Linearized nonstationary problem. Linearization of the nonstationary system (1.5) on the plane wave \tilde{v}_0 with $\mu = 0$ leads to the operator

$$Lv = A\Delta v - \rho_0 \frac{\partial v}{\partial \tau} + \tilde{\omega}_0 \frac{\partial v}{\partial \xi_1} + B_0 v,$$

where ρ_0 denotes the value of ρ for $\mu = 0$. We shall regard the operator as acting in the space $H^{2r,r}$. Here $H^{2r,r}$ is the closure of the set of unbounded differentiable vector-valued functions $v(\xi, \tau)$, given in a neighborhood of the set $Q = \Omega \times [0, 2\pi]$, periodic in τ with period 2π and vanishing for large $|\xi|$, with respect to the norm

$$\left[\sum_{0 \leq |\alpha| + 2\beta \leq 2r} \int_Q |\mathcal{D}_\xi^\alpha \mathcal{D}_\tau^\beta v(\xi, \tau)|^2 d\xi d\tau \right]^{1/2},$$

$$\alpha = (\alpha_1, \dots, \alpha_N), \quad |\alpha| = \alpha_1 + \dots + \alpha_N.$$

The domain of definition of operator L consists of vector-valued functions v , belonging to the space $H^{2r+2,r+1}$ and satisfying condition (1.2).

We consider the equation

$$(1.31) \quad Lv = 0$$

and find all of its solutions. We note that ρ_0 , like v , is unknown. We assume that $\rho_0 \neq 0$.

It may be verified directly that as solutions of equation (1.31) we have

$$(1.32) \quad \begin{cases} \rho_0 \text{ -arbitrary,} & v_0 = \varphi_0/(2\pi)^{1/2}, \\ \rho_0 = \varkappa, & v_k(\xi, \tau) = \theta(\xi_1)g_k(\xi') \exp(i\tau)/(2\pi)^{1/2}, \\ \bar{v}_k(\xi, \tau) = \bar{\theta}(\xi_1)g_k(\xi') \exp(-i\tau)/(2\pi)^{1/2} & (k = 1, 2, \dots, n) \end{cases}$$

(the bar indicates the complex conjugate).

Actually, as solutions we also have

$$(1.33) \quad \begin{cases} \rho_0 = \varkappa/m, & v_k(\xi, \tau) = \theta(\xi_1)g_k(\xi') \exp(im\tau)/(2\pi)^{1/2}, \\ \bar{v}_k(\xi, \tau) = \bar{\theta}(\xi_1)g_k(\xi') \exp(-im\tau)/(2\pi)^{1/2} & (k = 1, 2, \dots, n) \end{cases}$$

for all integral $m \neq 0$. However, we can limit ourselves to the solutions (1.32) since if we return to the initial variable we then find that $m\tau = \varkappa t$ for all m .

We show that equation (1.31) has no other linearly independent solutions, except for those indicated.

We assume, at first, that solution v of equation (1.31) does not depend on τ . Then, obviously, $\Lambda_0 v = 0$ and, on the basis of Condition 1,

$$v = \chi_0 \tilde{v}'_0.$$

Assume now that $v(\xi, \tau)$ depends essentially on τ , i.e., $\partial v(\xi, \tau)/\partial \tau$ is not identically zero. Let

$$(1.34) \quad \tilde{v}(\xi) = \int_0^{2\pi} v(\xi, \tau) \exp(ik\tau) d\tau,$$

where k is an integer. We multiply (3.2) by $\exp(ik\tau)$ and integrate with respect to τ . We obtain

$$(1.35) \quad \Lambda_0 \tilde{v} = ik\rho_0 \tilde{v}.$$

Since v depends essentially on τ , it follows that there exists a $k \neq 0$ such that $\tilde{v} \neq 0$. From (1.35), based on Condition 1, we now have

$$\rho_0 = \pm \varkappa/k.$$

Thus we have found the form of ρ_0 . Suppose ρ_0 has the form (1.33). Then for the functions $\tilde{v}(\xi)$, given by equation (1.34), it follows, on the basis of (1.35), that $\tilde{v}(\xi) = 0$ for $k \neq 0, \pm m$. Consequently, $v(\xi, \tau)$ is a linear combination of \tilde{v}'_0 and functions v_k and \bar{v}_k given by equation (1.33).

In what follows we assume that

$$\rho_0 = \varkappa.$$

Consider the equation adjoint to (1.31):

$$(1.36) \quad L^* \varphi = 0,$$

where

$$L^* \varphi = A\Delta\varphi + \rho_0 \frac{\partial \varphi}{\partial \tau} - \tilde{\omega}_0 \frac{\partial \varphi}{\partial \xi_1} + B_0^* \varphi.$$

We assume that operator L^* has the same domain of definition as L .

As was the case above, it may be proved that all the linearly independent solutions of equation (1.36) have the form

$$(1.37) \quad \begin{cases} \varphi_0(\xi, \tau) = \psi_0(\xi_1)/(2\pi)^{1/2}, & \varphi_k(\xi, \tau) = \psi(\xi_1)g_k(\xi') \exp(i\tau)/(2\pi)^{1/2}, \\ \overline{\varphi}_k(\xi, \tau) = \overline{\psi(\xi_1)g_k(\xi')} \exp(-i\tau)/(2\pi)^{1/2} & (k = 1, 2, \dots, n), \end{cases}$$

where ψ_0 and ψ are solutions of equations (1.16) and (1.24), respectively.

We introduce the inner product

$$\langle v, \varphi \rangle = \int_0^{2\pi} d\tau \int_{\Omega} (v(\xi, \tau), \varphi(\xi, \tau)) d\xi$$

for vector-valued functions belonging to $L^2(\Omega \times [0, 2\pi])$. We shall also assume that $\varphi_0 = \tilde{v}'_0(2\pi)^{1/2}$ and function ψ_0 is normalized so that

$$[\varphi_0, \psi_0] = 1,$$

which is possible by virtue of (1.18). Then, noting (1.26), it is readily verified that

$$(1.38) \quad \begin{aligned} \langle v_m, \varphi_k \rangle &= \delta_{mk} & (k, m = 0, 1, \dots, n), \\ \langle v_m, \overline{\varphi}_k \rangle &= 0 & (k, m = 0, 1, \dots, n). \end{aligned}$$

PROPOSITION 1.4. *For solvability of the equation*

$$(1.39) \quad Lv = f \quad (f \in H^{2r,r})$$

it is necessary and sufficient that the following conditions be satisfied:

$$\begin{aligned} \langle f, \varphi_k \rangle &= 0 & (k = 0, 1, \dots, n), \\ \langle f, \overline{\varphi}_k \rangle &= 0 & (k = 0, 1, \dots, n). \end{aligned}$$

PROOF. The necessity part of the proof is obvious. We prove the sufficiency. Let

$$(1.40) \quad f_k(\xi) = \frac{1}{2\pi} \int_0^{2\pi} f(\xi, \tau) \exp(-ik\tau) d\tau \quad (k = 0, \pm 1, \dots),$$

and consider the equation

$$(1.41) \quad \Lambda_0 v_k - ik\rho_0 v_k = f_k \quad (k = 0, \pm 1, \dots).$$

Obviously, $f_k \in H^{2r}(\Omega)$. We show that equation (1.41) is solvable. By virtue of Proposition 1.2, for $|k| > 1$ the numbers $ik\rho_0$ are regular points of operator Λ_0 , and, therefore, for these values of k equation (1.41) is solvable. Further, it may be verified directly that

$$(1.42) \quad \begin{aligned} [f_0, \varphi_0] &= \langle f, \varphi_0 \rangle / (2\pi) = 0, \\ [f_1, \varphi^k] &= \langle f, \varphi_k \rangle / (2\pi)^{1/2} = 0 & (k = 1, \dots, n), \\ [f_{-1}, \overline{\varphi}^k] &= \langle f, \overline{\varphi}_0 \rangle / (2\pi)^{1/2} = 0, \end{aligned}$$

where φ^k are functions given by equation (1.25). It follows from the results of §1.2 that functions φ_0, φ^k , and $\overline{\varphi}^k$ ($k = 1, \dots, n$) form a complete system of linearly independent solutions of equation

$$\Lambda_0^* \varphi + ik\rho_0 \varphi = 0$$

for k equal to 0, 1, and -1 , respectively, and that the conditions (1.42) are sufficient

for solvability of equation (1.41) for $k = 0, \pm 1$. Thus, we have established the solvability of equation (1.41) for all k .

To prove solvability of equation (1.39) we construct a solution in the form of Fourier series; a proof of the convergence of this series, in the norms in question, requires estimates of solutions of equations (1.41). We make use of estimates obtained in Chapter 4 for equations with a parameter. Satisfaction of the conditions required to validate these estimates may easily be verified. Here, in particular, we use Condition 4. In connection with system (1.41) (k plays the role of a parameter), these estimates have the form

$$(1.43) \quad \|v_k\|_{2r+2}^2 + k^{2r+2}\|v_k\|_0^2 \leq K_0[\|f_k\|_{2r}^2 + k^{2r}\|f_k\|_0^2],$$

where $\|\cdot\|_m$ is the norm in the space $H^m(\Omega)$; constant K_0 does not depend on k , and $|k| > \widehat{k}$, where \widehat{k} is some number.

From (1.40) it follows that

$$f_k(\xi) = \frac{1}{2\pi(ki)^r} \int_0^{2\pi} \frac{\partial^r f(\xi, \tau)}{\partial \tau^r} \exp(-ik\tau) d\tau,$$

$$\mathcal{D}_\xi^\alpha f_k(\xi) = \frac{1}{2\pi} \int_0^{2\pi} \mathcal{D}_\xi^\alpha f(\xi, \tau) \exp(-ik\tau) d\tau \quad (|\alpha| \leq 2r).$$

Applying Parseval's equality, integrating over Ω , and adding, we obtain

$$(1.44) \quad \sum_{k=-\infty}^{\infty} [\|f_k\|_{2r}^2 + k^{2r}\|f_k\|_0^2] \leq K_1\|f\|_{H^{2r,r}}^2,$$

where K_1 is a constant.

Consider the series

$$(1.45) \quad \sum_{k=-\infty}^{\infty} v_k(\xi) \exp(ik\tau).$$

We show that it converges in the $H^{2r+2,r+1}$ -norm. For positive integers p and q (and similarly, for negative integers p and q) we have

$$\begin{aligned} & \left\| \sum_{k=p}^{p+q} v_k(\xi) \exp(ik\tau) \right\|_{H^{2r+2,r+1}}^2 \\ &= \sum_{|\alpha|+2\beta \leq 2r+2} \int_0^{2\pi} d\tau \int_\Omega \left| \mathcal{D}_\xi^\alpha \mathcal{D}_\tau^\beta \sum_{k=p}^{p+q} v_k(\xi) \exp(ik\tau) \right|^2 d\xi \\ &= 2\pi \sum_{|\alpha|+2\beta \leq 2r+2} \int_\Omega \sum_{k=r}^{p+q} |\mathcal{D}_\xi^\alpha v_k(\xi)|^2 |k|^{2\beta} d\xi \\ &\leq 2\pi \sum_{k=p}^{p+q} \sum_{\beta=0}^{r+1} |k|^{2\beta} \|v_k\|_{2r+2-2\beta}^2 \leq K_2 \sum_{k=p}^{p+q} [\|v_k\|_{2r+2}^2 + |k|^{2r+2}\|v_k\|_0^2], \end{aligned}$$

where K_2 does not depend on k . We have applied an interpolational inequality (see Chapter 4). Noting (1.43) and (1.44), we find that the right-hand side of the last inequality tends towards zero as $p, q \rightarrow +\infty$. Thus, we have shown that series (1.45) converges in the $H^{2r,2}$ -norm. Its sum belongs to the domain of definition of operator

L and is a solution of equation (1.39). This completes the proof of the proposition. \square

In what follows, we shall require estimates of solutions of equation (1.39), more precisely, of a more general equation. Namely, we consider the operator

$$(1.46) \quad L^\rho v = A\Delta v - \rho \frac{\partial v}{\partial \tau} + \tilde{\omega}_0 \frac{\partial v}{\partial \xi} + B_0 v,$$

acting in $H^{2r,r}$, the domain of definition for which is the set of vector-valued functions v belonging to $H^{2r+2,r+1}$ and satisfying condition (1.2) (so that when $\rho = \rho_0$ this operator coincides with L). We shall assume that

$$\varkappa/2 + \varepsilon < \rho < M,$$

where ε and M are given positive constants ($\varepsilon < \varkappa/2$).

PROPOSITION 1.5. *For existence of a solution of equation*

$$(1.47) \quad L^\rho v = f \quad (f \in H^{2r,r}),$$

satisfying the conditions

$$(1.48) \quad \langle v, \varphi_k \rangle = 0, \quad \langle v, \bar{\varphi}_k \rangle = 0 \quad (k = 0, 1, \dots, n),$$

it is necessary and sufficient that the following conditions are satisfied:

$$(1.49) \quad \langle f, \varphi_k \rangle = 0, \quad \langle f, \bar{\varphi}_k \rangle = 0 \quad (k = 0, 1, \dots, n).$$

When conditions (1.48) are satisfied, the solution of equation (1.47) is unique, and we have the estimate

$$(1.50) \quad \|v\|_{H^{2r+2,r+1}} \leq K \|f\|_{H^{2r,r}},$$

where constant K is independent of f and ρ .

PROOF. We first prove the necessity for condition (1.49). Let v be a solution of equation (1.47) satisfying conditions (1.48). We have

$$(1.51) \quad \langle L^\rho v, \varphi_k \rangle = (\rho - \rho_0) \langle v, \partial \varphi_k / \partial \tau \rangle.$$

But $\partial \varphi_k / \partial \tau = 0$ for $k = 0$ and $\partial \varphi_k / \partial \tau = i\varphi_k$ for $k > 0$. In both cases the right-hand side of (1.51) is equal to zero. Similarly for $\bar{\varphi}_k$. Hence necessity is proved for $\rho \neq \rho_0$. For $\rho = \rho_0$ it follows from Proposition 1.4.

We show now that the condition (1.49) is sufficient. We note that if satisfaction of conditions (1.48) is not required, existence of solutions is then proved as in Proposition 1.4 (when $\rho = \rho_0$ this coincides with Proposition 1.4). It is therefore necessary to show that among the solutions there is one which satisfies conditions (1.48). If $\rho = \rho_0$, the solution is then determined to within a term which is a linear combination of the functions v_0, v_k, \bar{v}_k ($k = 1, \dots, n$), and this term can be determined so that condition (1.48) is satisfied. When $\rho \neq \rho_0$, the solution is determined to within the term χv_0 , and the constant χ can be determined so that the solution is orthogonal to φ_0 . When $k \neq 0$, equations (1.48) follow from (1.51), since the left-hand side of this equation is equal to zero.

When condition (1.48) is satisfied, uniqueness of the solution is obvious.

We proceed now to the proof of estimate (1.50). To do this, we consider the space $H_0^{2m,m}$, which consists of the set of all $v \in H^{2m,m}$ satisfying condition (1.48).

We define operator L_0^ρ , as acting on functions $v \in H_0^{2r+2, r+2}$ with values in $H^{2r, r}$, satisfying condition (1.2) and coinciding on its domain of definition with L^ρ . Operator L_0^ρ has an inverse defined on the whole space $H^{2r, r}$. According to a theorem of Banach, operator $(L_0^\rho)^{-1}$ is bounded. Further, recalling the proof of Proposition 1.4, it is easy to show that a solution of equation (1.47), satisfying conditions (1.48), is continuous with respect to ρ in the norm of the space $H^{2r+2, r+1}$. Consequently, function $\|(L_0^\rho)^{-1}f\|$ is bounded with respect to ρ on the interval $[\varepsilon + \varkappa/2, M]$ for each $f \in H_0^{2r, r}$. By the theorem on uniform boundedness, $\|(L_0^\rho)^{-1}\|$ is bounded for all ρ . Estimate (1.50) follows from this. This completes the proof of the proposition. \square

In what follows, we need operator T , defined on functions $v \in H^{2r+2, r+1}$ by the equation

$$(1.52) \quad Tv = \tilde{\omega}_0 \frac{\partial v}{\partial \xi_1} + \dot{B}_0 v,$$

where we have introduced the notation

$$\tilde{\omega}_0 = \left. \frac{d\tilde{\omega}_\mu}{d\mu} \right|_{\mu=0}, \quad \dot{B}_0 = \left. \frac{dB_\mu}{d\mu} \right|_{\mu=0}.$$

We show that we have the equalities

$$(1.53) \quad \langle Tv_k, \varphi_m \rangle = \dot{\lambda}_0 \delta_{mk}, \quad \langle Tv_k, \bar{\varphi}_m \rangle = 0 \quad (k, m = 1, \dots, n),$$

where

$$\dot{\lambda}_0 = \left. \frac{d\lambda_\mu}{d\mu} \right|_{\mu=0},$$

λ_μ is the eigenvalue of operator Λ_μ , discussed in Proposition 1.3.

To prove equation (1.53), we differentiate (1.28) with respect to μ for $\mu = 0$. We obtain

$$(1.54) \quad \Lambda_0 \dot{v}_0^k + Tv_0^k = i\varkappa \dot{v}_0^k + \dot{\lambda}_0 v_0^k \quad (k = 1, \dots, n),$$

where

$$\dot{v}_0 = \left. \frac{dv_\mu^k}{d\mu} \right|_{\mu=0}.$$

On the basis of (1.32), we have

$$v_k(\xi, \tau) = v_0^k(\xi) \exp(i\tau)/(2\pi)^{1/2} \quad (k = 1, \dots, n).$$

Therefore, multiplying (1.54) by $\exp(i\tau)/(2\pi)^{1/2}$ and letting

$$w_k = \dot{v}_0^k(\xi) \exp(i\tau)/(2\pi)^{1/2},$$

we obtain

$$Lw_k + Tv_k = \dot{\lambda}_0 v_k \quad (k = 1, \dots, n),$$

from which (1.53) follows by virtue of (1.38).

§2. General representation of solutions of the nonlinear problem. Existence of solutions

2.1. General representation of solutions of the nonlinear problem.

We consider the nonlinear problem (1.5), (1.2) and we obtain a general representation of all of its solutions, 2π -periodic with respect to τ , branching off a planar wave, for small μ . To shorten the writing, we denote the norm in the space $H^{2r+2,r+1}$ by $\| \cdot \|$. We assume that r is chosen so large that the space $H^{2r+2,r+1}$ is embedded in the space of twice continuously differentiable functions; such r exists by imbedding theorems.

Let us first attach a precise meaning to the words “solution branching off a planar wave”. We assume that $\mu \in \Delta$, where Δ is either the interval $[0, \delta]$ or the interval $[-\delta, 0]$ for $\delta > 0$.

DEFINITION 2.1. Let us assume, for all $\mu \in \Delta$, that there exists a function $v_\mu(\xi, \tau)$, satisfying the following conditions:

1°. The function

$$(2.1) \quad w_\mu(\xi, \tau) = v_\mu(\xi, \tau) - \tilde{v}_\mu(\xi_1)$$

belongs to the space $H^{2r+2,r+1}$, is continuous with respect to μ in the norm of this space, and

$$(2.2) \quad w_0(\xi, \tau) = 0.$$

2°. For $\mu \neq 0$, $v_\mu(\xi, \tau)$ does not coincide with $\tilde{v}_\mu(\xi + h)$ for any real h .

3°. $v_\mu(\xi, \tau)$ is a solution of equation (1.5), satisfying the condition (1.2).

When conditions 1°–3° are satisfied, we say that the solution $v_\mu(\xi, \tau)$ branches off a planar wave.

Recall that if $\tilde{v}_\mu(\xi_1)$ is a planar wave, then $\tilde{v}_\mu(\xi_1 + h)$ is also a planar wave. Therefore the meaning of condition 2° is that we exclude apparent branching of the form

$$v_\mu(\xi, \tau) = \tilde{v}_\mu(\xi_1 + h(\mu)).$$

On the other hand, we can make use of the invariance of a planar wave with respect to translations in order to simplify further discussion. In particular, we have the following proposition.

PROPOSITION 2.1. For sufficiently small δ we can choose a continuous function $h(\mu)$ ($\mu \in \Delta$), such that $h(0) = 0$, and such that with the replacement of $\tilde{v}_\mu(\xi_1)$ in (2.1) by $\tilde{v}_\mu(\xi_1 + h(\mu))$ we obtain

$$(2.3) \quad \langle w_\mu, \varphi_0 \rangle = 0.$$

PROOF. We are required to prove solvability of the equation

$$(2.4) \quad \langle \tilde{v}_\mu(\xi_1 + h), \varphi_0 \rangle = \langle v_\mu, \varphi_0 \rangle$$

with respect to h . Based on (2.2), for $\mu = 0$ the solution of this equation is $h = 0$. Further,

$$\frac{\partial}{\partial h} \langle \tilde{v}_\mu(\xi_1 + h), \varphi_0 \rangle \Big|_{\mu=0, h=0} = \left\langle \frac{d\tilde{v}_0(\xi_1)}{d\xi_1}, \varphi_0 \right\rangle \neq 0$$

by virtue of Condition 1, since $d\tilde{v}_0(\xi_1)/d\xi_1$ is an eigenfunction of operator L_{00} , corresponding to the zero eigenvalue. Thus, according to the implicit function

theorem, there exists a solution of equation (2.4). The proposition is thereby established. \square

By virtue of this proposition, we can assume, without loss of generality, that (2.3) is valid.

All functions appearing in the discussion below, except for functions v_k and φ_k (see (1.32) and (1.37)), are assumed to be real. We set

$$(2.5) \quad w_\mu = \overset{1}{w} + \overset{2}{w},$$

where

$$(2.6) \quad L\overset{1}{w} = 0,$$

$$(2.7) \quad \langle \overset{2}{w}, \varphi_k \rangle = 0 \quad (k = 0, 1, \dots, n).$$

Obviously, we can represent an arbitrary function from $H^{2r+2, r+1}$ in the form (2.5). By virtue of (2.3) and (2.7), $\langle \overset{1}{w}, \varphi_0 \rangle = 0$, and, therefore,

$$(2.8) \quad \overset{1}{w} = \operatorname{Re} \sum_{k=1}^n \alpha_k v_k,$$

where α_k are complex constants. By (1.38) we have $\alpha_k = \langle w_\mu, \varphi_k \rangle$, and, therefore, setting

$$\alpha = (|\alpha_1|^2 + \dots + |\alpha_l|^2)^{1/2},$$

we obtain

$$(2.9) \quad \alpha \leq C \|w_\mu\|, \quad \|\overset{2}{w}\| \leq C \|w_\mu\|.$$

Here, and in what follows, C denotes various constants.

We introduce the notation

$$\overset{1}{\rho} = \rho - \rho_0, \quad \overset{1}{\omega} = \omega - \tilde{\omega}_\mu,$$

and we substitute ρ and ω , and also

$$v = \tilde{v}_\mu + \overset{1}{w} + \overset{2}{w}$$

into equation (1.5). If we take into account that \tilde{v}_μ and $\tilde{\omega}_\mu$ satisfy equation (1.3) and that $\overset{1}{w}$ satisfies equation (2.6), we obtain

$$(2.10) \quad L^\rho \overset{2}{w} + \overset{1}{\omega} \tilde{v}'_\mu + \mu T \overset{1}{w} - \overset{1}{\rho} \frac{\partial \overset{1}{w}}{\partial \tau} + \Phi = 0.$$

Here L^ρ is the operator (1.46), T is the operator (1.52), and

$$(2.11) \quad \begin{aligned} \Phi = & \overset{1}{\omega}_\mu \tilde{v}'_\mu + \mu^2 \tilde{\omega}_0 \frac{\partial \overset{1}{w}}{\partial \xi_1} + \overset{1}{\omega} \frac{\partial \overset{1}{w}}{\partial \xi_1} + \mu \tilde{\omega}_0 \frac{\partial \overset{2}{w}}{\partial \xi_1} + \overset{1}{\omega} \frac{\partial \overset{2}{w}}{\partial \xi_1} \\ & + \mu \dot{B}_0 \overset{2}{w} + a_2(\overset{1}{w} + \overset{2}{w}) + a_3(\overset{1}{w} + \overset{2}{w}) + \dots, \end{aligned}$$

where dotted terms replace terms whose explicit form is not essential for further

estimates; dots above functions of μ indicate derivatives with respect to μ ; a_2 and a_3 are obtained by expanding function $F(v, \mu)$ in a Taylor series,

$$F(\tilde{v}_\mu + \vartheta, \mu) = F(\tilde{v}_\mu, \mu) + B_0\vartheta + \mu\dot{B}_0\vartheta + a_2(\vartheta) + a_3(\vartheta) + \dots .$$

In the last equation the dots replace the remainder term in the expansion, $a_2(\vartheta) = \hat{a}_2(\vartheta, \vartheta)$, $a_3(\vartheta) = \hat{a}_3(\vartheta, \vartheta, \vartheta)$; \hat{a}_2 and \hat{a}_3 are bilinear and trilinear symmetric forms.

We estimate Φ in the norm of space $H^{2r,r}$, assuming that $\|w_\mu\|$, $|\dot{\omega}^1|$, and $|\mu|$ do not exceed a given number (for example, one):

$$(2.12) \quad \|\Phi\|_{H^{2r,r}} \leq C(|\dot{\omega}^1\mu| + |\alpha\mu^2| + |\alpha\dot{\omega}^1| + |\mu|\|\dot{w}\|^2 + |\dot{\omega}^1\|\|\dot{w}\|^2 + \alpha^2 + \|\dot{w}\|^2).$$

To obtain this estimate it is necessary to calculate the derivatives $D_\xi^p D_\tau^q \Phi$, where $p = (p_1, \dots, p_N)$, p_i and q are nonnegative numbers, $p_1 + \dots + p_N + 2q \leq 2r$, and then to use interpolational inequalities (see Chapter 4). Analogous estimates are given in [Vol 48].

We estimate the solution of equation (2.10) when

$$(2.13) \quad \varepsilon_0 + \varkappa/2 \leq \rho \leq M, \quad \|w_\mu\| + |\mu| \leq \varepsilon,$$

where ε is a sufficiently small number, and ε_0 and M are arbitrary positive numbers with $\varepsilon_0 \leq \varkappa/2$. From Proposition 1.5 we obtain, by virtue of (2.7),

$$(2.14) \quad \|\dot{w}\|^2 \leq C(\|\Phi\|_{H^{2r,r}} + |\dot{\omega}^1| + |\alpha\dot{\rho}| + |\alpha\mu|),$$

where we have taken into account the inequality

$$(2.15) \quad \|\dot{\omega}^1\| \leq C\alpha,$$

which follows from (2.8). It follows also from the same Proposition 1.5 that

$$\langle L^\rho \dot{w}^2, \varphi_k \rangle = 0 \quad (k = 0, 1, \dots, n).$$

Therefore, taking the inner product of (2.10) with φ_0 , we have

$$\dot{\omega}^1 + \langle \Phi, \varphi_0 \rangle = 0,$$

whence we have the estimate

$$(2.16) \quad |\dot{\omega}^1| \leq C\|\Phi\|_{H^{2r,r}}.$$

In order to estimate μ from (2.10) we introduce the function

$$w^* = 2 \operatorname{Re} \sum_{k=1}^n \alpha_k \varphi_k,$$

where the constants α_k are the same as in (2.8). Noting that $\partial v_k / \partial \tau = i v_k$, we obtain

$$\langle \partial \dot{w} / \partial \tau, w^* \rangle = 0,$$

and it follows from (1.53) that

$$\langle T \dot{w}^1, w^* \rangle = \alpha^2 \operatorname{Re} \dot{\lambda}_0.$$

Taking the inner product of (2.10) with w^* , we obtain

$$\alpha^2 \mu \operatorname{Re} \dot{\lambda}_0 + \langle \Phi, w^* \rangle = 0,$$

whence, noting that $\operatorname{Re} \dot{\lambda} \neq 0$, by Condition 3, we have

$$(2.17) \quad |\alpha\mu| \leq C\|\Phi\|_{H^{2r,r}}.$$

In a similar way we derive an estimate of $\dot{\rho}$ from (2.10). Namely, we introduce the function

$$w_* = -2 \operatorname{Im} \sum_{k=1}^n \alpha_k \varphi_k.$$

We may verify directly the validity of the equalities

$$(2.18) \quad \langle \partial \dot{w} / \partial \tau, w_* \rangle = \alpha^2, \quad \langle T \dot{w}, w_* \rangle = \alpha^2 \operatorname{Im} \dot{\lambda}_0,$$

and, consequently, from (2.10) we obtain

$$-\alpha^2 \dot{\rho} + \alpha^2 \mu \operatorname{Im} \dot{\lambda}_0 = \langle \Phi, w_* \rangle,$$

from which, with the aid of (2.17), we obtain

$$(2.19) \quad |\alpha \dot{\rho}| \leq C\|\Phi\|_{H^{2r,r}}.$$

In (2.13) we assume that ε is sufficiently small. Then, as is readily verified, the following estimates follow from (2.12), (2.14), (2.16), (2.17), and (2.19):

$$(2.20) \quad \|\dot{w}\| \leq C\alpha^2, \quad |\dot{\omega}| \leq C\alpha^2, \quad |\dot{\rho}| \leq C\alpha, \quad |\mu| \leq C\alpha.$$

If, in addition, we also take into account estimate (2.15), then from (2.5) we obtain the estimate

$$\|w_\mu\| \leq C\alpha.$$

In combination with (2.9), this leads to the result that α is equivalent to $\|w_\mu\|$. In other words, the norm of the projection of w_μ onto the subspace of solutions of equation (2.6) is equivalent to the norm of the same function w_μ .

It follows from (2.20) that we can set

$$(2.21) \quad \dot{w} = \alpha y_1, \quad \dot{\omega} = \alpha^2 y, \quad \dot{\omega} = \alpha^2 \dot{\omega}, \quad \dot{\rho} = \alpha \rho_1, \quad \mu = \alpha \mu_1.$$

Also, we set

$$(2.22) \quad \alpha_k = \alpha \chi_k \quad (k = 1, \dots, n),$$

so that

$$(2.23) \quad y_1 = \operatorname{Re}(\chi_1 v_1 + \dots + \chi_n v_n), \\ |\chi_1|^2 + \dots + |\chi_n|^2 = 1.$$

To obtain further estimates, we introduce function y_2 defined by the equation

$$(2.24) \quad Ly_2 + \omega_2 v_0 + a_2(y_1) = 0,$$

subject to the conditions

$$(2.25) \quad \langle y_2, \varphi_k \rangle = 0 \quad (k = 0, 1, \dots, n).$$

Here the constant ω_2 is selected so that the condition for solvability of equation (2.24) is satisfied:

$$(2.26) \quad \omega_2 = -\langle a_2(y_1), \varphi_0 \rangle.$$

With ω_2 selected in this way, the sum of the last two terms on the left-hand side of (2.24) is orthogonal to φ_0 , and also to φ_k ($k = 1, \dots, n$). The latter may be verified directly by taking into account the form of function y_1 from (2.23) and also from the fact that a_2 is a quadratic form. Thus, on the basis of Proposition 1.5, a solution y_2 of equation (2.24) satisfying conditions (2.25) exists.

We introduce function $\overset{3}{y}$ and a constant $\overset{3}{\omega}$ as follows:

$$(2.27) \quad \overset{2}{y} = y_2 + \overset{3}{y}, \quad \overset{2}{\omega} = \omega_2 + \overset{3}{\omega}.$$

Substitute (2.27) into (2.21), and the resulting expression into (2.10) and (2.11). It leads to

$$(2.28) \quad L\overset{3}{y} + \overset{3}{\omega}\overset{3}{v}'_0 + \mu_1 T y_1 - \rho_1 \frac{\partial y_1}{\partial \tau} + \alpha \Phi_1 = 0,$$

where Φ_1 is bounded in the norm of space $H^{2r,r}$. Repeating the previous considerations, we obtain from (2.28) the estimate

$$\|\overset{3}{y}\| \leq C\alpha, \quad |\overset{3}{\omega}| \leq C\alpha, \quad |\mu_1| \leq C\alpha, \quad |\rho_1| \leq C\alpha,$$

and we can set

$$(2.29) \quad \overset{3}{y} = \alpha y_3, \quad \overset{3}{\omega} = \alpha \omega_3, \quad \mu_1 = \alpha \mu_2, \quad \rho_1 = \alpha \rho_2.$$

Taking the preceding equalities into account, this leads to the following form for the solution of the problem in question:

$$(2.30) \quad v = \tilde{v}_\mu + \alpha y_1 + \alpha^2 y_2 + \alpha^3 y_3, \quad \omega = \tilde{\omega}_\mu + \alpha \omega_1 + \alpha^2 \omega_2 + \alpha^3 \omega_3, \\ \rho = \rho_0 + \alpha^2 \rho_2, \quad \mu = \alpha^2 \mu_2.$$

Substitution of (2.29) into equation (2.28) leads to the equation

$$(2.31) \quad L y_3 + \omega_3 \tilde{v}'_0 + \mu_2 T y_1 - \rho_2 \frac{\partial y_1}{\partial \tau} + \omega_2 \frac{\partial y_1}{\partial \xi_1} + 2\hat{a}_2(y_1, y_2) + a_3(y_1) + \alpha \Phi_2 = 0,$$

where Φ_2 is bounded in the norm of space $H^{2r,r}$. In addition, it also follows from the preceding that

$$(2.32) \quad \langle y_3, \varphi_k \rangle = 0 \quad (k = 0, 1, \dots, n).$$

From Proposition 1.5 we conclude that

$$(2.33) \quad \left\langle \mu_2 T y_1 - \rho_2 \frac{\partial y_1}{\partial \tau} + \omega_2 \frac{\partial y_1}{\partial \xi_1} + 2\hat{a}_2(y_1, y_2) + a_3(y_1) + \alpha \Phi_2, \varphi_k \right\rangle = 0 \\ (k = 0, 1, \dots, n).$$

From this equation we can express μ_2 and ρ_2 . To do that, let us introduce the function

$$(2.34) \quad \overset{*}{y} = 2 \operatorname{Re} \sum_{k=1}^n \chi_k \varphi_k,$$

where χ_k is given by equation (2.22). We may verify directly that

$$\left\langle \frac{\partial y_1}{\partial \tau}, \overset{*}{y} \right\rangle = i, \quad \langle T y_1, \overset{*}{y} \rangle = \dot{\lambda}_0.$$

Therefore, from (2.33) we obtain

$$(2.35) \quad \left\langle \omega_2 \frac{\partial y_1}{\partial \xi_1} + 2\widehat{a}_2(y_1, y_2) + a_3(y_1) + \alpha \Phi_2, y^* \right\rangle = i\rho_2 - \dot{\lambda}_0 \mu_2,$$

from which we can obtain μ_2 and ρ_2 , since, by virtue of Condition 3, $\operatorname{Re} \dot{\lambda}_0 \neq 0$.

For further study of the representation of the solutions obtained in the form (2.30), we introduce the manifold \mathfrak{M} , for the definition of which we consider the function

$$(2.36) \quad \Psi_k(\mu_2, \rho_2, \chi) = \left\langle \mu_2 T y_1 - \rho_2 \frac{\partial y_1}{\partial \tau} + \omega_2 \frac{\partial y_1}{\partial \xi_1} + 2\widehat{a}_2(y_1, y_2) + a_3(y_1), \varphi_k \right\rangle \\ (k = 1, \dots, n).$$

Here $y_1 = \operatorname{Re}(\chi_1 v_1 + \dots + \chi_n v_n)$, $\chi = (\chi_1, \dots, \chi_n)$ is a complex n -dimensional vector, ω_2 is defined by equation (2.26), and y_2 is the solution of system (2.24), satisfying the conditions (2.25). As explained above, a solution of such an equation exists and is unique.

We consider the system of equations

$$(2.37) \quad \Psi_k(\mu_2, \rho_2, \chi) = 0 \quad (k = 1, \dots, n).$$

We can eliminate μ_2 and ρ_2 from these equations. As in equation (2.35), we obtain

$$(2.38) \quad \left\langle \omega_2 \frac{\partial y_1}{\partial \xi_1} + 2\widehat{a}_2(y_1, y_2) + a_3(y_1), y^* \right\rangle = i\rho_2 - \dot{\lambda}_0 \mu_2,$$

where y^* has the form (2.34) with the vector χ in question, and we then substitute μ_2 and ρ_2 into (2.37).

DEFINITION 2.2. \mathfrak{M} is the set of points of the unit sphere

$$|\chi_1|^2 + \dots + |\chi_l|^2 = 1,$$

satisfying the system of equations (2.37), where μ_2 and ρ_2 are given by equation (2.38).

When $n = 1$, the set \mathfrak{M} obviously coincides with the circle $|\chi_1| = 1$.

PROPOSITION 2.2. *In order for a solution branching from a plane wave in the sense of Definition 2.1 to exist, it is necessary that \mathfrak{M} be nonempty.*

PROOF. As $\mu \rightarrow 0$, the set of vectors (χ_1, \dots, χ_n) , given by equation (2.22), has limit points. Since, moreover, $\alpha \rightarrow 0$, it is then easy to see from (2.33) and (2.35) that these limit points belong to the set \mathfrak{M} .

We note, as was shown above, that the number α is equivalent to $\|w_\mu\|$ for $\mu \in \Delta$. It is convenient to consider, as the independent parameter, α instead of μ . In addition to Conditions 1°–3°, appearing in Definition 2.1, we introduce the following condition.

4°. The vector $\chi = (\chi_1, \dots, \chi_n)$, defined by equation (2.22), has, for sufficiently small α , the form

$$(2.39) \quad \chi = p + \alpha \overset{1}{\chi}(\alpha),$$

where $\overset{1}{\chi}(\alpha)$ is a bounded function of α , and $p = (p_1, \dots, p_n)$, $|p_1|^2 + \dots + |p_n|^2 = 1$.

It follows from the preceding that $p \in \mathfrak{M}$. We can now obtain the representation (2.30) in another form in which the leading term of the deviation from a planar wave is determined by a point of the manifold \mathfrak{M} . Namely, let us set

$$(2.40) \quad \zeta_1 = \operatorname{Re} \sum_{k=1}^n p_k v_k,$$

where $(p_1, \dots, p_n) = p$. Then, by virtue of (2.39), we can write vector y_1 (see (2.23)) in the form

$$y_1 = \zeta_1 + \alpha \zeta^1.$$

In place of y_2 we can now introduce function ζ_2^0 , which is a solution of an equation of the form (4.35) with y_1 replaced by ζ_1 :

$$(2.41) \quad L\zeta_2^0 + \omega_2^0 v_0 + a_2(\zeta_1) = 0,$$

where it is assumed the following conditions are satisfied:

$$\langle \zeta_2^0, \varphi_k \rangle = 0 \quad (k = 0, 1, \dots, n).$$

Here

$$(2.42) \quad \omega_2^0 = -\langle a_2(\zeta_1), \varphi_0 \rangle.$$

We note that

$$\|a_2(y_1) - a_2(\zeta_1)\| \leq M\alpha.$$

(Here, and in what follows, M represents various constants.)

Therefore

$$|\omega_2 - \omega_2^0| \leq M\alpha,$$

and it follows from estimate (1.50) that

$$\|y_2 - \zeta_2^0\| \leq M\alpha.$$

Consequently,

$$y_2 = \zeta_2^0 + \alpha \zeta^1, \quad \omega_2 = \omega_2^0 + \alpha \omega_2^1.$$

Substitution into (2.30) gives

$$(2.43) \quad \begin{aligned} v &= \tilde{v}_\mu + \alpha \zeta_1 + \alpha^2 \zeta_2^0 + \alpha^3 \zeta_3, & \omega &= \tilde{\omega}_\mu + \alpha^2 \omega_2^0 + \alpha^3 \omega_3^0, \\ \rho &= \rho_0 + \alpha^2 \rho_2, & \mu &= \alpha^2 \mu_2, \end{aligned}$$

where $\zeta_2 = \zeta^1 + \zeta_2^0$, $\zeta_3 = \zeta^2 + y_3$, $\omega_3^0 = \omega_3 + \omega_2^1$.

We note that ζ_2 is also a solution of equation (2.41); however, the condition of orthogonality to φ_k cannot be satisfied.

Thus the following theorem has been proved.

THEOREM 2.1. *Every solution $v_\mu(\xi, \tau)$, which branches off from a planar wave (in the sense of Definition 2.1), can be represented in the form (2.30). If, in addition, condition 4° is satisfied, it may then be represented in the form (2.43),*

where the leading term ζ_1 in the branch-off from a planar wave is determined by point p of manifold \mathfrak{M} .

REMARK. In going from representation (2.30) to representation (2.43), nowhere have we used the fact that vector χ lies on the unit sphere.

2.2. Manifold \mathfrak{M} . Let us examine the set \mathfrak{M} in more detail.

PROPOSITION 2.3. *If $\chi \in \mathfrak{M}$, then $\gamma\chi \in \mathfrak{M}$, where γ is an arbitrary complex number, equal to one in absolute value.*

PROOF. Let $\chi \in \mathfrak{M}$ and $\gamma = \exp(i\sigma)$, where σ is a real number. It is obvious that $\gamma\chi$ is a point of the unit sphere. We introduce the notation $\widehat{y}_1(\xi, \tau) = y_1(\xi, \tau + \sigma)$, $\widehat{y}_2(\xi, \tau) = y_2(\xi, \tau + \sigma)$. It is clear that

$$\begin{aligned} \operatorname{Re}(\gamma\chi_1 v_1 + \dots + \gamma\chi_n v_n) &= \widehat{y}_1, \\ -\langle a_2(\widehat{y}_1, \varphi_0) \rangle &= -\langle a_2(y_1, \varphi_0) \rangle = \omega_2. \end{aligned}$$

If in (2.24) we make a shift of τ in σ , we find that this equation holds with y_1 and y_2 replaced by \widehat{y}_1 and \widehat{y}_2 . From (2.25) it follows that

$$\langle \widehat{y}_2, \widehat{\varphi}_k \rangle = 0 \quad (k = 0, 1, \dots, n),$$

where

$$\widehat{\varphi}_k(\xi, \tau) = \varphi_k(\xi, \tau + \sigma) = \gamma\varphi_k(\xi, \tau).$$

Therefore,

$$\langle \widehat{y}_2, \varphi_k \rangle = 0 \quad (k = 0, 1, \dots, n),$$

so that \widehat{y}_2 corresponds to vector $\gamma\chi$. In order to obtain μ_2 and ρ_2 corresponding to $\gamma\chi$ from (2.38), we must go from y_1, y_2 , and \dot{y} to $\widehat{y}_1, \widehat{y}_2$, and $\dot{\widehat{y}}(\xi_1, \tau + \sigma)$. It is obvious here that μ_2 and ρ_2 do not change. Thus, $\Psi_k(\mu_2, \rho_2, \gamma\chi)$ has the same form as $\Psi_k(\mu_2, \rho_2, \chi)$, but with y_1 and y_2 replaced by \widehat{y}_1 and \widehat{y}_2 , which, obviously, is equal to the right-hand side of (2.36) with $\varphi_k(\xi, \tau)$ replaced by $\varphi_k(\xi, \tau - \sigma) = \overline{\gamma}\varphi_k(\xi, \tau)$.

We have established the equation

$$\Psi_k(\mu_2(\gamma\chi), \rho_2(\gamma\chi), \gamma\chi) = \gamma\Psi_k(\mu_2(\chi), \rho_2(\chi), \chi),$$

from whence the proposition follows. □

In (2.36) we go to real functions, separating the real and imaginary parts. We obtain

$$\Psi = (\Psi_{11}, \Psi_{12}, \dots, \Psi_{n1}, \Psi_{n2}), \quad \Psi_k = \Psi_{k1} + i\Psi_{k2}.$$

In χ_k we also separate the real and imaginary parts: $\chi_k = \chi_{k1} + i\chi_{k2}$. Let $\mathcal{J}(\mu_2, \rho_2, \chi)$ be the matrix of the partial derivatives of Ψ with respect to $\mu_2, \rho_2, \chi_{11}, \dots, \chi_{n2}$. This matrix has dimensions $2n \times (2n + 2)$.

DEFINITION 2.3. We call a point $\chi \in \mathfrak{M}$ an ordinary point of manifold \mathfrak{M} if matrix $\mathcal{J}(\mu_2, \rho_2, \chi)$, where μ_2 and ρ_2 are determined with respect to χ by equations (2.38), has rank $2n$.

PROPOSITION 2.4. *When $n = 1$ all points of manifold \mathfrak{M} are ordinary points.*

PROOF. The Jacobian may be calculated directly:

$$\frac{\partial(\Psi_{11}, \Psi_{12})}{\partial(\mu_2, \rho_2)} = -\operatorname{Re} \dot{\lambda}_0,$$

from whence the proposition follows. □

2.3. Existence of solutions. As was shown in the preceding section, each solution which branches off from a planar wave (satisfies conditions $1^\circ - 4^\circ$) can be represented in the form (2.43); and, also, to this solution there corresponds a point p of the manifold \mathfrak{M} . We show now that to each ordinary point p of manifold \mathfrak{M} (if it exists) there corresponds a solution of the problem in question, satisfying conditions $1^\circ - 4^\circ$. More precisely, we have the following theorem.

THEOREM 2.2. *We assume that manifold \mathfrak{M} is not empty and contains ordinary points. Further, let (p_1, \dots, p_n) be an ordinary point of manifold \mathfrak{M} . Then for all sufficiently small $|\alpha|$ there exists a solution (v, ρ, ω, μ) , satisfying conditions $1^\circ - 4^\circ$ and having the form (2.43), where ζ_1 is given by equation (2.40), ω_2^0 is given by equation (2.42), ζ_2 is a solution of equation*

$$L\zeta_2 + \omega_2^0 v_0 + a_2(\zeta_1) = 0,$$

$\zeta_2 \in H^{2r+2, r+1}$, $\zeta_3 \in H^{2r+2, r+1}$, and ρ_2, ω_3, μ are continuous functions of α .

PROOF. We seek a solution in the form (2.30) for sufficiently small $|\alpha|$, $\rho_0 = \varkappa$, where y_1 has the form (2.23), with vector $\chi = (\chi_1, \dots, \chi_n)$ being a function of α and subject to determination. In (2.30) we assume that ω_2 is a function of χ , being given by equation (2.26); $y_2 \in H^{2r+2, r+1}$ and is determined as a solution of equation (2.24), satisfying conditions (2.25). As was noted above, a solution of this equation exists. Further, ω_3, ρ_2, μ_2 , and y_3 are also functions of α and are determined as solutions of equation (2.31), satisfying condition (2.32). The function

$$\Phi_2 = \Phi_2 \left(y_1, y_2, y_3, \frac{\partial y_2}{\partial \xi_1}, \frac{\partial y_2}{\partial \tau}, \frac{\partial y_3}{\partial \xi_1}, \frac{\partial y_3}{\partial \tau}, \rho_2, \omega_2, \omega_3, \mu_2, \alpha \right),$$

appearing in (2.31), is obtained as the result of substitution (2.30) into the initial system. We prove the existence of solutions of system (2.31) satisfying conditions (2.32). We write these conditions in real form, setting

$$(2.44) \quad \begin{aligned} \varphi_k &= \psi_k + i\psi_{k+n} & (k = 1, \dots, n), \\ \langle y_3, \psi_k \rangle &= 0 & (k = 0, 1, \dots, 2n), \end{aligned}$$

ψ_0 is a solution of equation (1.16); see also (1.37). We go over to the real and imaginary parts of function $v_k(\xi, \tau)$,

$$v_k = v_k^r + i v_{k+n}^i \quad (k = 1, \dots, n).$$

We introduce the operator

$$L_1 y = Ly + \sum_{k=1}^{2n} \langle y, \psi_k \rangle v_k^r,$$

having the same domain of definition as operator L . Along with (2.31) we consider

the equations:

$$(2.45) \quad L_1 y_3 + \omega_3 \tilde{v}'_0 + \mu_2 T y_1 - \rho_2 \frac{\partial y_1}{\partial \tau} + \omega_2 \frac{\partial y_1}{\partial \xi_1} + 2\hat{a}_2(y_1, y_2) + a_3(y_1) + \alpha \Phi_2 = 0,$$

$$(2.46) \quad \left\langle \mu_2 T y_1 - \rho_2 \frac{\partial y_1}{\partial \tau} + \omega_2 \frac{\partial y_1}{\partial \xi_1} + 2\hat{a}_2(y_1, y_2) + a_3(y_1) + \alpha \Phi_2, \psi_k \right\rangle = 0$$

$$(k = 1, \dots, 2n).$$

System (2.45), (2.46) is obviously equivalent to system (2.31), (2.44).

We shall assume that when $\alpha = 0$

$$\chi_k = p_k \quad (k = 1, \dots, n),$$

and we find the solution of equation (2.45) when $\alpha = 0$. Since $(p_1, \dots, p_n) \in \mathfrak{M}$, we have equation (2.46) for $\alpha = 0$, whence it follows that equation (2.45) is solvable for $\alpha = 0$. We assume here that y_1, ω_2, y_2 correspond to the vector (p_1, \dots, p_n) . We denote the solution $y_3, \omega_3, \rho_2, \mu_2$ of equation (2.45) for $\alpha = 0$ by $\overset{0}{y}_3, \overset{0}{\omega}_3, \overset{0}{\rho}_2, \overset{0}{\mu}_2$. To establish the existence of a solution of system (2.45), (2.46) for $\alpha \neq 0$ we apply the implicit function theorem (see, for example, [Kant 1]). Consider the matrix $\mathcal{J}(\mu_2, \rho_2, \chi)$, involved in Definition 2.3. In it we select the ranking minor. It determines two free variables, namely, the real coordinates of point μ_2, ρ_2, χ , which we denote by σ_1 and σ_2 ; the remaining variables we denote by $q = (q_1, \dots, q_{2n})$. Let $\overset{0}{\sigma}_1, \overset{0}{\sigma}_2$ be the values of the variables σ_1, σ_2 , corresponding to the point $(\overset{0}{\mu}_2, \overset{0}{\rho}_2, p)$. In accordance with the implicit function theorem we show that there exists a solution y_3, ω_3 of system (2.45), (2.46) for all $\alpha, \sigma_1, \sigma_2$, lying in a sufficiently small neighborhood of the point $(0, \overset{0}{\sigma}_1, \overset{0}{\sigma}_2)$. To do this, we introduce the space $E_1 = H^{2r+2, r+1} \times \mathbb{R}^{2n+4}$, the points of which are $(y_3, \omega_3, q, \alpha, \sigma_1, \sigma_2)$. Further, we introduce the space $E_2 = H^{2r, r} \times \mathbb{R}^{2n}$. Consider the nonlinear operator $\underline{\Phi} = (\underline{\Phi}_1, \underline{\Phi}_2)$, acting from E_1 into E_2 , in the following way. Operator $\underline{\Phi}_1$ acts from E_1 into $H^{2r, r}$ and is specified by the left-hand side of equation (2.45). This is to be understood as follows: from the point (q, σ_1, σ_2) we recover (μ_2, ρ_2, χ) , and then y_1, ω_2, y_2 are obtained as described above. Operator $\underline{\Phi}_2$ acts from E_1 into \mathbb{R}^{2n} and is specified by the left-hand side of equation (2.46). As shown above, the point

$$(2.47) \quad (\overset{0}{y}_3, \overset{0}{\omega}_3, \overset{0}{q}, \overset{0}{\sigma}_1, \overset{0}{\sigma}_2, 0)$$

is carried over by operator $\underline{\Phi}$ into the zero point of the space E_2 . Let $\underline{\Phi}' = (\underline{\Phi}'_1, \underline{\Phi}'_2)$ be the Fréchet differential of operator $\underline{\Phi}$ with respect to the variables y_3, ω_3, q , considered at the point (2.47). We need to prove the existence of a continuous inverse to $\underline{\Phi}'$, defined on the whole space E_2 . To do this, we consider the system

$$(2.48) \quad \underline{\Phi}'_1(y_3, \omega_3, q) = f_1 \quad (f_1 \in H^{2r, r}),$$

$$(2.49) \quad \underline{\Phi}'_2 q = f_2 \quad (f_2 \in \mathbb{R}^{2n}).$$

From the way in which the variables q were chosen in accordance with the ranking

minor of matrix \mathcal{J} , it follows that equation (2.49) is solvable uniquely. Substituting q into (2.48), we obtain the following equation for determining y_3 and ω_3 :

$$L_1 y_3 + \omega_3 \tilde{v}'_0 = \widehat{f}_1,$$

where $\widehat{f}_1 \in H^{2r,r}$ is known. From this equation y_3 and ω_3 are determined uniquely. Thus all the conditions for the implicit function theorem are satisfied and the existence of solutions of system (2.45), (2.46) is thereby established. \square

§3. Stability of branching-off solutions

We proceed to an examination of the stability of solutions appearing with the loss of stability of a planar wave. Without going into detailed proofs, we present the basic ideas.

We seek a solution of the linearized problem (2.19) of Chapter 6 in the form

$$\begin{aligned} w &= c(\alpha) \frac{\partial \tilde{v}_\mu}{\partial \xi_1} + \alpha w_1 + \alpha^2 w_2 + \alpha^3 w_3(\alpha), \\ \lambda &= \alpha^2 \lambda_2(\alpha), \end{aligned}$$

subject to the conditions

$$\langle w_k, \varphi_j \rangle = \langle w_k, \bar{\varphi}_j \rangle = 0 \quad (k = 2, 3; \quad j = 0, \dots, n),$$

where

$$w_1 = b_1(\alpha)v_1 + \dots + b_n(\alpha)v_n + b_{n+1}(\alpha)\bar{v}_1 + \dots + b_{2n}(\alpha)\bar{v}_n;$$

w_2 is a solution of the equation

$$Lw_2 + 2\widehat{a}_2(y_1, w_1) = d_0 \tilde{v}'_0.$$

Here we have used the notation

$$c(\alpha)\lambda_2(\alpha) = d(\alpha) = d_0 + \alpha d_1(\alpha).$$

We obtain, with respect to the unknowns

$$d_1(\alpha), w_3(\alpha), \lambda_2(\alpha), b_1(\alpha), \dots, b_{2n}(\alpha),$$

the equation

$$\begin{aligned} (3.1) \quad Lw_3 - \rho_2 \frac{\partial w_1}{\partial \tau} + \mu_2 T w_1 + \omega_2 \frac{\partial w_1}{\partial \xi_1} + 2\widehat{a}_2(y_1, w_2) + 2\widehat{a}_2(y_2, w_1) \\ + 3\widehat{a}_3(y_1, y_1 w_1) - d_0 \frac{\partial y_1}{\partial \xi_1} = \dot{\lambda}_2 w_1 + d_1 \tilde{v}'_0 + O(\alpha). \end{aligned}$$

We turn our attention to the fact that the nonhomogeneity on the left-hand side of (3.1) can be deduced upon taking the Gateaux differential of Π (see formula (2.11) of Chapter 6) with respect to $\chi_1, \dots, \chi_n, \bar{\chi}_1, \dots, \bar{\chi}_n$ in the direction of b_1, b_2, \dots, b_{2n} . It follows from this that $\lambda_2(0)$ is an eigenvalue of matrix \mathcal{D} , introduced in Chapter 6. Solvability of (3.1) for $\alpha > 0$ is established in accordance with the implicit function theorem, since the corresponding Fréchet differential, taken at $\alpha = 0$, is invertible.

Part III

Waves in Chemical Kinetics and Combustion

Waves in Chemical Kinetics

§1. Equations of chemical kinetics

1.1. Nondistributed system. We consider a system of n reactions

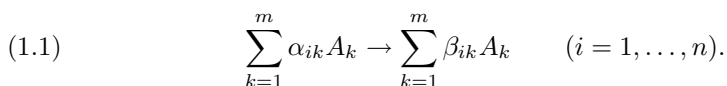

Here A_k ($k = 1, \dots, m$) denote substances taking part in the reactions; α_{ik} , β_{ik} are nonnegative integers, the stoichiometric coefficients. In order to minimize the notation, we denote concentrations of the substances by the same letters. If no account is taken of spatial distributions of concentrations and it is assumed that reactions take place at constant volume, then the change in concentrations with time is described by the following system of equations (see, for example, [Ema 1]):

$$(1.2) \quad \frac{dA_k}{dt} = \sum_{i=1}^n \gamma_{ik} w_i \quad (k = 1, \dots, m),$$

where w_i is the rate of the i th reaction, and $\gamma_{ik} = \beta_{ik} - \alpha_{ik}$. We shall assume that the rates w_i may be expressed in terms of the concentrations in the following way:

$$(1.3) \quad w_i = K_i(T) A_1^{\nu_{i1}} \times \dots \times A_m^{\nu_{im}} g_i(A).$$

Here $A = (A_1, \dots, A_m)$ is the vector of concentrations; ν_{ik} are arbitrary real numbers such that $\nu_{ik} \geq 1$ if $\alpha_{ik} \neq 0$, and $\nu_{ik} = 0$ if $\alpha_{ik} = 0$; $g_i(A) > 0$ if $A_k \geq 0$ ($k = 1, \dots, m$); the functions $K_i(T) \geq 0$ describe the temperature dependence of the reaction rate. Expression (1.3) encompasses the most frequently encountered forms for the dependence of rate on concentrations. In particular, $\nu_{ik} = \alpha_{ik}$, $g_i(A) = 1$ corresponds to the law of mass action.

In the case of a nonisothermal process, there must be adjoined to the system (1.2) an equation describing the variation of temperature with time. It has the form

$$(1.4) \quad \frac{dT}{dt} = \sum_{i=1}^n q_i w_i,$$

where q_i denotes thermal effect of the reactions, which we assume to be constant.

It is convenient to write system (1.2) in matrix form:

$$(1.5) \quad \frac{dA}{dt} = \Gamma w,$$

where, as above, A is the vector of concentrations, $w = (w_1, \dots, w_n)$ is the vector of reaction rates, and

$$(1.6) \quad \Gamma = \begin{pmatrix} \gamma_{11} & \cdots & \gamma_{n1} \\ \dots & \dots & \dots \\ \gamma_{1m} & \cdots & \gamma_{nm} \end{pmatrix}$$

is the matrix of stoichiometric coefficients. In system (1.5) vectors A and w are treated as columns, while Γw is to be understood as the product of Γ by column w .

Let the rank of matrix Γ be r . Then for $m > r$ there are linear relations among the rows of matrix Γ :

$$(1.7) \quad \sum_{k=1}^m \gamma_{ik} \sigma_k = 0 \quad (i = 1, \dots, n).$$

To each solution $\sigma_1, \dots, \sigma_m$ of equation (1.7) there corresponds a balance of mass:

$$(1.8) \quad \sum_{k=1}^m \sigma_k A_k(t) = \text{const.}$$

This follows directly from (1.2) if we multiply the equations by σ_k and add. System (1.7) has $m - r$ linearly independent solutions. We denote them by σ_k^l ($k = 1, \dots, m; l = 1, \dots, m - r$). To each such solution there corresponds a plane

$$(1.9) \quad \sum_{k=1}^m \sigma_k^l A_k = a^l \quad (l = 1, \dots, m - r)$$

in the m -dimensional space \mathbb{R}^m . It follows from the aforesaid that this plane is invariant for system (1.2), i.e., if the initial values of A_k (for $t = 0$) belong to this plane, then the solutions of system (1.2) belong to it for all $t \geq 0$. Moreover, it is known (see, for example, [Vol 9]) that if the initial conditions for system (1.2) are nonnegative, which, understandably, corresponds to the physical meaning of concentrations, then solutions of system (1.2) are also nonnegative. It is therefore natural to consider only nonnegative solutions of system (1.2). It follows, from what has been said, that the polyhedron Π in space \mathbb{R}^m defined by equations (1.9) and inequalities $A_k \geq 0$ ($k = 1, \dots, m$) is invariant for system (1.2) in the sense indicated above: if the initial conditions belong to polyhedron Π , then solutions of the system will belong to this polyhedron for all $t \geq 0$. We shall refer to polyhedron Π as the balance polyhedron. Numbers a^l appearing in (1.9) are determined, as a rule, by assigning initial conditions for system (1.2), or (as will be seen from what follows) by assigning boundary conditions in the case of a spatial distribution for the system. In the case $m = r$ the balance polyhedron coincides with the octant $A_k \geq 0$ ($k = 1, \dots, m$).

It is convenient to specify polyhedron Π parametrically in the form

$$(1.10) \quad A_k = \sum_{i=1}^r p_{ik} u_i + A_k^0 \quad (k = 1, \dots, m),$$

where the point $u = (u_1, \dots, u_r)$ ranges over some polyhedron of space \mathbb{R}^r , and $A^0 = (A_1^0, \dots, A_m^0)$ is a given fixed point belonging to Π . We write (1.10) in matrix form:

$$(1.11) \quad A = Pu + A^0,$$

where

$$P = \begin{pmatrix} p_{11} \cdots p_{r1} \\ \dots\dots\dots \\ p_{1m} \cdots p_{rm} \end{pmatrix}.$$

Matrix P , with whose aid a parametric representation of polyhedron Π is specified, can be chosen in various ways. Selection of this matrix turns out to be important for the sequel, since, by means of the substitution (1.11), the system (1.2) and the corresponding system in the spatially distributed case reduce to a new system of equations possessing certain properties (for example, positiveness of the source, monotonicity). Therefore, we describe the general form of matrix P , which is easy to do. Indeed, let $\sigma^l = (\sigma_1^l, \dots, \sigma_m^l)$ be the solution vector for system (1.9). Since $A - A^0$ is orthogonal to σ^l , then, obviously, the columns of matrix P must be orthogonal to σ^l ($l = 1, \dots, m - r$), i.e., the columns of matrix P form a basis of subspace R_0^r of space \mathbb{R}^m , orthogonal to vectors σ^l ($l = 1, \dots, m - r$). On the other hand, it follows from (1.7) that the columns of matrix Γ belong to R_0^r and, since the rank of matrix Γ is equal to r , the columns of matrix P are then linear combinations of the columns of matrix Γ . Thus, for P we can take an arbitrary matrix whose columns are linearly independent and are linear combinations of the columns of matrix Γ .

A simpler, but rather important, special case is the case in which $r = n$. This means that the columns of matrix Γ are linearly independent. In this case we say that the reactions (1.1) are linearly independent, since the functions

$$(1.12) \quad \gamma_i(A) = \sum_{k=1}^m \beta_{ik} A_k - \sum_{k=1}^m \alpha_{ik} A_k = \sum_{k=1}^m \gamma_{ik} A_k \quad (i = 1, \dots, n)$$

are linearly independent. For linearly independent reactions, for P we can take the matrix Γ .

We consider now equation (1.4) for the temperature. Let $q = (q_1, \dots, q_n)$ be the vector of thermal effects of the reactions. We assume that a vector τ exists such that

$$(1.13) \quad \tau\Gamma = q.$$

This agrees with known physical representations concerning nonisothermal reactions. From (1.4) and (1.5) it follows that

$$(1.14) \quad T(t) - \tau A(t) = \text{const}.$$

We can describe an invariant set, including the temperature T , by adjoining

to (1.11) the equation

$$(1.15) \quad T = \tau Pu + T^0.$$

Thus we obtain an invariant polyhedron in $(m + 1)$ -dimensional space of concentrations A and temperature T . We denote this polyhedron by $\widehat{\Pi}$.

We now present a class of chemical reactions (1.1) of importance for the sequel. Following the terminology introduced earlier, we speak of a system of reactions (1.1) as reactions with an open graph if there exists a vector s such that

$$(1.16) \quad s\Gamma < 0.$$

Let $s = (s_1, \dots, s_m)$. Relation (1.16) then can be written as

$$\sum_{k=1}^m \alpha_{ik} s_k > \sum_{k=1}^m \beta_{ik} s_k \quad (i = 1, \dots, n).$$

It is easy to see that reactions with an open graph cannot contain reversible stages. However, they form a very broad class of irreversible reactions encompassing the majority of irreversible reactions arising naturally in chemical kinetics. To this class, in particular, belong all linearly independent reactions since in this case the system of equations $s\Gamma = -\mu$, with positive vector μ , is solvable. By virtue of (1.13), the class in question also includes reactions with positive thermal effects.

We consider the stationary points of the kinetic system (1.5) in the case of reactions with an open graph. It follows directly from (1.5) and (1.6) that at the stationary points

$$(1.17) \quad w_i = 0 \quad (i = 1, \dots, n).$$

This means, based on (1.3), that at stationary points some concentrations vanish, i.e., all the stationary points are located on the boundary of the balance polyhedron.

We introduce the function

$$(1.18) \quad V(A) = (s, A),$$

where, as usual, (s, A) denotes the scalar product of vectors. This function is a Lyapunov function for system (1.5) since, on the basis of (1.16), its derivative with respect to t is, by virtue of system (1.5), negative along the trajectories of system (1.5) outside of the stationary points and vanishes at the stationary points.

We shall assume that function $V(A)$ is bounded from below on the polyhedron Π . This is natural for chemical kinetics and holds, for example, if $s \geq 0$ or polyhedron Π is bounded.

It follows from the boundedness from below of function $V(A)$ on Π that this function attains its smallest value on Π , which we denote by V_{\min} . The smallest value may be attained at more than one point. Let Π^+ be the set of those $A \in \Pi$ for which

$$(1.19) \quad V(A) = V_{\min}.$$

It is clear, from the linearity of function $V(A)$, that Π^+ is a face of the polyhedron Π . Moreover, all points $A \in \Pi^+$ are stationary points of system (1.5). To each concentration $A^+ \in \Pi^+$ there corresponds a temperature T^+ , which can be calculated from (1.15) if for u we substitute u^+ corresponding to A^+ . Thus we obtain a set of stationary points A^+, T^+ of the kinetic system (1.5), (1.4),

which we denote by $\widehat{\Pi}^+$. The set $\widehat{\Pi}^+$ is an asymptotically stable stationary set for system (1.5), (1.4) in $\widehat{\Pi}$. This follows directly from the properties of function $V(A)$.

In the invariant polyhedron $\widehat{\Pi}$ there can also be other stationary points of system (1.5), (1.4), i.e., stationary points \overline{A} , \overline{T} , at which $V(\overline{A}) > V_{\min}$. Assume that \overline{A} , \overline{T} is isolated in $\widehat{\Pi}$. We show that it is unstable. Indeed, let us join \overline{A} with A^+ by a rectilinear segment. Function $V(A)$ is linear and is therefore strictly decreasing from \overline{A} to A^+ . Thus, taking point A^0 arbitrarily close to \overline{A} and lying on the indicated segment, we find that $V(A^0) < V(\overline{A})$ and, consequently, the trajectory, starting at A^0 , will “depart” from \overline{A} since along it $V(A)$ is decreasing. Similarly, we can show that an isolated stationary face $\overline{\Pi}$ not intersecting $\widehat{\Pi}^+$ is also unstable: there exists a neighborhood of face $\overline{\Pi}$ in $\widehat{\Pi}$ such that trajectories starting from certain points of this neighborhood, arbitrarily close to $\overline{\Pi}$, depart from this neighborhood and do not return to it.

We illustrate the above with an example, which is of independent interest as the model of a cold flame. We shall return to this example again in §3, where, as a consequence of general results, the existence and stability of a cold flame, described by this model, will be proved. We consider the following three stages of a general scheme for the oxidation reaction of carbon bisulfide (see [Kon 1, Nov 3, Zel 5]):

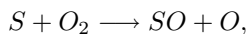
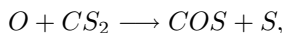

We denote CS_2 , O , S , O_2 , SO , by A_1 , A_2 , A_3 , A_4 , A_5 , respectively (SO_2 and COS need not be taken into account). In this notation the scheme for the reactions may be written in the form

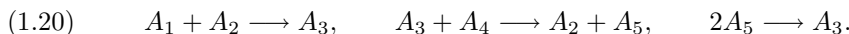

System (1.2), in the given case, has the form

$$(1.21) \quad \begin{aligned} \dot{A}_1 &= w_1, & \dot{A}_2 &= w_1 + w_2, & \dot{A}_3 &= w_1 - w_2 + w_3, \\ \dot{A}_4 &= -w_2, & \dot{A}_5 &= w_2 - 2w_3, \end{aligned}$$

where overdots indicate differentiation with respect to t . The rates w_i , by the law of mass action, may be expressed in terms of the concentration as follows:

$$(1.22) \quad w_1 = K_1 A_1 A_2, \quad w_2 = K_2 A_3 A_4, \quad w_3 = K_3 A_5^2.$$

The reactions are assumed to be isothermal and, therefore, we do not consider an equation for the temperature T , and we regard the reaction rate constants to be independent of T .

We determine the vectors σ , needed to construct the balance polyhedron. We note that in writing equation (1.7) it is sufficient to replace A_k in the scheme of

reactions by σ_k and the arrows by equal signs. For the reaction scheme (1.20), therefore, we obtain

$$\sigma_1 + \sigma_2 = \sigma_3, \quad \sigma_3 + \sigma_4 = \sigma_2 + \sigma_5, \quad 2\sigma_5 = \sigma_3.$$

This system has two linearly independent solutions: $\sigma^{(1)} = (1, 1, 2, 0, 1)$ and $\sigma^{(2)} = (0, 2, 2, 1, 1)$. Thus the balance polyhedron Π is given by the relations

$$(1.23) \quad A_1 + A_2 + 2A_3 + A_5 = a_1, \quad 2A_2 + 2A_3 + A_4 + A_5 = a_2,$$

$A_k \geq 0$ ($k = 1, \dots, 5$), where $a_1 > 0$, $a_2 > 0$. In order to find the stationary points of system (1.21), it is necessary to equate the rates (1.22) to zero and to take solutions lying in the balance polyhedron (1.23):

$$(1.24) \quad A_1 A_2 = 0, \quad A_3 A_4 = 0, \quad A_5 = 0.$$

We shall not enumerate all the possibilities existing here, but limit the discussion to the case in which $A_4 > 0$ at a stationary point. This assumption has a completely clear physical meaning: for the oxidation reaction of carbon bisulfide CS_2 considered here, it is assumed that oxygen O_2 is available in abundance and cannot be all used up. Thus we have the following stationary points:

$$A^{(1)} = (0, a_1, 0, a_2 - 2a_1, 0), \quad A^{(2)} = (a_1, 0, 0, a_2, 0),$$

where it is assumed that $a_2 > 2a_1$. Obviously, reactions (1.20) are reactions with an open graph and as $V(A)$ we can take the function

$$V = A_1 + A_2 + A_3 + 2A_4 + A_5,$$

so that the derivative along the trajectories of system (2.1) is equal to

$$\dot{V} = -(w_1 + w_2 + w_3).$$

Since $V(A^{(1)}) = 2a_2 - 3a_1 < V(A^{(2)}) = 2a_2 + a_1$, it follows that $A^{(1)}$ is an asymptotically stable point in Π , and $A^{(2)}$ is unstable. We can give this result concerning existence and stability of stationary points the following physical interpretation. At point $A^{(1)}$ the concentration of the initial substance $A_1 = CS_2$ is equal to zero, i.e., the substance is completely used up and the reaction can no longer continue. It is clear that with a small change of concentrations the system reverts to the same state indicating asymptotic stability of a stationary point. The second stationary point $A^{(2)}$ is of an entirely different nature. At this point concentrations of the active centers $A_2 = O$ and $A_3 = S$ are equal to zero, and, as is evident from the reaction scheme (1.20), the reaction cannot proceed. Small perturbations, i.e., the addition of a small amount to at least one of the active centers, lead to a development of the reaction since active centers will be formed later in the process of the reaction, and the reaction will continue so long as the initial substance CS_2 is not used up, i.e., the system arrives at the stationary state indicated above.

1.2. Waves. In the case of a spatially nonhomogeneous system it is necessary to take into account the distribution of concentrations and temperature over space,

and also of transport phenomena, namely, diffusion and heat transfer. In this regard, we consider the following system of partial differential equations:

$$(1.25) \quad \begin{aligned} \frac{\partial A}{\partial t} &= d\Delta A + \Gamma w(A, T), \\ \frac{\partial T}{\partial t} &= \varkappa\Delta T + (q, w(A, T)). \end{aligned}$$

Here A , T , Γ , and q have the same meaning as above, except that now the concentrations A and temperature T are functions not only of the time, but also spatial coordinates; d is the matrix of diffusion coefficients, assumed to be a diagonal matrix; \varkappa is the coefficient of heat conduction; Δ is the Laplace operator. System (1.25) is considered in the space (x_1, x_2, x_3) in an infinite three-dimensional cylinder, a cross-section of which is an arbitrary bounded domain with a smooth boundary. We assume that the x_1 -axis is directed along the cylinder axis. On the boundary of the cylinder the following conditions are specified:

$$(1.26) \quad \frac{\partial A}{\partial \nu} = 0, \quad \frac{\partial T}{\partial \nu} = 0,$$

where ν is the normal to the surface of the cylinder, i.e., we assume no transfer of mass and heat through the surface of the cylinder.

At infinity the following conditions are specified:

$$(1.27) \quad \begin{aligned} \lim_{x_1 \rightarrow \infty} A(x_1, x_2, x_3, t) &= A^+, & \lim_{x_1 \rightarrow \infty} T(x_1, x_2, x_3, t) &= T^+, \\ \lim_{x_1 \rightarrow -\infty} A(x_1, x_2, x_3, t) &= A^-, & \lim_{x_1 \rightarrow -\infty} T(x_1, x_2, x_3, t) &= T^-, \end{aligned}$$

where the values of A^\pm and T^\pm are assumed to be constant.

We shall consider planar waves and their existence and stability. With a loss of stability of planar waves, three-dimensional structures can arise as the result of bifurcations, as described in Part II. A planar wave is a solution of system (1.25) independent of x_2 and x_3 , and dependent only on the variable $x = x_1 - ct$, where c is a constant, namely, the wavespeed. Obviously, planar waves satisfy the following system of ordinary differential equations:

$$(1.28) \quad \begin{aligned} dA'' + cA' + \Gamma w(A, T) &= 0, \\ \varkappa T'' + cT' + (q, w(A, T)) &= 0, \end{aligned}$$

where “prime” indicates differentiation with respect to variable x . Conditions (1.26) are satisfied automatically, and (1.27) becomes

$$(1.29) \quad \begin{aligned} \lim_{x_1 \rightarrow \infty} A(x) &= A^+, & \lim_{x_1 \rightarrow \infty} T(x) &= T^+, \\ \lim_{x_1 \rightarrow -\infty} A(x) &= A^-, & \lim_{x_1 \rightarrow -\infty} T(x) &= T^-. \end{aligned}$$

These conditions are not independent: A^+ and A^- must belong to the same balance polyhedron, i.e., they must satisfy the equations

$$(1.30) \quad (\sigma^l, A^+ - A^-) = 0 \quad (l = 1, \dots, m - r),$$

where $\sigma^l = (\sigma_1^l, \dots, \sigma_m^l)$ are the same quantities as appeared in (1.9), so that we have the equations $\sigma^l \Gamma = 0$. To prove (1.30) it is sufficient to multiply the first

equation in (1.28) by σ^l and integrate along the axis. As was the case in (1.13), we obtain

$$(1.31) \quad T^+ - T^- = (\tau, A^+ - A^-).$$

Thus for a wave to exist it is necessary that conditions (1.30), (1.31) be satisfied. We shall assume that these conditions are satisfied. As is usual, we assume that points A^+ , T^+ and A^- , T^- are stationary points of the corresponding nondistributed system (1.5), (1.4), i.e.,

$$(1.32) \quad \Gamma w(A^+, T^+) = 0, \quad (q, w(A^+, T^+)) = 0,$$

$$(1.33) \quad \Gamma w(A^-, T^-) = 0, \quad (q, w(A^-, T^-)) = 0.$$

We assume also that the point A^-, T^- belongs to an asymptotically stable (closed) stationary face $\widehat{\Pi}^-$ of the balance polyhedron $\widehat{\Pi}$. In particular, this can be an isolated asymptotically stable stationary point.

The second stationary point A^+, T^+ can be of a different nature. We shall consider two cases, which we can refer to as the stationary state of thermal and kinetic nature. The first of these cases is realized for reactions with a strong dependence of the reaction rate on the temperature. At low temperature the reactions take place so slowly that, to a fairly good approximation, their rates can be assumed equal to zero:

$$(1.34) \quad \begin{aligned} K_i(T) &= 0 \text{ for } T \leq T^*, \\ K_i(T) &> 0 \text{ for } T > T^*, \end{aligned} \quad i = 1, \dots, n,$$

where T^* is a number between T^- and T^+ . Such an approach, namely, one involving a source cut-off, is typical for problems of combustion (see [Zel 5]). It is clear, by virtue of (1.3), that all the rates $w_i(A^+, T^+)$ are equal to zero and that equations (1.33) are valid.

In the second of the cases considered the source cut-off is not made and the stationary point is of a kinetic character. Typical examples for this case include cold flame, the Belousov-Zhabotinsky reaction, and a number of nonisothermal chain reaction processes with a weak temperature dependence of the reaction rate. Here the stationary point A^+, T^+ belongs to a (closed) stationary face $\widehat{\Pi}^+$ of the polyhedron $\widehat{\Pi}$, which can be both stable as well as unstable. In what follows, we shall assume that $\widehat{\Pi}^+$ and $\widehat{\Pi}^-$ have no points in common.

As an example, we can consider the case of reactions with on open graph. Here $\widehat{\Pi}^-$ can be defined as the face of balance polyhedron Π on which $V(A)$ attains a minimum. As was indicated above, this is an asymptotically stable stationary face. The second stationary face $\widehat{\Pi}^+$, if it exists and is isolated, is unstable. In the cold flame model of (1.20) presented above, there are low isolated stationary points: asymptotically stable and unstable. We present other examples below.

§2. Monotone systems

In this section we study wave solutions of kinetic systems which, by means of a linear change of variables of the form (1.11), can be reduced to monotone systems, considered in Chapters 3 and 5. The existence and stability of waves for systems of chemical kinetics will follow from results obtained in this chapter. Various kinetic systems encountered in applications will be considered.

2.1. Reduction to monotone systems. We consider the kinetic system (1.2) and in it make the substitution (1.11). For definiteness, we shall assume that the first r reactions in system (1.1) are linearly independent, which results in no loss of generality since the reactions can be renumbered. This means that the first r columns of matrix Γ (see (1.6)) are linearly independent. As the matrix P we can take the matrix consisting of the first r columns of matrix Γ . Then the new variables u_i ($i = 1, \dots, r$) are introduced by the equations

$$(2.1) \quad A_j = \sum_{i=1}^r \gamma_{ij} u_i + A_j^+ \quad (j = 1, \dots, m),$$

where the boundary condition is taken as the fixed point A^+ . Since all the columns of matrix Γ , beginning with the $(r+1)$ st, depend linearly on the first r columns, we then have the equations

$$(2.2) \quad \gamma_{kj} = \sum_{i=1}^r \lambda_{ki} \gamma_{ij} \quad (k = r+1, \dots, n),$$

where λ_{ki} are certain numbers. Substituting these expressions into the system of equations (1.2), we obtain

$$(2.3) \quad \frac{dA_j}{dt} = \sum_{i=1}^r \gamma_{ij} \left(w_i + \sum_{k=r+1}^n \lambda_{ki} w_k \right) \quad (j = 1, \dots, m).$$

We can now go over to the new variables u_j in accordance with formulas (2.1):

$$\sum_{i=1}^r \gamma_{ij} \frac{du_i}{dt} = \sum_{i=1}^r \gamma_{ij} \left(w_i + \sum_{k=r+1}^n \lambda_{ki} w_k \right) \quad (j = 1, \dots, m).$$

Taking into account that the rank of matrix Γ is equal to r , it follows that

$$(2.4) \quad \frac{du_i}{dt} = w_i + \sum_{k=r+1}^n \lambda_{ki} w_k \quad (i = 1, \dots, r).$$

This system of equations is equivalent to system (1.2). It is assumed here that in equation (1.3) the reaction rate A_j has been replaced by its expression from (2.1). In the nonisothermal case it is necessary to substitute the temperature into the expression (1.3) for the rates using equation (1.15). Recalling that as the matrix P we have taken the first r columns of matrix Γ , we have, taking into account (1.13),

$$(2.5) \quad T = \sum_{i=1}^r q_i u_i + T^+.$$

After making the indicated substitutions, we denote the right-hand side of (2.4) by $F_i(u)$:

$$(2.6) \quad F_i(u) = w_i + \sum_{k=r+1}^n \lambda_{ki} w_k \quad (i = 1, \dots, r).$$

By definition (see Chapter 3), the condition for monotonicity of the system amounts

to the validity of the following inequalities:

$$(2.7) \quad \frac{\partial F_i(u)}{\partial u_j} \geq 0 \quad (i, j = 1, \dots, r; \quad i \neq j).$$

We need to obtain these conditions in explicit form using (1.3), whereby throughout this section we assume that $g_i(A) = 1$ and that

$$(2.8) \quad K'_i(T) \geq 0 \quad (i = 1, \dots, n).$$

We remark that this latter condition is satisfied, in particular, for the Arrhenius temperature dependence of the reaction rate,

$$(2.9) \quad K_i(T) = K_i^0 e^{-E_i/RT},$$

where K_i^0 , E_i , and R are constants; E_i is the activation energy; R is the universal gas constant.

A direct calculation yields

$$(2.10) \quad \frac{\partial w_i}{\partial u_j} = w_i \left[\sum_{k=1}^m \frac{\nu_{ik} \gamma_{jk}}{A_j} + \frac{K'_i(T)}{K_i(T)} q_j \right].$$

In particular, in the case of Arrhenius temperature dependence,

$$(2.11) \quad \frac{\partial w_i}{\partial u_j} = w_i \left[\sum_{k=1}^m \frac{\nu_{ik} \gamma_{jk}}{A_j} + \frac{E_i}{RT^2} q_j \right].$$

We return now to system (2.4). We begin with the case in which reactions (1.1) are linearly independent ($r = n$). System (2.4) then has the form

$$(2.12) \quad \frac{du_i}{dt} = w_i \quad (i = 1, \dots, n)$$

and sufficient conditions for its monotonicity can be written, by virtue of (2.10), in the following way:

$$(2.13) \quad \nu_{ik} \gamma_{jk} \geq 0, \quad q_j \geq 0 \quad (i, j = 1, \dots, n; \quad k = 1, \dots, m; \quad i \neq j).$$

These conditions are considered in greater detail in the following section.

We pass over now to the general case of system (2.4). From (2.6) and (2.10) we obtain

$$(2.14) \quad \frac{\partial F_i}{\partial u_j} = w_i \left[\sum_{k=1}^m \frac{\nu_{ik} \gamma_{jk}}{A_k} + \frac{K'_i(T)}{K_i(T)} q_j \right] + \sum_{l=r+1}^n \lambda_{li} w_l \left[\sum_{k=1}^m \frac{\nu_{lk} \gamma_{jk}}{A_k} + \frac{K'_i(T)}{K_i(T)} q_j \right].$$

Sufficient conditions for monotonicity take the form

$$(2.15) \quad \nu_{ik} \gamma_{jk} \geq 0, \quad \lambda_{li} \nu_{lk} \gamma_{jk} \geq 0, \quad q_j \geq 0, \quad \lambda_{li} q_j \geq 0$$

for all $i, j = 1, \dots, r$, $i \neq j$; $l = r + 1, \dots, n$; $k = 1, \dots, m$.

Conditions described in this form are inconvenient for application. In the following section we supply a simpler interpretation for them.

2.2. Monotonicity conditions. To obtain a form of the monotonicity conditions (2.15), more suitable for application, we consider the linear forms γ_i , corresponding to reactions (see (1.12)), and ν_i (corresponding to rates (see (1.3)):

$$(2.16) \quad \gamma_i(A) = \gamma_{i1}A_1 + \cdots + \gamma_{im}A_m \quad (i = 1, \dots, n)$$

$$(2.17) \quad \nu_i(A) = \nu_{i1}A_1 + \cdots + \nu_{im}A_m.$$

Only signs of the coefficients of the A_k are of interest to us here. Therefore, instead of (2.17), we can consider the form

$$(2.18) \quad \alpha_i(A) = \alpha_{i1}A_1 + \cdots + \alpha_{im}A_m,$$

connected with the left-hand sides of reactions (1.1). Such an approach to forms is more suitable since many of the coefficients α_{ij} , γ_{ij} are equal to zero. For example, for the reactions (1.20), we have

$$(2.19) \quad \begin{aligned} \alpha_1 &= A_1 + A_2, & \alpha_2 &= A_3 + A_4, & \alpha_3 &= 2A_5, \\ \gamma_1 &= A_3 - A_1 - A_2, & \gamma_2 &= A_2 + A_5 - A_3 - A_4, & \gamma_3 &= A_3 - 2A_5. \end{aligned}$$

We begin with the isothermal case, i.e., we assume that $q_i = 0$ ($i = 1, \dots, n$).

First let us give an interpretation of the first of inequalities (2.15). We compare forms $\alpha_i(A)$ with $\gamma_j(A)$ ($i \neq j$). We say that an element A_k is an element common to these forms if it appears in both of these forms with nonzero coefficients. For example, in (2.19) α_1 and γ_2 have the common element A_2 ; α_1 and γ_3 have no elements in common.

The first of the conditions (2.15) consists in the following.

CONDITION 1. In the forms α_i and γ_j ($i, j = 1, \dots, r$; $i \neq j$), all elements in common, if they exist, must be of the same sign.

It is readily verified that this condition is satisfied for the forms (2.19). We note that the forms α_1 and γ_1 have elements A_1 and A_2 in common, but with opposite signs; however, they must not be compared since the comparison is to be made for $i \neq j$.

We consider yet another example, also of interest, since it represents a model of a heterogeneous catalytic reaction for which the condition for existence and stability of an isothermal wave is satisfied (see §3). This model was studied by V. I. Bykov [Byk 1] from the point of view of a multiplicity of stationary states of a nondistributed system. The scheme of the reactions has the form

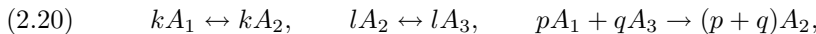

where k , l , p , and q are positive integers.

Taking into account reverse reactions, we find that this scheme contains five reactions, which we renumber so that the first three reactions will be direct. In accordance with this, we have

$$\begin{aligned} \alpha_1 &= kA_1, & \alpha_2 &= lA_2, & \alpha_3 &= pA_1 + qA_3, & \alpha_4 &= kA_2, & \alpha_5 &= lA_3, \\ \gamma_1 &= k(A_2 - A_1), & \gamma_2 &= l(A_3 - A_2), & \gamma_3 &= (p+q)A_2 - pA_1 - qA_3, \\ \gamma_4 &= k(A_1 - A_2), & \gamma_5 &= l(A_2 - A_3). \end{aligned}$$

The first two reactions are linearly independent; the remaining ones depend on them linearly:

$$(2.21) \quad \gamma_3 = \frac{p}{k}\gamma_1 - \frac{q}{l}\gamma_2, \quad \gamma_4 = -\gamma_1, \quad \gamma_5 = -\gamma_2.$$

Verification of the first of inequalities (2.15) consists in comparing α_1 with γ_2 and α_2 with γ_1 . The condition is obviously satisfied.

Consider now the second of inequalities (2.15). The numbers λ_{li} appearing here express, by virtue of (2.2), the linear dependence of the forms γ_i :

$$(2.22) \quad \gamma_l = \sum_{i=1}^r \lambda_{li} \gamma_i \quad (l = r+1, \dots, n).$$

It is convenient to introduce the form

$$\overset{i}{\alpha}_l = \text{sgn } \lambda_{li} \cdot \alpha_l$$

and take no account of zero forms. The second of the conditions (2.15) is then formulated in a manner completely similar to the first.

CONDITION 2. In forms $\overset{i}{\alpha}_l$ and γ_j ($i, j = 1, \dots, r$; $i \neq j$; $l = r+1, \dots, n$) all common elements, if any, must be of the same sign.

For example, for reactions (2.20) we have the forms $\overset{1}{\alpha}_3 = \alpha_3$, $\overset{1}{\alpha}_4 = -\alpha_4$. These must be compared with γ_2 . Next, $\overset{2}{\alpha}_3 = -\alpha_3$, $\overset{2}{\alpha}_5 = -\alpha_5$ are compared with γ_1 . We see that common elements, where they are present, appear with identical signs. Consequently, the monotonicity conditions are satisfied for reactions (2.20).

We point out two classes of reactions for which the conditions of monotonicity can be formulated most simply. The first of these is the class of linearly independent reactions. In this case, it is obviously necessary to verify only Condition 1. It is clear that if each substance A_k is consumed (i.e., is found on the left side) in no more than a single reaction, Condition 1 is satisfied. In other words, a sufficient condition for monotonicity for linearly independent reactions is the absence of parallel stages. Thus, for example, reactions (1.20) are linearly independent and in them there are no parallel stages.

The second class of reactions we consider are reversible reactions in which the direct reactions are linearly independent. It is convenient to introduce, along with α_i and γ_i , the additional form

$$\beta_i(A) = \beta_{i1}A_1 + \dots + \beta_{im}A_m$$

and to write reactions in the following form:

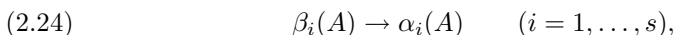
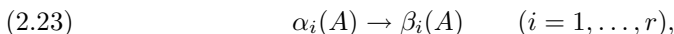

where $s \leq r$. Condition 1 must be satisfied for the reactions (2.23); Condition 2 must be satisfied for reactions (2.24). In order to make the notation consistent with that introduced earlier, we set $\alpha_{i+r} = \beta_i$ ($i = 1, \dots, s$), $\gamma_{i+r} = -\gamma_i$. From this we have $\overset{i}{\alpha}_{i+r} = -\beta_i$. Condition 2 now looks as follows: in the forms $-\beta_i$ and γ_j ($i = 1, \dots, s$; $j = 1, \dots, r$) common elements, if they are present, must appear with identical signs. Thus we can state the following sufficient condition

for monotonicity for the reactions (2.23), (2.24): reactions (2.23) must not have parallel stages; the substances that appear on the left side of the i th reaction of (2.24) ($i = 1, \dots, s$) must not appear in β_j ($j = 1, \dots, r; i \neq j$). In particular, when $r = s$, reversible reactions must not have parallel stages. For example, in reactions (1.20) we can include a reverse stage for the second reaction without violation monotonicity conditions, but this cannot be done for the first reaction.

REMARK. In the case of linearly independent reactions the requirement that parallel stages be absent is sufficient for Condition 1 to be satisfied, but it is not necessary. It is equivalent to Condition 1 only when the substances on the right and left sides of the reactions are completely different. In the contrary case, we can allow the presence of parallel stages. For example, for a system of auto-catalytic reactions



Condition 1 is satisfied.

We have considered the isothermal case. For nonisothermal processes additional conditions on thermal effects of the reactions are appended. If the reactions are linearly independent, it follows from (2.13) that, in addition to Condition 1, it is sufficient to require that the thermal effects be nonnegative.

In the general case, presence of the condition $\lambda_i q_j \geq 0$ can imply that certain thermal effects must be equal to zero. However, this result can be connected only with the method of reduction to monotone systems. We turn our attention to this in greater detail.

All the conditions for reducibility to monotone systems, formulated in this section, were obtained on the assumption that, as the matrix P appearing in (1.11), the first r columns of matrix Γ were used. However, a choice of this kind for matrix P is not mandatory. As a consequence of what was said in §1,

$$(2.25) \quad P = \Gamma M,$$

where as M we can take an arbitrary $m \times n$ matrix such that P is of rank r . The choice of matrix M can be important for the possibility of a reduction to monotone systems: as is easily seen from examples, the choice of linearly independent columns of matrix Γ , that are taken as P , is also important. Therefore, the class of systems, reducible to monotone systems, can be broadened by including matrix M in the monotonicity condition and then selecting it. It will be shown in the following chapter that for reactions with an open graph, and not only for linearly independent reactions, the matrix P can be chosen so that the resulting monotonicity conditions are satisfied for arbitrary nonnegative thermal effects.

We show now how the reduction to a monotone system using (2.25) may be carried out. From (1.11) and (1.5) we have

$$P \frac{du}{dt} = \Gamma w.$$

Let N be an $r \times n$ matrix such that

$$(2.26) \quad \Gamma = PN.$$

It is obvious that matrix N may be determined uniquely. Thus

$$(2.27) \quad \frac{du}{dt} = F(u),$$

where

$$(2.28) \quad F(u) = Nw(Pu + A^+, \tau Pu + T^+).$$

It is easy to see that system (2.27) is equivalent to (1.5), (1.4). We require matrix (2.28) to satisfy condition (2.7).

One of the possibilities for realizing such an approach consists in adjoining to the given system of reactions (1.1) new reactions that are linear combinations of the given reactions, selecting linearly independent reactions in the broadened system of reactions, and verifying Conditions 1 and 2. In the system (2.27), so obtained, rates corresponding to the introduced reactions are discarded.

As an example, we consider the system of reactions

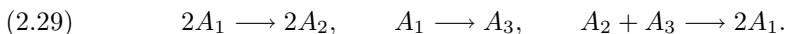

The first two reactions are linearly independent. The third one linearly depends on them. The first two reactions contain parallel stages and do not satisfy Condition 1. To this system we adjoin the reaction $A_3 \rightarrow A_1$ and we select it and the first reaction as linearly independent reactions in terms of which the rest are expressed. It is readily verified that Conditions 1 and 2 are satisfied.

§3. Existence and stability of waves

In this section we prove existence and stability of waves for kinetic systems reducible to monotone systems. As a preliminary, for a system of equations (1.28) describing traveling waves, assuming equality of transport coefficients, we perform the same kind of reduction to monotone systems that was done in the preceding section for a nondisturbed system.

3.1. Passage to new variables. From the dependent variables A and T we go over to new variables u in accordance with equations (1.11), (1.15):

$$(3.1) \quad A(x) = Pu(x) + A^+, \quad T(x) = \tau Pu(x) + T^+,$$

where A^+ , T^+ are specified from conditions (1.29) and matrix P is given by equation (2.25). Taking equation (2.26) into account and regarding d to be a scalar matrix, we obtain

$$(3.2) \quad P(du'' + cu' + Nw) = 0.$$

Since P has rank r , it then follows from this that

$$(3.3) \quad du'' + cu' + F(u) = 0,$$

where

$$(3.4) \quad F(u) = Nw(Pu + A^+, \tau Pu + T^+).$$

Conditions for u at infinity are obtained from (1.29) and (3.1):

$$(3.5) \quad \lim_{x \rightarrow \infty} u(x) = u^+, \quad \lim_{x \rightarrow -\infty} u(x) = u^-,$$

where $u^+ = 0$ and u^- is obtained from the equations

$$(3.6) \quad Pu^- = A^- - A^+.$$

We note, by virtue of (1.30), that this system of equations has a solution.

For $\varkappa = d$, it is clear, conversely, that if $u(x)$ is a solution of problem (3.3), (3.5), then functions $A(x)$, $T(x)$, specified by equations (3.1), are solutions of problem (1.28), (1.29). Indeed, multiplying (3.3) by P , we obtain (3.2), and, consequently, A is a solution of the first of equations (1.28). Next, we multiply (3.2) scalarly by vector τ and take note of (1.13). We find that T satisfies the second of equations (1.28). From (3.5), (3.6), and (1.31) it follows that conditions (1.29) are satisfied.

Thus we have obtained problem (3.3), (3.5), a problem equivalent to the problem (1.28), (1.29).

3.2. Existence and stability of waves. To prove the existence of solutions of problem (1.28), (1.29) it would be sufficient to use Theorem 4.2 of Chapter 3 for the monotone system (3.3). However, this cannot be done directly for the following reason. In the proof of the theorem indicated, it was assumed that the vector-valued function $F(u)$ is given in the interval $[u^+, u^-]$ and satisfies there the monotonicity condition. In the case considered here, this, generally speaking, is not so. Function $F(x)$ is given in the balance polyhedron Π_u , which may not be an interval. It will therefore be necessary for us to supplement the proof of the theorem in connection with this case. Actually, this means that we shall need to verify the nonnegativeness of the concentrations $A(x)$ in the course of the proof.

We introduce the quantity ω^* , defined by equations (4.4) and (4.5) of Chapter 3. It is assumed here that K is constricted owing to the addition of the condition $P\rho(x) + A^+ \geq 0$, i.e., that $\rho(x) \in \Pi_u$.

The existence theorem for waves may be stated as follows.

THEOREM 3.1. *In the balance polyhedron Π_u let the vector-valued function $F(u)$, given by equation (3.4), satisfy the monotonicity condition*

$$\frac{\partial F_i(u)}{\partial u_j} \geq 0 \quad (i, j = 1, \dots, r; \quad i \neq j)$$

and vanish only at the points u^+ and u^- . Assume, further, that a vector $p \geq 0$, $p \neq 0$, exists such that

$$(3.7) \quad F(u^+ + sp) \geq 0 \quad \text{for } 0 < s \leq s_0,$$

where s_0 is a positive number. Then, assuming that $u^- > u^+$, there exists, for all $c \geq \omega^*$, a monotonically decreasing solution $u(x)$ of system (3.3), satisfying conditions (3.5), such that the functions $A(x)$, specified by equations (3.1), are nonnegative. When $c < \omega^*$, such solutions do not exist.

PROOF. We shall not repeat in full the proof of Theorem 4.2 of Chapter 3, but shall supply only the necessary additions. We assume, first, that $c > \omega^*$. Then, according to the definition of the number ω^* , there exists $\rho(x) \in K$, such that

$$(3.8) \quad d\rho''(x) + c\rho'(x) + F(\rho(x)) < 0$$

for all x . We consider a boundary problem for system (3.3) on the semi-axis $x < b$ with the condition (4.9) of Chapter 3:

$$(3.9) \quad u(b) = sp + u^+.$$

We show that there exists a monotonically nonincreasing solution of this problem

$u(x) \in \Pi_u$. To do this, we consider the problem

$$(3.10) \quad \begin{aligned} \frac{\partial v}{\partial t} &= d \frac{\partial^2 v}{\partial x^2} + c \frac{\partial v}{\partial x} + F(v), & t > 0, \quad x < b, \\ v(b, t) &= u(b), & v(x, 0) &= u(b). \end{aligned}$$

Let

$$(3.11) \quad A(x, t) = Pv(x, t) + A^+, \quad T(x, t) = \tau Pv(x, t) + T^+.$$

It is clear that $A(x, t)$ is a solution of the following problem:

$$(3.12) \quad \frac{\partial A}{\partial t} = d \frac{\partial^2 A}{\partial x^2} + c \frac{\partial A}{\partial x} + \Gamma w(A, T), \quad t > 0, \quad x < b,$$

$$(3.13) \quad A(b, t) = Pu(b) + A^+, \quad A(x, 0) = Pu(b) + A^+.$$

By assumption, $u(b)$ defined by equation (3.9) belongs to the polyhedron Π_u . Consequently, $A(b, t) \geq 0$, $A(x, 0) \geq 0$. It is known (see Chapter 5) that the solution of problem (3.12), (3.13) is nonnegative. This means that solution $v(x, t)$ of problem (3.10), for all $x < b$ and $t > 0$, belongs to the balance polyhedron Π_u . Since $v = u(b)$ is a lower function for system (3.10), the solution $v(x, t)$ of this system is monotonically nondecreasing with respect to t . On the other hand, $\rho(b) > u(b)$ on the basis of (4.8) of Chapter 3. If we consider function $z(x, t) = \rho(x) - v(x, t)$, where $v(x, t)$ is the solution of (3.12), (3.13), then, by virtue of (3.8), z will satisfy the equation

$$(3.14) \quad \frac{\partial z}{\partial t} = d \frac{\partial^2 z}{\partial x^2} + c \frac{\partial z}{\partial x} + B(x, t)z,$$

where

$$B(x, t) = \int_0^1 F'(s\rho(x) + (1-s)v(x, t)) ds,$$

F' is the matrix of partial derivatives of the vector-valued function $F(u)$. Since $\rho(x)$ and $v(x, t)$ belong to Π_u , we have that $s\rho(x) + (1-s)v(x, t)$ also belongs to this polyhedron, and, therefore, $B(x, t)$ has nonnegative off-diagonal elements. It follows from (3.14) that $z(x, t) \geq 0$, i.e., $v(x, t) \leq \rho(x)$. Thus the limit of $v(x, t)$ as $t \rightarrow \infty$ exists; we denote it by $u(x)$. It is obvious that $u(x) \leq \rho(x)$. Moreover, $u(x) \in \Pi_u$ for $x \leq b$. It may be proved, exactly as was done in Theorem 4.2 of Chapter 3, that $u(x)$ is a monotonically nonincreasing solution of problem (3.9), (3.10), and all further construction proceeds in the same way. This completes the proof of the theorem. \square

REMARKS. 1. In the theorem it was proved that the solution $u(x)$ of problem (3.3), (3.5) belongs to the balance polyhedron Π_u . It may be readily verified that the set Π_u can be replaced by any other positively invariant set. Let us formulate this more precisely. We first define what is meant in the present case by positive invariance. We say that a set $G \subset \mathbb{R}^2$ is positively invariant if it is closed, convex, and if the solution $v(x, t)$ of problem (3.10) belongs to G for all $x < b$, $t > 0$, provided that the boundary and initial condition belongs to G .

In the statement of the theorem we replace Π_u throughout by G . This means that in the definition of ω^* we assume that the class K is the class of monotonically decreasing functions $\rho(x) \in C^2$, satisfying the conditions $\lim \rho(x) = u^\pm$ as $x \rightarrow \pm\infty$ and $\rho(x) \in G$ for all x . The theorem can be stated in the following way. Suppose

$F(u)$ satisfies the monotonicity condition in G and vanishes only at two points u^+ and u^- . Suppose, further, that a vector $p \geq 0$, $p \neq 0$, exists such that $u^+ + sp \in G$ and that (3.7) holds. Then for all $c \geq \omega^*$ there exists a monotonically decreasing solution $u(x)$ of problem (3.3), (3.5) such that $u(x) \in G$ for all x . When $c < \omega^*$, such solutions do not exist. The proof is similar to the previous proof.

Explicit algebraic conditions for positive invariance are known (see [Red 1] and references therein). Our interest centers on the case in which set G is obtained as the intersection of polyhedron Π_u with domains of the form $s(u) \leq 0$, where $s(u)$ are twice continuously differentiable functions satisfying a convexity condition and where the surface $s(u) = 0$ does not contain the point u^- . The condition of positive invariance consists in the circumstance that vector $F(u)$ is directed towards the interior of domain G at points of these surfaces.

2. In the theorem it was assumed that the vector-valued function $F(u)$ vanishes only at the two points u^+ and u^- in the balance polyhedron Π_u . In various problems of chemical kinetics cases are encountered in which the stationary points u^+ and (or) u^- are not isolated points in Π_u . To prove the existence of waves in this case use can be made of the following approach. We select a pair of stationary points of interest to us, u^+ and u^- , which we take as conditions at infinity. We construct, if possible, a positively invariant set G , as defined in the preceding remark, such that $G \subset \Pi_u$ and such that only these two stationary points are contained in G . Based on what was said in Remark 1, we obtain the existence of waves with the given values u^+ and u^- at the infinities. Illustrations of this approach through model problems will be presented in §4.

3. A theorem for the existence of waves was proved in the monostable case. A similar result holds for the bistable case. To see this, we need to verify that in the homotopy process used in the Leray-Schauder method, nonnegativeness of concentrations is preserved. We shall not do this here: detailed proofs in an analogous case are provided in the following chapter (for problems of combustion).

We proceed now to the problem concerning stability of waves. We can use the results from §4 of Chapter 5 concerning stability of waves for monotone systems. In this connection, for systems of equations of chemical kinetics, reducible to monotone systems, results concerning stability are obtained in the variables u , introduced in §3.1. In these variables, based on Theorem 4.1 of Chapter 5, stability of waves occurs (if, of course, conditions for this theorem are satisfied). We can also state results concerning stability of waves in the initial variables, which are the concentrations A and the temperature T . This question is also pursued in more detail in the following chapter for combustion problems.

3.3. Remarks concerning nonmonotone systems.¹ For systems of equations of chemical kinetics which can be reduced to monotone systems, traveling waves, as was shown above, exist and are stable. It can be expected that existence of waves occurs even for a more general class of systems. Above all, this concerns systems of reactions with an open graph, which, as already mentioned, encompass a very broad class of nonreversible reactions. In the bistable case this can be proved by the Leray-Schauder method in the same way it is proved in the following chapter for problems of combustion. We remark that in that chapter a system of equations

¹The presentation in this section is of a descriptive nature and precise statements are not supplied.

of chemical kinetics is considered for the case in which a cut-off of the source may be done. No other characteristics of combustion problems is employed.

In the monostable case application of this method is limited, first of all, to the construction of a rotation of the vector field, which was carried out in Chapter 2 for the bistable case. Nevertheless, there is every reason to assume that this homotopic invariant can also be constructed for the monostable case. Actually, if we go over to weighted spaces, selected in an appropriate manner, the monostable case can then be reduced to the bistable case. It is true that here there appears an explicit dependence on x in the operator, which, however, must not hinder carrying-out the constructions of Chapter 2.

There can be no stability of waves for systems of equations not reducible to monotone systems, not even in the simplest cases. Simple examples show that if the transport coefficients are distinct, it is then possible that a planar wave will lose stability and that various oscillatory modes will appear. In this connection, it is of interest to consider systems homotopic to monotone systems. We mean systems of the form (1.25) which can be obtained from the monotone systems, considered above, by a continuous change in the coefficients of diffusion (here d can already be considered not as a number, but a matrix), thermal conductivity, and the kinetic constants. It is assumed here that the stationary points of a kinetic system, which determine the conditions at infinity, vary continuously and do not change the nature of the stability. We assume that a change in the indicated physical quantities takes place along a curve, described with the aid of some parameter τ , so that for $\tau = 0$ the system is monotone. For $\tau = 0$, a planar wave is stable, and the eigenvalues of the operator, obtained by linearization of the right-hand side of (1.25) about a planar wave, lie in the left half-plane. This was proved above in the one-dimensional case. Similarly, this may also be proved for the multi-dimensional case upon expanding with respect to the eigenfunctions of the Laplace operator for the transverse variables.

We shall keep track of a planar wave for motion with respect to parameter τ , remaining within the scope of systems for which existence of a wave is known (for example, where a priori estimates are available and the Leray-Schauder method can be applied). For motion with respect to a parameter, the eigenvalue with maximum real part can land on the imaginary axis and intersect it. Bifurcations, described in Part II, will then take place.

§4. Branching chain reactions

As previously mentioned, the propagation of waves in chemical kinetics can have not only a thermal nature, as, for example, waves of combustion, but also a kinetic character. One of the most interesting classes of reactions for which such waves are possible is the class of branching chain reactions. In this section we consider conditions for the existence and stability of branching chain flames, both isothermal as well as nonisothermal.

4.1. Branching chain processes with kinetics of a general form. We consider the system of reactions (1.1). We divide all substances A_k ($k = 1, \dots, m$) taking part in these reactions into two groups. In the first group are the initial substances, which we denote by A_1, \dots, A_s ($s < m$). These are substances which appear on the left sides of reactions and do not appear on the right sides; they are substances which are only used up but not produced. In the second group are the

intermediate substances, which we denote by R_1, \dots, R_p , so that $A_{s+j} = R_j$ ($j = 1, \dots, p$; $s + p = m$). In the reaction process these substances are consumed and produced, i.e., they appear on both the left and right sides of reactions. Final products, i.e., substances appearing only on the right sides of reactions, may not be taken into account in our discussions.

We say that a system of reactions (1.1) describes a branching chain process if there exist nonnegative numbers $\lambda_1, \dots, \lambda_p$ such that the linear combination of concentrations

$$(4.1) \quad U(R) = \sum_{j=1}^p \lambda_j R_j$$

increases with respect to the time during the reaction process.

It is obvious that among the numbers λ_j there must be positive numbers (otherwise the sum (4.1) could not increase). Substances R_j that appear with nonzero coefficients λ_j are called active centers, due to which branching of a chain proceeds.

By the increase of $U(R)$ with time during the reaction process we mean that

$$(4.2) \quad \frac{dU}{dt} = \sum_{j=1}^p \lambda_j \frac{dR_j}{dt} = \sum_{j=1}^p \lambda_j \sum_{i=1}^n \gamma_{i,j+s} w_i \geq 0,$$

but not identically equal to zero. Here we have used equation (1.2) for the intermediate substances:

$$(4.3) \quad \frac{dR_j}{dt} = \sum_{i=1}^n \gamma_{i,j+s} w_i.$$

Obviously, the following inequality is a sufficient condition for the satisfaction of inequality (4.2):

$$(4.4) \quad \sum_{j=1}^p \lambda_j \gamma_{i,j+s} \geq 0 \quad (i = 1, \dots, n);$$

here at least one of these inequalities is strict. This condition can also be written in the matrix form

$$(4.5) \quad \lambda \hat{\Gamma} \geq 0,$$

where $\lambda = (\lambda_1, \dots, \lambda_p)$; $\hat{\Gamma}$ is the matrix formed from the last p rows of matrix Γ .

Inequalities (4.4) have the following physical interpretation: the number of active centers is maintained over a part of the reactions (1.1) (such reactions are called chain continuation reactions), but over the remaining part of the reactions it increases (such reactions are called branching reactions).

Since our concern is the study of waves joining various stationary points of a kinetic system, we shall be interested in the question concerning conditions for nonuniqueness of stationary points and their stability. Before formulating these conditions, we recall that linear dependence or independence of substances is to be understood as linear dependence or independence of the rows of matrix Γ .

CONDITION 1. There exists a set of linear independent intermediate substances such that

- 1) all active centers taking part in the branching of a chain are contained in this set;
- 2) in each reaction at least one of these intermediate substances is used up.

In particular, this condition means that reactions initiating a chain, i.e., reactions on whose left sides only initial substances appear, are absent. Such reactions are usually excluded in the study of chain flames.

Let us renumber the intermediate substances R_j so that the set in Condition 1 consists of the substances R_1, \dots, R_l ($l \leq p$).

As in §1.1, we consider a balance polyhedron Π , which is defined by equations (1.9) and inequalities $A_k \geq 0$ ($k = 1, \dots, m$). It is natural to consider nondegenerate balance polyhedra, i.e., polyhedra containing interior points: points in which all concentrations A_k are positive.

PROPOSITION 4.1. *If Condition 1 is satisfied, there then exists a nondegenerate balance polyhedron Π such that the equations*

$$(4.6) \quad R_1 = 0, \dots, R_l = 0$$

specify a stationary face of this polyhedron. This face is nonattracting, i.e., semi-trajectories, departing from an arbitrary interior point of polyhedron Π , cannot strike the face (4.6) as $t \rightarrow \infty$.

PROOF. Let r be the rank of matrix Γ . Then there exist r linearly independent substances on which the remaining $m - r$ substances depend linearly. We select r linearly independent substances such that all the substances R_1, \dots, R_l are contained among them; this can be done by virtue of the assumption concerning their linear independence. We denote all the linearly dependent substances by A_1, \dots, A_q ($q = m - r$), and the indicated set of linearly independent substances by A_{q+1}, \dots, A_m . We then have equations

$$(4.7) \quad A_j = \sum_{k=1}^r \tau_{jk} A_{q+k} + a_j \quad (j = 1, \dots, q),$$

where τ_{jk} and a_j are certain numbers. To specify the balance polyhedron Π , it is sufficient to prescribe the quantities a_j ($j = 1, \dots, q$). We do this by specifying some point $A = (A_1^0, \dots, A_m^0)$ of the balance polyhedron in the following way. We set $R_j = 0$ ($j = 1, \dots, l$). We take all the remaining independent concentrations to be nonnegative and all the dependent ones to be positive.

It is easy to see that the balance polyhedron so constructed has interior points and, even more, interior points lying arbitrarily close to the face (4.6). Indeed, we consider a point for which all concentrations, which are equal to zero at point A^0 , are given by small positive numbers, all remaining independent concentrations being left unchanged, while the dependent ones are calculated from (4.7). Moreover, the concentrations A_j ($j = 1, \dots, q$) remain positive since the change in the independent concentrations is small.

By virtue of Condition 1, face (4.6) is stationary since on it all reaction rates vanish. It remains to show that it is nonattracting. This follows from the fact that function $U(R)$ vanishes on face (4.6), is positive at an arbitrary interior point of polyhedron Π , and increases along any solution. The proposition is thereby established. \square

And so we see that when Condition 1 is satisfied, the balance polyhedron has a stationary face which is nonattracting. Furthermore, in many cases there also exist attracting stationary faces or, in particular, asymptotically stable stationary points. We present two broad classes of reactions for which this situation obtains.

The first class is a class of reactions with an open graph (see §1.1). In this case we have the Lyapunov function (1.18). As we did above, we assume that this function is bounded from below in the balance polyhedron Π . As was pointed out in §1.1, the set of points on which this function attains a minimum is asymptotically stable.

The second class of reactions for which attracting stationary faces are possible are those for which some part of the reactions forms reactions with an open graph, while the remaining part consists of reversible stages. In studying this class of reactions use is made of the well-known fact (see, for example, [Vol 9]) that for reversible reactions the point of detailed equilibrium is asymptotically stable.

Thus, in the classes of reactions indicated, there exist stationary points of two types, and a question arises concerning the existence of waves joining these points. We consider this in more detail for models and examples presented in the following sections.

4.2. Scalar equations. Scalar equation models have been fairly well studied and are presented here for completeness of exposition. We begin with the reaction



(Here, and in what follows, letters above arrows denote reaction rate constants.) The balance equation has the form

$$(4.9) \quad A + R = a,$$

where a is some number. In (2.1) we make the substitution

$$R = u, \quad A = a - u.$$

We arrive at the traveling wave equation

$$(4.10) \quad u'' + cu' + f(u) = 0,$$

where $f(u) = ku(a - u)$, with the following conditions at the infinities:

$$(4.11) \quad u^+ = 0, \quad u^- = a.$$

This equation has been well studied. A detailed study of it appears in [Kolm 1], wherein it is shown that a wave exists for speeds $c \geq 2(f'(0))^{1/2}$, and also approach to a wave with minimal speed. Later on these results were developed by various authors (see Chapter 1).

As a second example, we consider the reaction



which, together with reaction (4.8), can be regarded as the simplest model of an auto-catalytic chain reaction (see [Zel 5]). As above, we arrive at equation (4.10) with $f(u) = ku^2(1 - u)$. In contrast with the preceding case, $f'(0) = 0$ and, therefore, the minimal wavespeed satisfies the inequality $c > 2(f'(0))^{1/2}$, and we have uniform approach to a wave with minimal speed, and not only approach in form and speed as in the preceding case.

Reaction (4.12) is sometimes considered jointly with the reaction



(loss of an active center). Then, assuming constant k_0 to be small, we can consider the balance equation (4.9) as satisfied approximately (see [Zel 5]), and the wave propagation equation takes the form (4.10) with $f(u) = ku^2(a - u) - k_0u$. Unlike the preceding cases, the equation $f(u) = 0$ has three solutions, of which the first and the last determine the stable points of the kinetic equation, while the middle one determines an unstable point. We take the stable points to be u^+ and u^- , and, therefore, the wave described by equation (4.10) exists, is unique, and is stable.

Exact solutions are obtained in all considered cases (see [Mas 1] and [Zel 5]).

If heat generation is not neglected, the initial system of diffusion equations (for substances A and R) must be augmented by the heat conduction equation. In case the transport coefficients are equal, the system of these three equations may be reduced to the equation (4.10) (see (3.11)).

4.3. A single active center. In the preceding section we considered the branching reaction (4.8). In this section the chain continuation reaction will be added. We consider the reaction scheme



A model of this kind for a branching chain reaction with $A_1 = A_2$ has been considered by various authors (see [Zel 5, Fran 1]). We note that in the case $A_1 = A_2$ the propagation of isothermal waves is described by a scalar equation. In this section we shall consider the system of reactions (1.14) with different initial substances A_1 and A_2 . Despite the simplicity of this system of reactions, existence and stability of waves have not previously been proved for it.

The nondistributed system of equations corresponding to the reactions (4.14) has the form

$$(4.15) \quad \dot{R} = k_1 A_1 R, \quad \dot{A}_1 = -k_1 A_1 R, \quad \dot{A}_2 = -k_2 A_2 R.$$

The balance equation here is $R + A_1 = a_1$, where a_1 is some number. Stationary points of system (4.15) are obtained from the equations $A_1 R = 0$, $A_2 R = 0$. Taking balances into account, we obtain the isolated stationary point $R = a_1$, $A_1 = A_2 = 0$ (we denote this point by u^-) and the half-line of stationary points

$$(4.16) \quad R = 0, \quad A_1 = a_1, \quad A_2 \geq 0.$$

Thus we have an entire face of the balance polyhedron consisting of stationary points. It is readily verified that for the reactions (4.14) Condition 1 of §4.1 is satisfied, and, therefore, in accordance with an assertion of that section, the stationary face (4.16) is not attracting. It is obvious that the graph of reactions (4.14) is open and, therefore, point u^- is stable, a fact which can be verified directly.

We consider, in more detail, the problem concerning the existence of waves joining points of the unstable face (4.16) with the stable point u^- . We show that for each point u^+ of this stationary face there exists a number c^* such that for all $c \geq c^*$ there exists a wave, in fact, a stable wave, joining the stationary points

u^+ and u^- . To this end, we reduce system (4.15) to a monotone system using the change of variables indicated in §2.1:

$$(4.17) \quad R = u_1, \quad A_1 = a_1 - u_1, \quad A_2 = a_2 - u_2,$$

where a_2 is the value of concentration A_2 corresponding to point u^+ . In the new variables, the system of equations for the traveling wave may be written in the form

$$(4.18) \quad \begin{aligned} du_1'' + cu_1' + k_1u_1(a_1 - u_1) &= 0, \\ du_2'' + cu_2' + k_2u_1(a_2 - u_2) &= 0, \end{aligned}$$

with conditions at the infinities: u^+ at $+\infty$ and u^- at $-\infty$, where

$$(4.19) \quad u_1^+ = 0, \quad u_2^+ = 0, \quad u_1^- = a_1, \quad u_2^- = a_2.$$

It follows from (4.17) that in the u_1, u_2 coordinates the balance polyhedron is the half-strip

$$(4.20) \quad 0 \leq u_1 \leq a_1, \quad u_2 \leq a_2.$$

At point u^- the eigenvalues are negative; at point u^+ one eigenvalue is positive, the other is zero, which once again confirms that u^- is a stable point and u^+ is an unstable point of the nondistributed kinetic system. We remark that u^+ is not an isolated stationary point: all the points $u_1 = 0, u_2 \leq a_2$ are also stationary.

To establish the existence of a traveling wave, i.e., solutions of system (4.18) with the conditions (4.19), we apply the method pointed out in Remark 2 of §3.2. To this end, we construct a positive invariant set containing only two stationary points: u^+ and u^- . This set is given by the intersection of the balance polyhedron with the domains

$$(4.21) \quad u_2 \leq ku_1, \quad u_2 \geq 0,$$

where k is a positive constant. If k is chosen sufficiently large, it is then easy to see that at points of the introduced lines lying inside the balance polyhedron the vector field defined by the source in (4.18) is directed towards the interior of the constructed set (see Figure 4.1). It is therefore positive invariant. Thus, the theorem concerning the existence of a wave joining points u^+ and u^- , stated in Remark 1 of §3.2, is valid. For these waves we have stability and a minimax representation of the minimal speed.

As in the preceding section, we can add the stage of termination of the chain (4.13) to the system of reactions considered, and, assuming constant k_0 to be sufficiently small, we can assume approximate fulfillment of the balance $R + A_1 = a_1$. Then all the preceding results remain unchanged.

We consider isothermal waves for the system of reactions (4.14). In the case of nonisothermal processes, in view of the linear independence of the reactions, the system (4.18), as a consequence of an assertion in §2.2 for nonnegative thermal effects, remains monotone, and, therefore, all the conclusions relating to existence and stability of a wave, as well as that concerning a minimax representation of the speed, are valid.

4.4. Two active centers: oxidation of carbon bisulfide. In [Vor 1] a description is given for the propagation of a cold (isothermal) flame in an oxidation

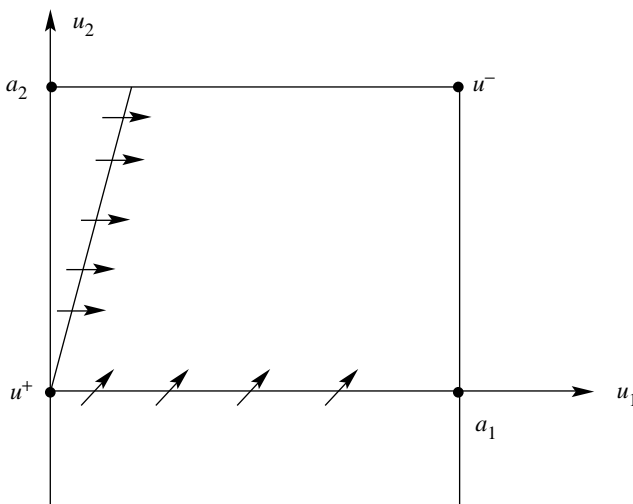
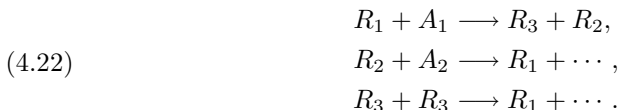

FIGURE 4.1. Positively invariant set for system (4.18)

reaction of carbon bisulfide, observed experimentally by the authors. The mechanism for this process is studied in this and subsequent papers (see [Kon 1, Nov 3, Zel 5]). Two active centers, R_1 and R_2 , are involved in this reaction:



Here A_1 is an initial substance, assumed to be in abundance, A_2 is a second initial substance, and R_3 is an intermediate product. The scheme (4.22) agrees with (1.20), but in a different notation ($R_1 = S$, $R_2 = O$, $A_1 = O_2$, $A_2 = CS_2$, $R_3 = SO$). Besides the chain continuation and branching reactions indicated, there are also reactions involving the loss of active centers, and other reactions which, in certain cases, may not be taken into account, considering their low rates. We restrict our discussion to reactions (4.22).

As shown in §2.2, for the system of reactions (4.22) we obtain a monotone system of equations with the aid of the change of variables (2.1), which in the given case has the form:

$$(4.23) \quad \begin{aligned} R_1 &= -u_1 + u_2 + u_3, & R_2 &= u_1 - u_2, & R_3 &= u_1 - 2u_2, \\ A_1 &= a_1 - u_1, & A_2 &= a_2 - u_2. \end{aligned}$$

The balance polyhedron is specified by conditions of nonnegativeness of the right-hand sides in equations (4.23). The stationary points were pointed out in §1.1. In the new variables they have the form: $u_1 = u_2 = u_3 = 0$ and $u_1 = 2a_2$, $u_2 = u_3 = a_2$. We denote the first of these points by u^+ , the second by u^- . As was established in §1.1, the point u^- is a stable point, u^+ is unstable. However, this is evident directly from the equations for the nondistributed system

$$\dot{u}_i = F_i(u) \quad (i = 1, 2, 3),$$

where the F_i are reaction rates,

$$F_1 = k_1(-u_1 + u_2 + u_3)(a_1 - u_1),$$

$$F_2 = k_2(u_1 - u_2)(a_2 - u_2), \quad F_3 = k_3(u_1 - 2u_2)^2,$$

F_i are nonnegative functions in the balance polyhedron (cf. (2.12)).

Calculation of the eigenvalues at the stationary points leads to the following result: at the stable point two of the eigenvalues are negative, one is zero; at the unstable point, one eigenvalue is negative, two are zero.

Traveling waves are described by the following system of equations:

$$du_i'' + cu' + F_i(u) = 0 \quad (i = 1, 2, 3),$$

with conditions u^+ and u^- at plus and minus infinity, respectively. This system is monotone and, therefore, the results obtained above are applicable to it. Namely, for all $c \geq \omega^*$, where ω^* is obtained with the aid of the minimax representation, there exists a stable traveling wave with speed c . Stability is understood in the sense indicated in §3.2.

As was done above, we can consider nonisothermal processes with nonnegative thermal effects.

4.5. Irreversible reactions. In §§4.2–4.4 we considered models of branching chain processes in the case of one and two active centers. In this section we consider some examples of branching chain reactions with an arbitrary number n of active centers in the case of reactions with an open graph.

We begin with the system of reactions

$$(4.24) \quad A_i + \alpha_i R_i \xrightarrow{k_i} \sum_{j=1}^n \beta_{ij} R_j \quad (i = 1, \dots, n),$$

where $\alpha_i > 0$. We present conditions under which this system describes a branching chain process. For this it is sufficient that conditions (4.4) be satisfied; in the given case, these conditions take the form

$$(4.25) \quad \sum_{j=1}^n \beta_{ij} \lambda_j \geq \alpha_i \lambda_i \quad (i = 1, \dots, n),$$

where at least one of the inequalities is strict and λ_j are nonnegative. In matrix form inequalities (4.25) may be written as

$$(4.26) \quad \lambda \gamma \geq 0, \quad \lambda \gamma \neq 0,$$

where $\lambda = (\lambda_1, \dots, \lambda_n)$,

$$(4.27) \quad \gamma = \begin{pmatrix} \beta_{11} - \alpha_1 & \beta_{21} & \dots & \beta_{n1} \\ \beta_{12} & \beta_{22} - \alpha_2 & \dots & \beta_{n2} \\ \dots & \dots & \dots & \dots \\ \beta_{1n} & \beta_{2n} & \dots & \beta_{nn} - \alpha_n \end{pmatrix}.$$

Matrix γ has nonnegative off-diagonal elements. It is necessary that the following condition be satisfied:

$$(4.28) \quad \det \gamma \neq 0.$$

Then, for the system of reactions (4.24), Condition 1 of §4.1 is satisfied. Therefore,

on the basis of Proposition 4.1, there exists a nondegenerate balance polyhedron Π such that the equations

$$(4.29) \quad R_1 = 0, \dots, R_n = 0$$

specify a stationary point, lying in this polyhedron and being nonattracting. It is easy to see that polyhedron Π can be specified by the equation

$$(4.30) \quad R + \gamma A = \mu,$$

where $R = (R_1, \dots, R_n)$, $A = (A_1, \dots, A_n)$, and μ is a vector given by

$$(4.31) \quad \mu = \gamma A^0,$$

where A^0 is a given positive vector. It is obvious that A^0 is the value of concentration A at the stationary point (4.29).

For the system of reactions (4.24) the monotonicity conditions of §2.2 are satisfied and the kinetic system may be reduced to a monotone system by the substitution (2.1), which in the given case has the form

$$(4.32) \quad A = A^0 - u, \quad R = \gamma u,$$

where $u = (u_1, \dots, u_n)$.

In these variables traveling waves are described by the following system of equations:

$$(4.33) \quad du'' + cu' + w = 0.$$

Here $w = (w_1, \dots, w_n)$ is the vector of the reaction rates:

$$(4.34) \quad w_i = k_i A_i R_i^{\alpha_i} \quad (i = 1, \dots, n).$$

To the system (4.33) we adjoin the conditions at the infinities:

$$(4.35) \quad \lim_{x \rightarrow -\infty} u(x) = u^-, \quad \lim_{x \rightarrow +\infty} u(x) = 0.$$

Thus, at $+\infty$ we have the stationary point (4.29), which is unstable, and at $-\infty$ the stationary point u^- , which we assume to be stable. A stable stationary point of a kinetic system exists by virtue of the openness of the graph of the reactions.

We note, as a consequence of (4.33), that all the stationary points of the kinetic system are determined by the equation

$$(4.36) \quad w = 0.$$

By virtue of (4.34), this means that all the stationary points are obtained from the equations

$$(4.37) \quad A_i R_i = 0 \quad (i = 1, \dots, n)$$

and from the condition for these points to belong to the balance polyhedron Π . The property of a point to belong to the balance polyhedron is connected with the

choice of vector μ (and, consequently, of A^0) appearing in (4.30). For example, consider the stationary point

$$(4.38) \quad A = 0, \quad R > 0.$$

It is clear that at this point $R = \gamma A^0$, and, therefore, we obtain a condition on A^0 for which the point in question belongs to the balance polyhedron:

$$(4.39) \quad \gamma A^0 > 0.$$

Similarly, we can also consider other stationary points and determine conditions under which they belong to the balance polyhedron Π .

Let conditions (4.39) be satisfied. As u^- we select the stationary point (4.38). It follows from (4.32) that $u^- = A^0$. It is clear that this point is isolated and asymptotically stable. The latter follows from the fact that for a nondistributed kinetic system we can take, as the Lyapunov function, the function

$$V = A_1 + \cdots + A_n,$$

which obviously attains a minimum at the point considered.

Thus we can apply to system (4.33) the results of §3 concerning the existence and stability of waves for monotone systems. Here we need to take into account the presence of other unstable stationary points. If they are in the balance polyhedron, then when the conditions of Theorem 4.1 of Chapter 3 about the nonexistence of waves joining unstable stationary points are satisfied, we find that solutions of problem (4.33), (4.35) exist. Under certain additional assumptions we can show that there are no stationary points different from 0 and u^- in polyhedron Π .

We pause to consider in more detail the case in which matrix γ is irreducible. In this case, for satisfaction of conditions (4.26), it is necessary and sufficient that the eigenvalue of the matrix γ with maximal real part is positive. As λ we can take the eigenvector corresponding to the eigenvalue with maximal real part. Therefore, for the case in which matrix γ is irreducible, if conditions (4.26) are satisfied we can take vector λ to be positive and such that inequalities (4.26) are strict.

We can also adduce the following condition.

PROPOSITION 4.2. *In order that the system of reactions (4.24) describe a branching process and satisfy Condition 1 of §4.1, it is sufficient that the following inequality holds:*

$$(4.40) \quad (-1)^{n-1} \det \gamma > 0.$$

PROOF. It is obvious that the eigenvalue with maximal real part of matrix γ is positive, since, otherwise, inequality (4.40) would not be satisfied. Satisfaction of Condition 1 of §4.1 follows from (4.28). This completes the proof of the proposition. \square

We consider the stationary points of a kinetic system.

PROPOSITION 4.3. *If matrix γ is irreducible, then in the intersection G of the balance polyhedron Π with the interval $0 \leq u \leq u^-$ there are no stationary points of the kinetic system different from 0 and u^- .*

PROOF. Without loss of generality, we can assume that the reaction rates are given by the equations

$$(4.41) \quad w_i = k_i A_i R_i \quad (i = 1, \dots, n),$$

which follows from (4.37).

We assume that in G there is a stationary point u^* , different from 0 and u^- . We show that $u^* > 0$. Let us suppose this is not the case and, for definiteness, let $u_i^* = 0$, $i = 1, \dots, k < n$, and $u_i^* > 0$, $i = k + 1, \dots, n$. Let us define the functions

$$\varphi_i(t) = w_i(tu^*) \quad (i = 1, \dots, k).$$

It is obvious that

$$(4.42) \quad \varphi_i(0) = \varphi_i(1) = 0.$$

We have

$$(4.43) \quad \varphi_i'(t) = \sum_{j=n+1}^n \frac{\partial w_i(tu^*)}{\partial u_j} u_j^*.$$

Since $i \leq k < j$ and the system is monotone, we have $\partial w_i / \partial u_j \geq 0$, and, consequently, $\varphi_i'(t) \geq 0$ ($0 \leq t \leq 1$). Together with (4.42), this yields $\varphi_i'(t) \equiv 0$. Therefore,

$$(4.44) \quad \frac{\partial w_j(tu^*)}{\partial u_j} \equiv 0 \quad \text{for } 0 \leq t \leq 1, \quad i = 1, \dots, k; \quad j = k + 1, \dots, n.$$

From (4.41) and (4.42) we obtain

$$\frac{\partial w_i(tu^*)}{\partial u_j} = k_i(A_i^0 - tu_i^*)\gamma_{ji}.$$

Taking t sufficiently small, from (4.44) we have: $\gamma_{ij} = 0$ ($i = 1, \dots, k$; $j = k + 1, \dots, n$). But this contradicts the irreducibility of matrix γ .

We show now that in the polyhedron Π there is an interior point u^0 such that

$$(4.45) \quad u^0 \leq u^*, \quad u_i^0 = u_i^* \quad \text{for some } i.$$

Indeed, it is obvious that inside Π there exists a point $u^1 < u^*$. We join u^1 and u^- by a rectilinear segment. Interior points of this segment lie inside Π . Let u^0 be the point of intersection of this segment with the boundary of the interval $[0, u^*]$. Since $u^0 \leq u^* \leq u^-$ and $u^* \neq u^-$, then $u^0 \neq u^-$ and is an interior point of Π . By virtue of (4.45), $w_i(u^0) \leq w_i(u^*) = 0$, since $\partial w_i / \partial u_j \geq 0$ for $i \neq j$. This contradicts the positiveness of function w_i inside Π . The proposition is thereby established. \square

We proceed now to the problem concerning existence and stability of waves. Based on the proposition just proved and the theorem of §3.2, we can conclude that for all $c \geq \omega^*$, where ω^* is obtained with the aid of the minimax representation (4.4), (4.5) of Chapter 3, there exist solutions of system (4.33), that are monotone with respect to u and satisfy conditions (4.35), for which concentrations $A(x)$ and $R(x)$ are nonnegative. When $c < \omega^*$, such solutions do not exist.

It is easy to see that the matrix $\partial w_i / \partial u_j$ is functionally irreducible and its eigenvalues at point u^- are negative. We can therefore apply the results of Chapter 5 concerning the stability of waves in weighted norms. Namely, we denote by μ_+ the eigenvalue with maximal real part of matrix $\partial w_i / \partial u_j$ at zero. Then, as shown in §4 of Chapter 3, we have the inequality $\omega^* \geq 2(d\mu_+)^{1/2}$ and the following

result concerning stability is valid. If $\omega^* > 2(d\mu_+)^{1/2}$, we then have asymptotic stability of waves in weighted norms for all $c \geq \omega^*$. If $\omega^* = 2(d\mu_+)^{1/2}$, we then have asymptotic stability in weighted norms for $c > \omega^*$. When $c = \omega^*$, the waves are stable in the sense indicated in §3.2.

A case frequently considered in the study of cold flames is the one in which there is a deficiency in one of the initial substances and an abundance in the remaining ones, and a change in them is neglected in the reaction process. Their concentrations are then accounted for in the form of rate constant and the reactions scheme (4.24) can be written in the form

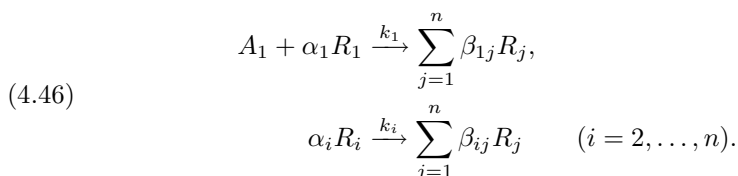

We shall assume that inequalities (4.26) and (4.28) remain valid. Then to the system of reactions (4.46) there corresponds only the one balance:

$$(4.47) \quad A_1 + (r, R) = A_1^0,$$

where $r = (r_1, \dots, r_n)$ is the vector obtained by solving the equation

$$(4.48) \quad r\gamma = e_1.$$

Here $e_1 = (1, 0, \dots, 0)$, $A_1^0 > 0$.

Besides the stationary point (4.29):

$$R = 0, \quad A_1 = A_1^0,$$

which is unstable, there is a second stationary point

$$(4.49) \quad A_1 = 0, \quad r_1 R_1 = A_1^0, \quad R_j = 0 \quad (j = 2, \dots, n),$$

if $r_1 > 0$.

We remark that positiveness of r_1 is a necessary condition for boundedness of the balance polyhedron (4.47), i.e., if $r_1 \leq 0$, then it is not bounded. In addition, there is a unique stationary point in the balance polyhedron and it is unstable. It is easy to see that in this case the sum of concentrations of the active centers increases to infinity in the reaction process. This is a consequence of the fact that we have neglected consumption of the initial substances. Thus, for the indicated choice of substance which is in short supply, waves do not exist.

Let $r_1 > 0$. Then the stable stationary point is specified by equation (4.49). It is clear that there are no other stationary points besides the two indicated. Since the system may be reduced to a monotone system, conclusions analogous to the preceding can then be made concerning existence and stability of a wave.

In the system of reactions (4.24) it was assumed that all the substances A_i are distinct. However, cases are encountered in which the initial substance is consumed in more than one reaction. It can also be the case with the active centers. Here the condition for reducing a system to a monotone one can be violated, and to prove the existence of a wave, it is necessary to use other methods. It is reasonable to expect that here we can construct a rotation of the vector field and apply the Leray-Schauder method, as was done in Chapters 2, 3, and 9. Instability of a wave in the presence of parallel reactions is possible.

4.6. Reversible reactions. The definition of branching chain processes given in §4.1 also allows the presence of reversible stages.

We consider first the following scheme of reactions:

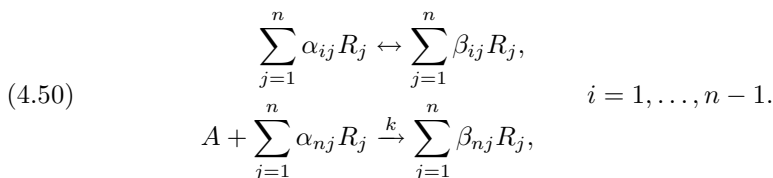

For convenience of exposition we begin with the following simple example of such a scheme:

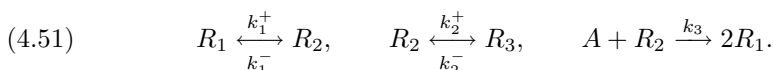

Here we have only the one balance

$$A + R_1 + R_2 + R_3 = a \quad (a > 0).$$

It is easy to find the stationary points

$$(4.52) \quad R_1 = R_2 = R_3 = 0, \quad A = a$$

and

$$(4.53) \quad A = 0, \quad R_1 + R_2 + R_3 = a, \quad k_1^+ R_1 = k_1^- R_2, \quad k_2^+ R_2 = k_2^- R_3.$$

The last equations define a point of detailed equilibrium for the system of reversible reactions in (4.51). The kinetic system (4.51) has no other stationary points.

The system of reactions considered determines a branching chain process: $R_1 + R_2 + R_3$ increases during the reaction process. Therefore, the point (4.52) is unstable. The stationary point (4.53) is asymptotically stable. This could be verified directly; however, we shall do this in the general case for system (4.50). It follows from what was said in §2 that the system corresponding to (4.51) is reducible to a monotone system. New variables can be introduced with the aid of equations (2.1):

$$R_1 = -u_1 + 2u_3, \quad R_2 = u_1 - u_2, \quad R_3 = u_2 - u_3, \quad A = a - u_3.$$

The system of equations for a traveling wave has the form

$$(4.54) \quad du_i'' + cu_i' + f_i(u) = 0 \quad (i = 1, 2, 3),$$

where

$$\begin{aligned} f_1 &= k_1^+(-u_1 + 2u_3) - k_1^-(u_1 - u_2), \\ f_2 &= k_2^+(u_1 - u_2) - k_2^-(u_2 - u_3), \\ f_3 &= k_3(u_2 - u_3)(a - u_3). \end{aligned}$$

As conditions at the infinities, we specify the stationary points (4.52) and (4.53) in the variables u_1, u_2, u_3 . To system (4.54) we can apply the results obtained for monotone systems.

We return now to the system of reactions (4.50). We assume that at least one substance R_j appears on the left and right sides of the reactions. This means that

$$\sum_{j=1}^n \alpha_{ij} > 0, \quad \sum_{j=1}^n \beta_{ij} > 0 \quad (i = 1, \dots, n).$$

We introduce the matrix

$$\gamma = \begin{pmatrix} \gamma_{11} & \cdots & \gamma_{1n} \\ \dots & \dots & \dots \\ \gamma_{1n} & \cdots & \gamma_{nn} \end{pmatrix}, \quad \text{where } \gamma_{ij} = \beta_{ij} - \alpha_{ij}.$$

We assume that this matrix is invertible. Condition 1 of §4.1 is then satisfied.

Condition (4.4), i.e, a condition sufficient for the system of reactions to describe a branching chain process, has the form

$$(4.55) \quad \begin{aligned} \sum_{j=1}^n \lambda_j \gamma_{ij} &= 0 \quad (i = 1, \dots, n - 1), \\ \sum_{j=1}^n \lambda_j \gamma_{nj} &> 0, \quad \text{where } \lambda_j \geq 0 \quad (j = 1, \dots, n). \end{aligned}$$

Without loss of generality, we can assume that λ_j is a solution of the system of equations (4.55) and

$$(4.56) \quad \sum_{j=1}^n \lambda_j \gamma_{nj} = 1.$$

This means that the vector $\lambda = (\lambda_1, \dots, \lambda_n)$ is the last row of the matrix γ^{-1} , the matrix inverse to γ . Thus, in order that the system of reactions (4.50) describe a branching chain process, it is sufficient that the last row of matrix γ^{-1} be nonnegative.

We construct the balance polyhedron Π . Obviously, it has the form

$$(4.57) \quad A + \sum_{j=1}^n \lambda_j R_j = A_0, \quad A \geq 0, \quad R_j \geq 0,$$

where λ_j is a solution of the system (4.55), (4.56), $A_0 > 0$. It is clear that the point

$$(4.58) \quad R_1 = 0, \dots, R_n = 0, \quad A = A_0$$

is a stationary point, and, as follows from Proposition 4.1, it is unstable.

We find the other stationary points. To do this, we write down the kinetic system corresponding to the reactions (4.50):

$$(4.59) \quad \frac{dR}{dt} = \gamma w,$$

where $w = (w_1, \dots, w_n)$, $w_i = w_i^+ - w_i^-$, $i = 1, \dots, n - 1$; w_i^+ , w_i^- are the direct and reverse reaction rates in (4.50), w_n is the rate of the last reaction; $R = (R_1, \dots, R_n)$.

In view of the invertibility of matrix γ , it follows from this that a stationary point is a solution of the system of equations $w = 0$, or

$$(4.60) \quad w_i^+ = w_i^- \quad (i = 1, \dots, n-1), \quad w_n = 0.$$

We consider the stationary point in which $A = 0$:

$$(4.61) \quad A = 0, \quad \sum_{j=1}^n \lambda_j R_j = A_0, \quad w_i^+ = w_i^- \quad (i = 1, \dots, n-1).$$

For the existence of such a stationary point it is necessary and sufficient that this system have a nonnegative solution R_j ($j = 1, \dots, n$). On the basis of a well-known result (see [Vol 9]) this system has a unique positive solution. This solution is a positive point of detailed equilibrium for the system of reversible reactions in (4.50).

We show that the stationary point (4.61) is asymptotically stable in the balance polyhedron Π . It follows from known results for reversible reactions (see [Vol 9]) that for the system of the first $n-1$ reactions in (4.50) the point of detailed equilibrium is asymptotically stable. In addition, the balance plane in which it lies is obviously attracting if the complete system of reactions is considered. From this we can obtain asymptotic stability of point (4.61) for the system of differential equations corresponding to the reactions (4.50).

Thus we have shown that the nondistributed kinetic system corresponding to the reactions (4.50) has at least two stationary points: unstable and asymptotically stable. We can ask the question about the existence of traveling waves joining these points. For the case in which the system reduces to a monotone system, the methods presented above can be applied to it. We have illustrated this by the system of reactions (4.51). Other examples of this type can also be presented.

In the case considered above the number of intermediate substances R_j is equal to the number of reactions. Using similar methods, we consider the case in which the number of intermediate substances is greater than the number of reactions. We limit the discussion to the following example:



Here R_2 and R_3 are active centers; the balance relations are

$$(4.63) \quad \begin{aligned} A + R_2 + R_3 &= a_2 > 0, \\ R_1 + R_2 + 2R_3 &= a_1 > 0. \end{aligned}$$

It is easy to see that Condition 1 of §4.1 is satisfied and that the stationary point

$$(4.64) \quad A = a_2, \quad R_1 = a_1, \quad R_2 = R_3 = 0$$

is unstable. The kinetic system corresponding to the reactions (4.62) is reducible

to a monotone system by means of the substitution (2.1), which, in the given case, has the form

$$R_1 = a_1 - u_1, \quad R_2 = 2u_2 - u_1, \quad R_3 = u_1 - u_2, \quad A = a_2 - u_2.$$

Here we obtain the following equations describing traveling waves:

$$(4.65) \quad du_i'' + cu_i' + f_i(u) = 0 \quad (i = 1, 2),$$

where

$$f_1(u) = k_1^+(a_1 - u_1)(2u_2 - u_1) - k_1^-(u_1 - u_2), \\ f_2(u) = k_2(a_2 - u_2)(u_1 - u_2).$$

In the variables u_1, u_2 the polyhedron Π has the form $u_1 \leq a_1, u_2 \leq a_2, u_2 \leq u_1 \leq 2u_2$; the unstable point (4.64) is $u_1 = 0, u_2 = 0$. There is a second stationary point, which is a point of detailed equilibrium for reversible reactions. It is obtained from the equations

$$u_2 = a_2, \quad k_1^+(a_1 - u_1)(2u_2 - u_1) = k_1^-(u_1 - u_2).$$

We denote it by u^- . This point is asymptotically stable. There are no other stationary points, besides 0 and u^- , in polyhedron Π . Thus, traveling waves defined by system (4.65) with the conditions 0 and u^- at $\pm\infty$ exist and are stable in accordance with the results for monotone systems presented earlier.

Along with the reactions (4.50), the same methods can be considered for reactions containing more than one irreversible stage.

4.7. Interaction of chains. We have considered branching chain processes for which there is a single stable stationary point and also unstable stationary points. In this section we consider processes for which there exist more than one stable stationary point. This is connected with the presence of more than one branching chain in the system of reactions and their interaction. The simplest example exhibiting effects of interest to us is the following:

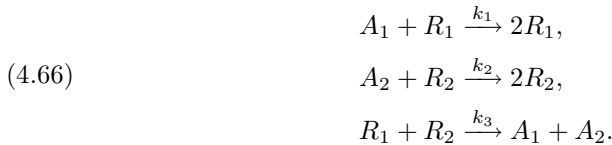

The first and second of these reactions, considered individually, are branching chain reactions, while the third reaction represents an interaction of chains.

For the system of reactions (4.66) we have the balance equations

$$(4.67) \quad A_1 + R_1 = a_1, \quad A_2 + R_2 = a_2,$$

where a_1 and a_2 are positive constants. Taking these balances into account, we obtain the following nondistributed system of equations:

$$(4.68) \quad \begin{aligned} \dot{R}_1 &= k_1 R_1 (a_1 - R_1) - k_3 R_1 R_2, \\ \dot{R}_2 &= k_2 R_2 (a_2 - R_2) - k_3 R_1 R_2 \quad (0 \leq R_1 \leq a_1, \quad 0 \leq R_2 \leq a_2). \end{aligned}$$

The stationary points are obviously the following:

$$(4.69) \quad R_1 = 0, \quad R_2 = 0,$$

$$(4.70) \quad R_1 = 0, \quad R_2 = a_2,$$

$$(4.71) \quad R_1 = a_1, \quad R_2 = 0,$$

$$(4.72) \quad R_1 = r, \quad R_2 = \frac{k_1}{k_3}(a_1 - r),$$

where

$$r = \frac{k_1 k_2 a_1 - k_2 k_3 a_2}{k_1 k_2 - k_3^2},$$

assuming that $0 < r < a_1$.

We find conditions for stability of the points (4.70) and (4.71). Direct calculation of the eigenvalues of the matrix obtained by linearization of the right-hand sides of (4.68) at these points leads to the following result: the eigenvalues are negative if the following inequalities are satisfied:

$$(4.73) \quad \frac{k_2}{k_3} < \frac{a_1}{a_2} < \frac{k_3}{k_1}.$$

We note that from these inequalities it also follows that $0 < r < a_1$. It is also easy to verify that point (4.72) is unstable when conditions (4.73) are satisfied and that point (4.69) is unstable independently of these conditions.

Thus we have shown that when condition (4.73) is satisfied, the kinetic system (4.68) has four stationary points in the balance polyhedron of which two are stable and two unstable.

It may be verified directly that by means of the substitution $R_1 = u_1$, $R_2 = a_2 - u_2$ the system (4.68) is reduced to a monotone system, which has, as stable stationary points, the points $u_1 = 0$, $u_2 = 0$; $u_1 = a_1$, $u_2 = a_2$. Thus, a monotone traveling wave joining these points exists, is unique, and is stable.

We have illustrated the interaction of chains with the simple example (4.66). A similar result may also be obtained in a more general case. Let us assume we have a system of reactions containing two groups of active centers: $R^{(1)} = (R_1^{(1)}, \dots, R_k^{(1)})$ and $R^{(2)} = (R_1^{(2)}, \dots, R_l^{(2)})$. We assume that there is a subsystem of reactions with respect to the active centers $R^{(1)}$ and certain intermediate substances $A^{(1)}$, which, for the given subsystem, are initial substances, and that this subsystem, considered independently, describes a branching chain process. In example (4.66) this corresponds to the first reaction. We assume, further, that there is a second subsystem of analogous reactions with respect to the active centers $R^{(2)}$ and certain intermediate substances $A^{(2)}$, which corresponds to the second reaction in example (4.66). We assume, finally, that there is a third subsystem of reactions in which the active centers from the groups $R^{(1)}$ and $R^{(2)}$ interact, and that, among the reaction products, there are the substances $A^{(1)}$ and $A^{(2)}$. This corresponds to the last reaction in (4.66).

If the first of the indicated subsystems of reactions is considered independently, then, when the conditions indicated in the preceding sections are satisfied, we have unstable and stable stationary points. Similarly for the second subsystem of reactions. It proves to be the case that under certain conditions there correspond two stable stationary points of the complete system to these two stable stationary points for the subsystems.

§5. Other model systems

In addition to the branching chain reactions considered in the preceding section, there are a number of other systems of interest in the applications, which can be studied with the aid of the methods presented above. We present some of these here.

5.1. Belousov-Zhabotinsky reaction. Under certain assumptions traveling waves in Belousov-Zhabotinsky reactions are described by the following system of equations (see [Mur 1]):

$$(5.1) \quad \begin{aligned} u'' - cu' + u(1 - u - rv) &= 0, \\ v'' - cv' - buv &= 0, \end{aligned}$$

where r and b are positive parameters, $u \geq 0$, $v \geq 0$.

A large number of papers have been devoted to the study of this system of equations (see [Bel 1, Doc 1, Gib 1, Kan 6, 7, Kla 1, 2, Mur 1, Osc 1, Troy 2, Ye 1], and references therein). We now show how the results of §3 may be applied to this system of equations.

The system of equations (5.1) is not monotone; however, if we replace u by $1 - u$, we obtain the monotone system of equations

$$(5.2) \quad \begin{aligned} u'' - cu' + (1 - u)(u - rv) &= 0, \\ v'' - cv' - b(1 - u)v &= 0, \quad u \leq 1, \quad v \geq 0. \end{aligned}$$

We find the stationary points of the nondistributed system. We have, obviously, the isolated stationary point

$$(5.3) \quad u = 0, \quad v = 0$$

and the half-axis of stationary points

$$(5.4) \quad u = 1, \quad v \geq 0.$$

Through linearization of the source it is easy to verify that the stationary point (5.3) is asymptotically stable and that the points (5.4) are unstable for $v < 1/r$. We limit the discussion to this case, using the results of §3.

We specify conditions at the infinities for system (5.2) as follows:

$$(5.5) \quad u(+\infty) = 0, \quad v(+\infty) = 0, \quad u(-\infty) = 1, \quad v(-\infty) = v_0,$$

where v_0 is an arbitrary number: $0 < v_0 < 1/r$.

As the positively invariant set, such that point $(1, v_0)$ is an isolated stationary point, we can take the set bounded by the lines $u = 0$, $v = 0$, $v = v_0$, $v = k(u - 1) + v_0$ (see Figure 5.1). Here k is chosen so that $bv(u - rv)^{-1} < k$, which can obviously be done.

Using the results of §3, we can now state that for each v_0 , $0 < v_0 < 1/r$, there exists a number $c^* > 0$, such that for all $c \geq c^*$ there exists a stable monotone traveling wave, i.e., a monotone solution of system (5.2) with the conditions (5.5). For $c < c^*$, no such waves exist. For c^* we have the minimax representation.

5.2. Heterogeneous-catalytic reactions. In the study of heterogeneous-catalytic reactions we take into account, along with the processes of chemical kinetics, diffusion, and heat conduction, convective heat and mass transfer. One of the models describing these processes leads to the system of equations (1.28), to

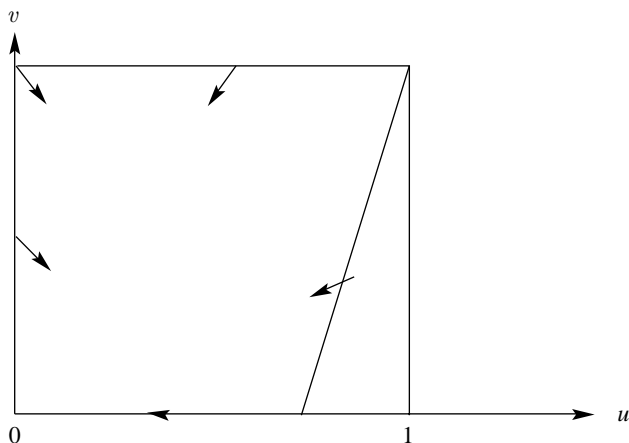

FIGURE 5.1. Positively invariant set for system (5.2)

the left side of which are added the terms $\lambda(A_0 - A)$ and $\lambda(T_0 - T)$, where A_0 and T_0 are constant quantities belonging to the balance polyhedron. If we change to the new variables u , as was done in §3.1, we then obtain the system

$$(5.6) \quad du'' + cu' + F(u) - \lambda(u - u_0) = 0,$$

which differs from (3.3) by only the last term. Moreover, if system (3.3) is monotone, then (5.6) is also a monotone system. Therefore, all the developments of the earlier method are also applicable to this system. Presence of the last term in (5.6) can change the location and types of stationary points.

We illustrate all this with the following simple example. Consider the system of reactions

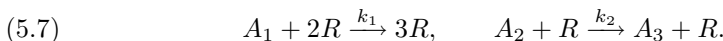

For this system we have the balance

$$(5.8) \quad A_1 + R = a.$$

The nondistributed system of equations has the form

$$(5.9) \quad \begin{aligned} \dot{R} &= k_1 A_1 R^2 + \lambda(R_0 - R), \\ \dot{A}_1 &= -k_1 A_1 R^2 + \lambda(A_{10} - A_1), \\ \dot{A}_2 &= -k_2 A_2 R + \lambda(A_{20} - A_2), \end{aligned}$$

where R_0, A_{10}, A_{20} are given nonnegative numbers, where $R_0 + A_{10} = a$. Let us assume that $R_0 = 0$. Eliminating R with the aid of (5.8), we obtain the system of equations

$$(5.10) \quad \begin{aligned} \dot{A}_1 &= -k_1 A_1 (a - A_1)^2 + \lambda(A_{10} - A_1), \\ \dot{A}_2 &= -k_1 A_2 (a - A_1) + \lambda(A_{20} - A_2), \end{aligned}$$

which is, obviously, a monotone system. The stationary points of this system are readily found. When the condition $0 < \lambda < k_1 a^2/4$ is satisfied, there are three isolated stationary points of which the two endpoints are stable while the

intermediate point is unstable. Since the system is monotone, the results obtained above can then be applied to it.

5.3. Remarks concerning biological models. Equations of the type considered can describe not only a change of concentration in chemical reactions, but also various biological processes. There is a large literature devoted to these problems (see [Bel 1, Mur 1, Rom 1, 2, Svi 2, Volt 1, Zha 1] and references therein). We limit the discussion to two examples illustrating the application of the methods developed above.

Consider the well-known model for the competition of species

$$(5.11) \quad \begin{aligned} \dot{u}_1 &= k_1 u_1 - k_1 u_1^2 - \varkappa_1 u_1 u_2, \\ \dot{u}_2 &= k_2 u_2 - k_2 u_2^2 - \varkappa_2 u_1 u_2. \end{aligned}$$

This system of equations is analogous to the model system (4.68) for the interaction of chains, and its study is entirely similar. Depending on the relationship among the parameters, a different number of stationary points is possible here, including the presence of two stable stationary points. As was the case in §4.7, replacement of u_2 by $1 - u_2$ reduces the system to a monotone system.

As a second example, we consider the biochemical model of Jacob-Monot:

$$(5.12) \quad \dot{u}_1 = a(1 + u_2^2)^{-1} - u_1, \quad \dot{u}_2 = a(1 + u_1^2)^{-1} - u_2.$$

For specified values of parameter a this system has more than one stationary point. Upon replacing u_2 by $a - u_2$ (a is a constant), it may also be reduced to a monotone system.

For distributed systems corresponding to (5.11) and (5.12) the results concerning the existence of waves, their stability, and the representation for the speed are valid.

Bibliographic commentaries

There is a vast literature devoted to the propagation of chain flames (see [Aza 1, Fran 1, Vor 1, Zel 5], and references therein). However, papers in which mathematical modeling of these processes is carried out are few in number. We mention papers [Nov 3, 4, Kag 1–4], which are mostly devoted to a numerical analysis of model systems (see also [Cla 2] and references therein). In [Gray 1] numerical study of an auto-catalytic system is accompanied by asymptotic analysis. In certain cases, under simplified assumptions, a process permits description by a scalar equation [Vor 1, Nov 3, 4]. A brief description of some of the results presented in §§4, 5 can be found in [Vol 24, 26].

Literature relating to waves for the Belousov-Zhabotinsky reaction and for biological models was given previously in §5. There is a number of papers in which propagation of waves for heterogeneous-catalytic reactions is discussed (see [Barel 1, Byk 1, Pro 1, Shk 1], and references therein). Traveling waves in chemical kinetics are studied also in [Brow 1, Fei 1, Fife 13, Fre 4, Koro 1, Ter 7, Vol 1, 2].

Combustion Waves with Complex Kinetics

§1. Introduction

In the preceding chapter it was noted that chemical reaction waves, turning one equilibrium state into another, can be divided into two types. The first case, in which both equilibrium states are stationary points of a kinetic system, was considered in Chapter 8. In this chapter we consider combustion waves involving a strong temperature dependence in the reaction rate; this corresponds to the second case. As is usual in combustion theory, we assume that the chemical reaction rate is very small at low temperatures in comparison with the maximum temperature in the combustion wave. In mathematical formulation this means that a “cut-off” is made in the source (see (1.34) in Chapter 8). Thus, in the given case, one equilibrium state has a kinetic origin while the other is introduced artificially, which corresponds to the physical meaning and guarantees that the mathematical model is well posed.

As we did earlier, let us consider the system of reactions

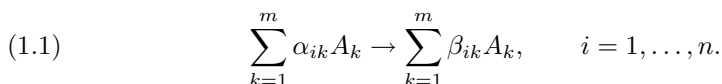

The corresponding system of equations, describing traveling waves, has the form

$$(1.2) \quad \begin{aligned} dA'' + cA' + \Gamma\Phi(a, T) &= 0, \\ \varkappa T'' + cT' + (q, \Phi(A, T)) &= 0. \end{aligned}$$

Here, as usual, $A = (A_1, \dots, A_m)$ is the vector defining concentrations of the reacting substances, T is the temperature, $\Phi = (\Phi_1, \dots, \Phi_n)$, Φ_i is the rate of the i th reaction,

$$(1.3) \quad \Phi_i(A, T) = k_i(T)f_i(A), \quad i = 1, \dots, n,$$

$q = (q_1, \dots, q_n)$, q_i is the adiabatic heating due to the i th reaction, d stands for the coefficients of diffusion, here assumed all equal, \varkappa is the coefficient of thermal diffusivity, and c is the wavespeed, which is unknown, as are also the functions $A(x)$ and $T(x)$. Matrix Γ has the form (1.6) of Chapter 8.

At the infinities, the conditions are given by

$$(1.4) \quad \begin{aligned} A(+\infty) &= A^+, & T(+\infty) &= T^+, \\ A(-\infty) &= A^-, & T(-\infty) &= T^-. \end{aligned}$$

Along with the system of equations (1.2) we shall consider the nondistributed or

kinetic system

$$(1.5) \quad \frac{dA}{dt} = \Gamma\Phi(A, T), \quad \frac{dT}{dt} = (q, \Phi(A, T))$$

and the relations

$$(1.6) \quad (s^k, A^+ - A^-) = 0, \quad k = 1, \dots, m - r,$$

$$(1.7) \quad T^+ - T^- = (p, A^+ - A^-)$$

(see §1 of Chapter 8), where s^k are the vectors forming a complete system of linearly independent solutions of the equation

$$(1.8) \quad s^k \Gamma = 0,$$

and vector p satisfies the equation

$$(1.9) \quad p\Gamma = q.$$

In Chapter 8 we introduced the concept of a reaction with an open graph and we pointed out the basic properties of such reactions. Recall that in this case we assumed the existence of a vector σ for which the following inequality is valid:

$$(1.10) \quad \sigma\Gamma < 0.$$

(A consequence of (1.9), obviously, is that if all reactions are exothermic, i.e., if $q > 0$, then the graph of the reaction is open.) Openness of the graph of a reaction is typical for irreversible reactions, although, of course, not all irreversible reactions have an open graph.

It is easy to see that the function

$$(1.11) \quad V(A) = (\sigma, A)$$

decreases along trajectories of the kinetic system.

We pause briefly to note the contents of this chapter. In §2 the Leray-Schauder method is used to prove existence of waves for reactions with an open graph. Here we consider at first the case in which the transport coefficients are equal ($\varkappa = d$) and thermal effects of the reactions are positive ($q_i > 0$). Next, we waive either the first condition or the second condition. We also consider the problem relating to the influence of a “cut-off” in the source on the existence of waves. In §3 we present a theorem concerning the stability of combustion waves for the case in which system (1.2) is reducible to a monotone system (for $\varkappa = d$). In the last section we give examples of reactions that lead to monotone systems.

§2. Existence of waves for kinetic systems with irreversible reactions

In this section we prove the following theorem concerning the existence of waves for reaction-diffusion systems.

THEOREM 2.1. *Suppose the system of reactions (1.1) is given as well as the corresponding system of equations (1.2), with conditions (1.4) at the infinities, describing a traveling wave. We assume that*

- 1) *reaction rates are given by equations (1.3), (2.1);*
- 2) *A^+ , T^+ is an asymptotically stable stationary point of the kinetic system (1.5) in the balance polyhedron Π , $A^- > 0$, and the necessary conditions (1.6) and (1.7) for the existence of a wave are satisfied;*

3) *intermediate stationary points satisfy Condition 1 of §2.1;*

4) *thermal effects of the reactions are positive ($q_i > 0$);*

5) *a cut-off is made in the source, i.e., relations (1.34) of Chapter 8 apply.*

Then there exists a traveling wave $A(x), T(x)$ joining points A^-, T^- and A^+, T^+ , i.e., solutions of system (1.2) with conditions (1.4). Moreover, the concentrations $A(x)$ are positive, function $V(A(x))$, given by equation (1.11), and temperature $T(x)$ are strictly monotone.

A proof of this theorem is given in §2.4 in the case of equality of transport coefficients ($\varkappa = d$); a proof of the general case is given in §2.6. In §2.5 additions to the theorem are supplied in the case $\varkappa = d$. A problem considered there concerns thermal effects of different signs (see also the supplement to Part III) and it is also shown that if the cut-off is made at different temperatures, we may then have either existence or nonexistence of a wave. In §2.1 we present results that are necessary for studying the existence of waves for equations of chemical kinetics; in §§2.2 and 2.3 transformations of equations are presented.

2.1. Kinetic system. We consider the system of reactions (1.1). Reaction rates are given in the form (1.3), where

$$(2.1) \quad f_i(A) = A_1^{\nu_{i1}} \times \cdots \times A_m^{\nu_{im}} g_i(A),$$

ν_{ik} are arbitrary numbers such that $\nu_{ik} \geq 1$ if $a_{ik} \neq 0$, $\nu_{ik} = 0$ if $a_{ik} = 0$; $g_i(A) > 0$ for $A \geq 0$.

By virtue of condition (1.10), at all stationary points of kinetic system (1.5) we have the equation

$$(2.2) \quad \Phi(A, T) = 0.$$

We consider, in particular, the stationary point A^+, T^+ at which function $V(A)$ attains a minimum. Suppose that at this point l components of vector A^+ vanish and that the remaining components are positive. Since, by assumption, this point is isolated, we have $l \geq r$, where r is the rank of matrix Γ . It is easy to see that with a small change in the given vector $A^- > 0$ we can arrange to have l become equal to r . We shall assume that $l = r$, and we renumber the substances so that the first r substances vanish:

$$(2.3) \quad A_1^+ = 0, \dots, A_r^+ = 0, \quad A_k^+ > 0 \quad (k > r).$$

Let $\widehat{\Gamma}$ denote the matrix consisting of the first r rows of matrix Γ , and let $\widetilde{\Gamma}$ be the matrix consisting of its last $m - r$ rows. It follows from the preceding that the rank of matrix $\widehat{\Gamma}$ is equal to r , and, therefore

$$(2.4) \quad \widetilde{\Gamma} = R\widehat{\Gamma},$$

where R is a matrix of dimensions $(m - r) \times r$.

PROPOSITION 2.1. *Let $\overline{A}, \overline{T}$ be an isolated stationary point of system (1.5) and assume that in it exactly r concentrations $\overline{A}_{k_1}, \dots, \overline{A}_{k_r}$ equal zero, where $k_1, \dots, k_r, k_{r+1}, \dots, k_m$ is a rearrangement of the numbers $1, \dots, m$. Then for each substance A_{k_i} ($i = 1, \dots, r$), a reaction may be found in which this substance is consumed and in which the substances A_{k_j} ($j \neq i, j = 1, \dots, r$) are not consumed.*

In view of its simplicity we shall not supply a proof of this proposition.

We apply this proposition to the stationary point A^+, T^+ . Let us renumber the reactions so that substance A_k is consumed in the k th reaction ($k = 1, \dots, r$). We denote by Γ_0 the matrix consisting of the first r columns and rows of matrix Γ . It then follows from Proposition 2.1 that matrix Γ_0 has nonnegative off-diagonal elements.

We assume that the numbers ν_{ik} appearing in (2.1) satisfy the condition

$$(2.5) \quad \nu_{ik} \leq 1 \quad (i = 1, \dots, n; \quad k = 1, \dots, m).$$

Later on, in proving the existence of waves, we shall get rid of this condition.

Let

$$(2.6) \quad \widehat{A} = (A_1, \dots, A_r), \quad \widetilde{A} = (A_{r+1}, \dots, A_m).$$

Then from equation (2.4), for solutions of the kinetic system (1.5) it follows that

$$(2.7) \quad \widetilde{A} = R\widehat{A} + \widetilde{A}^+.$$

From (1.5) it also follows that

$$(2.8) \quad \frac{dA}{dt} = \Psi(\widehat{A}, T),$$

where

$$(2.9) \quad \Psi(\widehat{A}, T) = \widehat{\Gamma}\Phi(A, T)$$

and A is expressed in terms of \widehat{A} from (2.7). It is readily verified directly that

$$(2.10) \quad \Psi'_{\widehat{A}} \Big|_{\widehat{A}=0} = \widehat{\Gamma}P,$$

where matrix P is nonnegative, has nonzero elements in each of its columns, and is such that matrix $\widehat{\Gamma}P$ has nonnegative off-diagonal elements.

PROPOSITION 2.2. *There exists a vector $s > 0$ such that*

$$(2.11) \quad s\widehat{\Gamma} < 0.$$

All eigenvalues of matrices Γ_0 and $\widehat{\Gamma}P$ lie in the left half-plane.

PROOF. From (1.10) and (2.4) we obtain (2.11), where $s = \sigma_1 + \sigma_2 R$, $\sigma = (\sigma_1, \sigma_2)$. Further, from (2.7) we have $(\sigma, A) = (s, \widehat{A}) + \sigma_2 \widehat{A}^+$. Consequently, (s, \widehat{A}) has a minimum for $\widehat{A} = 0$ relative to $\widehat{A} \geq 0$, from which it follows that $s > 0$. The remaining assertions follow from (2.11) and from the fact that Γ_0 and $\widehat{\Gamma}P$ have nonnegative off-diagonal elements. This completes the proof of the proposition. \square

It follows from Proposition 2.2 that an arbitrary solution s of inequality (2.11) is positive since matrix Γ_0 has an inverse with nonpositive elements. The set of all solutions s of equation (2.11) forms a cone in r -dimensional space. We consider matrix B , the rows of which are linearly independent vectors of this cone. Matrix B is invertible and positive, and we have the equation

$$(2.12) \quad B\widehat{\Gamma} = -K,$$

where $K > 0$. Later on, matrix B will be used to reduce system (1.2) to a locally monotone system.

We consider the intermediate stationary points \bar{A} , \bar{T} . As already noted, a stationary point is characterized by the equations

$$(2.13) \quad A_{k_1} = 0, \dots, A_{k_s} = 0, \quad A_k > 0 \quad (k \neq k_1, \dots, k_s).$$

We remark that an intermediate point is not asymptotically stable in Π . Indeed, then, it would be an isolated point in Π . Joining \bar{A} with A^+ by a line segment, we find that along this segment, in the direction from \bar{A} to A^+ , function $V(A)$ decreases. If we take a point $A^0 \neq \bar{A}$ lying on this segment, then $V(A^0) < V(\bar{A})$ and, therefore, the solution of system (1.5) with initial point A^0 and corresponding value T cannot be attracted to \bar{A} , \bar{T} , since $V(A)$ is decreasing along the trajectories of system (1.5).

Equations (2.13) define a face of the balance polyhedron Π . The face (2.13) on which equation (2.2) is satisfied will be referred to as a stationary face. If it is not a part of another stationary face, we shall call it a maximum stationary face.

Let (2.13) be a maximum stationary face. Let us denote it by Π_0 . We shall require the following condition.

CONDITION 1. There exists a vector μ such that

$$(2.14) \quad (\mu, A - \bar{A}) > 0$$

for all $\bar{A} \in \Pi_0$, $A \notin \Pi_0$, $A \in \Pi$, and

$$(2.15) \quad \mu\Gamma\Phi(A, T) \geq 0$$

in some neighborhood of face Π_0 in Π and corresponding T .

Condition 1 is the condition mentioned in the Introduction. If this condition is satisfied in the homotopy process, then a wave cannot be "attracted" to an intermediate stationary point. This will be proved in §2.4.

The following condition, more suitable for explicit verification, is sufficient for Condition 1 to be satisfied:

CONDITION 1'. There exists a vector μ such that $\mu_k > 0$ for $k = k_j$ ($j = 1, \dots, s$), $\mu_k = 0$ for $k \neq k_j$ ($j = 1, \dots, s$), and

$$(2.16) \quad \mu\Gamma \geq 0.$$

It is not difficult to show that if an intermediate stationary point is isolated in Π and if inequalities (2.5) are satisfied, then Condition 1 holds for this stationary point. If the reactions are independent ($r = n$), then Condition 1' holds for the intermediate isolated stationary points, where satisfaction of inequalities (2.5) is no longer required. We can point out several other examples in which Condition 1 is satisfied. The question as to whether this condition is satisfied for all intermediate points in reactions for which (1.10) holds remains open for the present.

In certain cases intermediate stationary points do not exist. Then, naturally, Condition 1 is not needed. This is the case, for example, when $r = m$, i.e., the rows of matrix Γ are linearly independent. Then, under the above assumption that the stationary point A^+ is isolated, it is a unique stationary point.

2.2. Reduction to a locally monotone system. We show that by a linear change of the variables A and T system (1.2) can be reduced to a locally monotone system (see §2.7 of Chapter 3).

Let us make the change of variables

$$(2.17) \quad u = B\hat{A}, \quad \theta = \frac{T^+ - T}{T^+ - T^-},$$

where \hat{A} is given by equation (2.6) and matrix B is defined as in (2.12). The equation for \hat{A} has, by virtue of (1.2), the form

$$(2.18) \quad d\hat{A}'' + c\hat{A}' + \hat{\Gamma}\Phi(A, T) = 0,$$

where $\hat{\Gamma}$ is the matrix appearing in (2.4). From this and from (1.2) we obtain, upon using equations (2.17) and (2.12),

$$(2.19) \quad \begin{aligned} du'' + cu' - K\Phi(u, \theta) &= 0, \\ \varkappa\theta'' + c\theta' - (q, \Phi(u, \theta)) &= 0. \end{aligned}$$

Here, to avoid introducing new notation, we have denoted function $\Phi(A, T)$ by $\Phi(u, \theta)$, where A is expressed in terms of u through the relations

$$(2.20) \quad \hat{A} = B^{-1}u, \quad \tilde{A} = RB^{-1}u + \tilde{A}^+$$

(see (2.6) and (2.7)), and T is expressed in terms of θ in accordance with equation (2.17); the quantity $q/(T^+ - T^-)$ is again denoted by q (in what follows only the last value q will be used).

According to (1.4), conditions at the infinities in the new variables have the form

$$(2.21) \quad \begin{aligned} u(+\infty) &= 0, & \theta(+\infty) &= 0, \\ u(-\infty) &= u^-, & \theta(-\infty) &= 1, \end{aligned}$$

where

$$(2.22) \quad u^- = B\hat{A}^-.$$

Denoting by $k_i(\theta)$ the function $k_i(T)$ in which T is expressed in terms of θ according to (2.17), we shall have, in place of (1.34) of Chapter 8,

$$(2.23) \quad \begin{aligned} k_i(\theta) &= 0 \text{ for } \theta \geq \theta^*, \\ k_i(\theta) &> 0 \text{ for } \theta < \theta^*, \end{aligned} \quad i = 1, \dots, n,$$

where θ^* is some number:

$$(2.24) \quad 0 < \theta^* < 1.$$

Under the assumptions made, function $\Phi(u, \theta)$ vanishes at the stationary points given by equation (2.21):

$$(2.25) \quad \Phi(0, 0) = 0, \quad \Phi(u^-, 1) = 0.$$

In the new variables equation (1.7) has the form

$$(2.26) \quad (p, u^-) = 1,$$

where vector p is defined by the equation

$$(2.27) \quad pK = q.$$

Equation (2.26) can also be obtained directly from system (2.19), upon multiplying the equation for u by p , subtracting from the equation for θ , and integrating.

Matrix B appearing in (2.12) is selected nonuniquely. It is easy to show that it can be selected so that vector p appearing in (2.27) is a positive vector if $q > 0$.

Thus, the change of variables (2.17) has led to the system (2.19), which is locally monotone (in the sense of the definition given in §2.7 of Chapter 3) in the domain where $A > 0$ provided that thermal effects of the reactions are positive. Indeed, for $\theta < \theta^*$ we have $\Phi(u, \theta) > 0$ and, therefore, the sources in system (2.19) are negative. When $\theta \geq \theta^*$, the sources vanish.

2.3. Change of source. To apply the Leray-Schauder method it is necessary to change the source in system (2.9) so that at the stationary points $u = 0, \theta = 0$ and $u = u^-, \theta = 1$ the linearized source will have eigenvalues in the left half-plane. This is done by introducing a small parameter $\varepsilon > 0$ with a subsequent approach to a limit as $\varepsilon \rightarrow 0$.

Instead of the function Φ_i given by equations (1.3), (2.1), we specify the functions

$$\Phi_i^\varepsilon(A, T) = k_i(T)A_1^{\mu_{i1}} \times \cdots \times A_m^{\mu_{im}} g_i^\varepsilon(A)$$

that are obtained as follows. If $\nu_{ik} > 1$, then instead of $A_k^{\nu_{ik}}$ we substitute the function $A_k(\varepsilon + A_k)^{\nu_{ik}-1}$. The factor $(\varepsilon + A_k)^{\nu_{ik}-1}$ is included in the function $g_i^\varepsilon(A)$. Thus the functions $\Phi_i^\varepsilon(A, T)$ have the same form as the functions $\Phi_i(A, T)$, and the following conditions are satisfied:

$$\mu_{ik} = 1 \text{ for } a_{ik} > 0, \quad \mu_{ik} = 0 \text{ for } a_{ik} = 0.$$

Functions $\Phi_i^\varepsilon(u, \theta)$ are determined from the functions $\Phi_i^\varepsilon(A, T)$, as above, with the aid of the substitutions (2.17) and (2.20). Obviously, for $\varepsilon = 0$ we obtain the initial functions.

Next, we change the source in a neighborhood of the point $u^-, 1$. To do this, we introduce a smooth function $\omega(\xi)$ of the real variable ξ satisfying the conditions:

$$\omega(\xi) = \begin{cases} 1 & \text{for } \xi < \delta/2, \\ 0 & \text{for } \xi > \delta, \end{cases}$$

$\omega'(\xi) < 0$ for $\delta/2 < \xi < \delta$. Here δ is a sufficiently small number. Instead of (2.19) we consider the system

$$(2.28) \quad du'' + cu' + f(u, \theta) = 0,$$

$$(2.29) \quad \varkappa\theta'' + c\theta' + g(u, \theta) = 0,$$

where

$$(2.30) \quad f(u, \theta) = -K\Phi^\varepsilon(u, \theta) + \varepsilon\omega(|u^- - u|)(u^- - u),$$

$$(2.31) \quad g(u, \theta) = (p, f(u, \theta)) - \varepsilon\theta + \varepsilon(p, u);$$

here vector p is defined by equation (2.27).

We also change matrix Γ , replacing β_{ik} by $\beta_{ik} + \varepsilon$.

Obviously, for $\varepsilon = 0$ system (2.28), (2.29) coincides with the initial system (2.19). System (2.28), (2.29) is considered with the conditions (2.21) at the infinities. It is readily verified that at the points $u = 0, \theta = 0$ and $u = u^-, \theta = 1$ the linearized source has all eigenvalues in the left half-plane (see Proposition 2.2 of §2.1).

2.4. Case of equal transport coefficients ($\varkappa = d$). In this section we shall prove existence of waves in the case $\varkappa = d$. Results of this section will be used later on. Proof of the existence of waves will be carried out by the Leray-Schauder method in a way analogous to that used in Chapter 3. The difference consists in the fact that the system considered in Chapter 3 was locally monotone over the whole interval $[0, u^-]$, whereas the system considered here is locally monotone only in that part of the interval where the concentrations A_k are positive. Therefore we need to separate solutions monotone with respect to u and positive with respect to A . A priori estimates will be obtained for such solutions.

In the case $\varkappa = d$ the temperature θ can be eliminated from system (2.28). To do this, we multiply (2.28) by p and subtract from (2.29). Letting

$$y(x) = \theta(x) - (p, u(x)),$$

we obtain the equation

$$dy'' + cy' - \varepsilon y = 0.$$

From (2.21) we obtain, taking into account (2.26),

$$y(+\infty) = 0, \quad y(-\infty) = 0.$$

Consequently, $y(x) \equiv 0$, i.e.,

$$\theta(x) = (p, u(x))$$

for all x . We substitute this expression into system (2.28). Setting

$$(2.32) \quad \varphi(u) = f(u, (p, u)),$$

we obtain the system

$$(2.33) \quad du'' + cu' + \varphi(u) = 0$$

with the following conditions at the infinities:

$$(2.34) \quad u(+\infty) = 0, \quad u(-\infty) = 1.$$

2.4.1. *Homotopy.* Homotopy is made for an arbitrary sufficiently small fixed $\varepsilon > 0$, and, then to prove existence of a wave for $\varepsilon = 0$ we pass to the limit with respect to ε . It is convenient to describe a homotopy starting from a given system, and moving it to a model system. The existence proof will be carried out in the reverse direction of the homotopy, since here a domain must be constructed along whose boundary a rotation is calculated in the application of the Leray-Schauder method. The homotopy is carried out in three steps.

First step. We perform a localization of the source in a neighborhood of the stationary points 0 and u^- . Homotopy of the source is given by the equation

$$(2.35) \quad \begin{aligned} \varphi_\tau^1(u) = & -[\tau + (1 - \tau)\omega(|u|)]K\Phi^\varepsilon(u, \theta) \\ & + \varepsilon\omega(|u^- - u|)(u^- - u) \quad (0 \leq \tau \leq 1). \end{aligned}$$

Here, and later in this section, we use the notation

$$(2.36) \quad \theta = (p, u).$$

Thus the system considered has the form

$$(2.37) \quad du'' + cu' + \varphi_\tau^1(u) = 0,$$

where, for $\tau = 0$, the source has the form

$$(2.38) \quad \varphi_0^1(u) = -\omega(|u|)K\Phi^\varepsilon(u, \theta) + \varepsilon\omega(|u^- - u|)(u^- - u).$$

Second step. Before describing the second stage of the homotopy, we note, by virtue of the assumptions, indicated above, connected with isolatedness of the stationary point $u = 0$, that the source has the form

$$\Phi_i^\varepsilon(A, T) = k_i(T)A_{r+1}^{\mu_{ir+1}} \times \cdots \times A_m^{\mu_{im}} g_i^\varepsilon(A)A_i \quad (i = 1, \dots, r).$$

In accordance with this we make the following homotopy of the source

$$(2.39) \quad \Phi_{i\tau}^\varepsilon(A, T) = [(1 - \tau) + \tau k_i(T)A_{r+1}^{\mu_{ir+1}} \times \cdots \times A_m^{\mu_{im}} g_i^\varepsilon(A)] \times A_i \quad (i = 1, \dots, r),$$

$$(2.40) \quad \Phi_{i\tau}^\varepsilon(A, T) = \tau \Phi_i^\varepsilon(A, T) \quad (i = r + 1, \dots, m).$$

Thus, for $\tau = 1$ the source $\Phi_{i\tau}^\varepsilon$ coincides with the initial source, and for $\tau = 0$ it has the form

$$(2.41) \quad \Phi_{i0}^\varepsilon(A, T) = A_i \quad (i = 1, \dots, r), \quad \Phi_{i0}^\varepsilon(A, T) = 0 \quad (i > r).$$

The source $\varphi_0^1(u)$ is homotoped as follows:

$$(2.42) \quad \varphi_\tau^2(u) = -\omega(|u|)K\Phi_\tau^\varepsilon(u, \theta) + \varepsilon\omega(|u^- - u|)(u^- - u) \quad (0 \leq \tau \leq 1).$$

Under such a homotopy the source coincides with (2.38) for $\tau = 1$. For $\tau = 0$ it has the form

$$(2.43) \quad \varphi_0^2(u) = \omega(|u|)B\Gamma_0 B^{-1}u + \varepsilon\omega(|u^- - u|)(u^- - u).$$

The third step consists in effecting a homotopy of matrices B and Γ_0 according to the formulas

$$(2.44) \quad \Gamma^\tau = \Gamma_0\tau + (\tau - 1)E, \quad B^\tau = B\tau + (\tau - 1)(\Gamma^\tau)^{-1}.$$

Here we obviously have

$$(2.45) \quad B^\tau > 0, \quad B^\tau \Gamma^\tau < 0.$$

The source has the form

$$(2.46) \quad \varphi_\tau^3(u) = \omega(|u|)B^\tau \Gamma^\tau (B^\tau)^{-1} + \varepsilon\omega(|u_-^\tau - u|)(u_-^\tau - u),$$

where

$$(2.47) \quad u_-^\tau = B^\tau \hat{A}^-.$$

The relationship between variables u and A is given by the equations

$$(2.48) \quad u = B^\tau \hat{A}, \quad \tilde{A} = R\hat{A} + A^+.$$

Thus, for $\tau = 0$ we have

$$(2.49) \quad \varphi_0^3(u) = -\omega(|u|)u + \varepsilon\omega(|u_-^0 - u|)(u_-^0 - u).$$

Thus, in the homotopy process we obtain the system

$$(2.50) \quad du'' + cu' + \varphi_\tau^i(u) = 0 \quad (i = 1, 2, 3; \quad 0 \leq \tau \leq 1)$$

with the conditions

$$(2.51) \quad \begin{aligned} u(+\infty) &= 0, & u(-\infty) &= u_-^{i,\tau} \quad (i = 1, 2, 3), \\ u_-^{i,\tau} &= u^- \text{ for } i = 1, 2; & u_-^{i,\tau} &= u_-^\tau \text{ for } i = 3. \end{aligned}$$

2.4.2. *Separation of solutions monotone with respect to u and positive with respect to A.* We show that there exists a positive number ρ such that

$$(2.52) \quad \|u_M - u_N\|_\mu \geq \rho.$$

Here $u_M(x)$ is an arbitrary solution of system (2.50) for $i = 1, 2, 3, 0 \leq \tau \leq 1$, strictly monotone with respect to x , such that the corresponding concentrations $A(x)$, given by equations (2.20), are positive; $u_N(x)$ is an arbitrary solution of system (2.50) not possessing these properties. We remark that in inequality (2.52) u_M and u_N can correspond to different τ and i .

We shall use the a priori estimate

$$(2.53) \quad \|u_M - \psi\|_\mu \leq R$$

for all the indicated solutions u_M ; this estimate will be obtained below (§2.4.3). The constant R is independent of u_M ; ψ is the function introduced in §1 of Chapter 2.

Suppose that the indicated number ρ does not exist. Then we have a sequence $\tau_k \rightarrow \tau_0$ of values of parameter τ for some $i = 1, 2, 3$ and sequences u_M^k and u_N^k , such that

$$(2.54) \quad \|u_M^k - u_N^k\|_\mu \rightarrow 0$$

as $k \rightarrow \infty$. Here u_M^k is the solution of system (2.50) corresponding to $\tau = \tau_k$ in which $c = c^k$, where $c^k = c(u_M^k)$ is a value of the functional introduced in §1 of Chapter 2.

It follows from the a priori estimate (2.53) that the sequence u_M^k is weakly compact in $W_{2,\mu}^1$ and we can therefore assume it converges weakly to some element $u^0 - \psi$. By virtue of the fact that u_M^k is a solution of system (2.50), we find, based on estimates of operators from below (see §1 of Chapter 2), that $u_M^k - \psi$ converges strongly to $u^0 - \psi$.

Thus

$$(2.55) \quad \|u_M^k - u^0\|_\mu \rightarrow 0.$$

Since u_M^k are solutions of system (2.50) and there are a priori estimates (uniform with respect to τ) of the first and second derivatives (see §2 of Chapter 3), it follows that $u_M^k \rightarrow u^0$ in C^1 . It also follows from (2.55) that $c^k \rightarrow c^0 = c(u^0)$. Thus, $u^0(x)$ is a solution of (2.50) for $\tau = \tau^0, c = c^0$.

It follows from (2.54) and (2.55) that

$$(2.56) \quad \|u_N^k - u^0\|_\mu \rightarrow 0.$$

As was the case above, it may be proved that $u_M^k \rightarrow u^0$ in the C^1 -norm.

To proceed we require a lemma concerning strict positiveness of solutions.

LEMMA 2.1. *Consider the system*

$$d_k A_k'' + c A_k' + f_k(A) A_k + g_k(A) = 0 \quad (k = 1, \dots, m),$$

where $A = (A_1, \dots, A_m)$, $d_k > 0$, $f_k(A)$, $g_k(A)$ are smooth functions, $g_k(A) \geq 0$ for $A \geq 0$.

Let $A(x)$ be a smooth nonnegative solution of this system on the interval $[a, b]$. Then $A_k(x)$ ($k = 1, \dots, m$) are either strictly positive for $x \in (a, b)$ or identically equal to zero.

PROOF. Suppose that $A_k(x) \geq 0$ and is not identically equal to zero. Consider the parabolic equation

$$\frac{\partial v}{\partial t} = d_k \frac{\partial^2 v}{\partial x^2} + c_k \frac{\partial v}{\partial x} + f_k(A)v + g_k(A)$$

with initial condition

$$v|_{t=0} = A_k(x)$$

and boundary condition

$$v|_{x=a} = A_k(a), \quad v|_{x=b} = A_k(b).$$

By the theorem about positiveness of solutions of parabolic equations, $v(x, t) > 0$. Hence the assertion of the lemma follows since $v(x, t) \equiv A_k(x)$. This completes the proof of the lemma. \square

Let $A^0(x)$ be the function corresponding to the function $u^0(x)$ (see (2.20)). Since it is the limit of positive functions, it is nonnegative. Using Lemma 2.1, we show that it is strictly positive. To do this we write equations for A at each homotopy step. At the first step it has the form

$$(2.57) \quad dA'' + cA' + [\tau + (1 - \tau)\omega(|u|)]\Gamma\Phi^\varepsilon(A, T) + \varepsilon\omega(|u^- - u|)(A^- - A) = 0,$$

where T is expressed in terms of A in accordance with equations (2.20) and (2.36).

At the second homotopy step the equation for A has the form

$$(2.58) \quad dA'' + cA' + \omega(|u|)\Gamma\Phi_\tau^\varepsilon(A, T) + \varepsilon\omega(|u^- - u|)(A^- - A) = 0,$$

where functions Φ_τ^ε are given by equations (2.39) and (2.40).

At the third homotopy step we have

$$(2.59) \quad dA'' + cA' + \omega(|u|)\Gamma_1^\tau \widehat{A} + \varepsilon\omega(|u_-^\tau - u|)(A^- - A) = 0,$$

where Γ_1^τ is a matrix of order $m \times r$, the first r rows of which are formed by rows of matrix Γ^τ and the last $m - r$ rows by rows of the matrix $R\Gamma^\tau$.

It is easy to see that equations (2.57) satisfy the conditions of Lemma 2.1. In the systems (2.58) and (2.59) the first r of the equations, i.e., the equations for A_1, \dots, A_r , also satisfy the conditions of Lemma 2.1. Recall that the matrices Γ_0 and Γ^τ have non-negative off-diagonal elements. The last $m - r$ equations of system (2.58) and (2.59) satisfy conditions of Lemma 2.1 outside of a δ -neighborhood of the point $u = 0$. Thus we have established positiveness of the function $A^0(x)$.

We show that function $u^0(x)$ is strictly monotone. It is monotone (possibly, non-strict) as the limit in C^1 of monotone functions. Strict monotonicity of the function $u^0(x)$ follows from the lemma of §2.7 of Chapter 3 since the conditions of this lemma are satisfied along solutions $u(x)$ for positive $A(x)$.

Consider now the sequence $u_N^k(x)$. We show that for sufficiently large k the corresponding functions $A^k(x)$ are positive. Suppose this not to be the case. Then there exists a sequence x_k such that

$$(2.60) \quad A_i^k(x_k) \leq 0$$

for some i and for some subsequence of values k . Introducing new indexing, we can assume that this holds for all sufficiently large k .

We consider first the case in which $\{x_k\}$ is a bounded sequence. We can then assume that $x_k \rightarrow x_0$. Since the sequence $A_i^k(x)$ converges uniformly to $A_i^0(x)$, we then arrive at a contradiction with the strict positiveness of function $A_i^0(x)$.

If $x_k \rightarrow -\infty$ along some subsequence, we then arrive at a contradiction since $A_i^- > 0$.

It remains to consider the case in which $x_k \rightarrow +\infty$ along some subsequence. Obviously, the functions $A_i^k(x_k)$ ($i = r + 1, \dots, m$) are positive for sufficiently large k by virtue of the positiveness of A_i^+ for $i = r + 1, \dots, m$. Consider the functions $A_i^k(x)$ for $i \leq r$. To this end, we consider equations (2.57)–(2.59) with respect to \hat{A} in a sufficiently small neighborhood of point $\hat{A} = 0$. From the equation $u = B^\tau \hat{A}$ and the boundedness of matrix B^τ we conclude, for sufficiently small $|\hat{A}|$, that $\omega(|u|) = 1$, $\omega(|u^- - u|) = 0$. Consequently, for sufficiently small $|\hat{A}|$ the equations (2.57)–(2.59) for \hat{A} take the form

$$(2.61) \quad d\hat{A}'' + c\hat{A}' + \hat{\Gamma}\Phi_\tau^\varepsilon(A, T) = 0$$

at the first and second steps of the homotopy and

$$(2.62) \quad d\hat{A}'' + c\hat{A}' + \hat{\Gamma}^\tau \hat{A} = 0$$

at the third step of the homotopy. Let

$$M_\tau = (\hat{\Gamma}\Phi_\tau^\varepsilon(A, T))'_{\hat{A}} \Big|_{\hat{A}=0}.$$

The matrices M_τ have nonnegative off-diagonal elements and their eigenvalues with maximal real parts are negative. Matrix Γ^τ possesses this very same property; this follows directly from its form (2.44). We can use Lemma 5.3 of Chapter 4, by virtue of which there exists a number $x = \bar{x}$, such that if solutions $\hat{A}(x)$ of system (2.61), (2.62) satisfy conditions $\hat{A}(\bar{x}) > 0$, $\hat{A}(+\infty) = 0$, we then have the inequality $\hat{A}(x) > 0$ for all $x > \bar{x}$.

Indeed, consider first the equation (2.61) and let $\Psi_\tau(\hat{A}) = \hat{\Gamma}\Phi_\tau^\varepsilon(A, T)$. Then $\Psi'_{\tau\hat{A}}$ for $\hat{A} = 0$ has positive off-diagonal elements. Let us set

$$B(x) = \int_0^1 \Psi'_{\tau\hat{A}}(t\hat{A}) dt,$$

so that $\Psi_\tau(\hat{A}) = B(x)\hat{A}$. To the system written in this way we now apply Lemma 5.3 of Chapter 4. It is easy to see that \bar{x} can be chosen uniquely for all τ .

For system (2.62) matrix Γ^τ has positive off-diagonal elements for all $\tau > 0$. When $\tau = 0$ it is equal to $-E$, but it is easy to see that the assertions of Lemma 5.3 of Chapter 4 are valid even in this case.

By virtue of the fact that $\hat{A}^0(\bar{x}) > 0$ and $A^k(x)$ converges to $\hat{A}^0(x)$, we conclude that for sufficiently large k the inequality $\hat{A}^k(\bar{x}) > 0$ holds. Since the function $\hat{A}^k(x)$

satisfies system (2.61) or (2.62) for some τ , it then follows from this that $\widehat{A}^k(x) > 0$ for $x > \bar{x}$ for all sufficiently large k . But this contradicts inequality (2.60) for $x > \bar{x}$.

Thus we have shown that functions $A^k(x)$, corresponding to sequence $u_N^k(x)$, are positive for all sufficiently large k . Hence, according to the definition of the functions $u_N^k(x)$, it follows that they cannot be monotone. This means that there exists a sequence x_k such that

$$(2.63) \quad (u_{N_i}^k(x))' = 0$$

for some i (here, and in what follows, we have in mind a possible transition to subsequences).

Sequences x_k cannot be bounded since $(u_{N_i}^k(x))' \rightarrow u^{0'}(x)$ uniformly and $u^0(x)$ is a strictly monotone function. Let

$$(2.64) \quad x_k \rightarrow +\infty.$$

We assume that x_0 is so large that $u^0(x_0)$ lies in a δ -neighborhood of the point $u = 0$. This is then the case also for $u_N^k(x)$ for sufficiently large k . For $|u| < \delta$ the functions $\varphi_\tau^i(u)$ appearing in equation (2.50) are negative for those u to which there correspond positive A . Therefore $\varphi_\tau^i(u_N^k(x))$ are negative for $x > x_0$ and sufficiently large k . For $x_k > x_0$ it follows from (2.63) that x_k is a minimum point of the function $u_{N_i}^k(x)$, more precisely, $u_{N_i}^{k''}(x_k) > 0$. This follows from equation (2.50) in view of the negativeness of $\varphi_\tau^i(u)$. We note that $u_{N_i}^k(x) > 0$ since $u(x) = B^\tau A(x)$, $A(x) > 0$, $B^\tau > 0$. Since $u_{N_i}^k(x) \rightarrow 0$ as $x \rightarrow \infty$, for some $\bar{x} > x_k$ the function $u_{N_i}^k(x)$ attains a maximum, which leads to a contradiction in signs in equation (2.50). This contradiction implies that (2.64) cannot be valid.

It remains only to consider the case

$$(2.65) \quad x_k \rightarrow -\infty.$$

Let x_* be such that $u^0(x)$ lies in a $\delta/3$ -neighborhood of point $u_-^{\tau_0}$ for $x < x_*$. Recall that τ_0 is the value of τ for which $u^0(x)$ satisfies system (2.50) (for $i = 1, 2$, $u_-^{\tau_0} = u^-$). In a $\delta/2$ -neighborhood of point $u_-^{\tau_0}$ equations (2.50) take the form

$$(2.66) \quad du'' + cu' + \varepsilon(u_-^{\tau_0} - u) = 0.$$

For sufficiently large k and $x < x_*$, function $u_N^k(x)$ lies in a $\delta/2$ -neighborhood of point $u_-^{\tau_k}$, where τ_k is that value of τ for which $u_N^k(x)$ satisfies equation (2.50). This follows from the uniform convergence of $u_N^k(x)$ to $u^0(x)$ over the whole x -axis. Thus $u_N^k(x)$ is a solution of equation (2.66) for $\tau = \tau_k$. By virtue of (2.63) $u_{N_i}^k(x)$ is a constant for all $x < x_*$. This contradicts the strict monotonicity of function $u^0(x)$.

The contradiction obtained establishes the validity of the statement made at the beginning of this section concerning the existence of a number ρ such that inequality (2.52) is valid.

2.4.3. *A priori estimates.* Here we shall obtain a priori estimates of solutions of system (2.50), monotone with respect to x , and such that the corresponding functions $A(x)$ are positive. Monotonicity of the solutions implies boundedness in the C -norm. To obtain estimates in the space $W_{2,\mu}^1$ we need to obtain, as in Chapter 3, a priori estimates of the speed, uniform estimates of solutions in neighborhoods of points 0 and u^- , and also to prove that outside of these neighborhoods the solution is found on a uniformly bounded interval with respect to x . The question concerns

estimates, uniform with respect to τ , in the space $W_{2,\mu}^1$ for fixed (sufficiently small) $\varepsilon > 0$.

Uniform exponential estimates in neighborhoods of points 0 and u^- are obtained by the usual methods. They result from the fact that matrices obtained by linearization of the sources φ_τ^i at these points have eigenvalues with negative real parts.

Consider now the question concerning boundedness of the interval with respect to x on which the solution is found outside of these neighborhoods. Violation of such boundedness is only possible in case the solution “is attracted” to intermediate stationary points \bar{u} of a kinetic system (see Lemma 2.5 and Lemma 2.8 of Chapter 3). The latter means that corresponding trajectories of the first order system

$$w' = p, \quad ap' = -cp - F(w)$$

are attracted to the point $(\bar{u}, 0)$.

Stationary points of a kinetic system can be of two types:

1. Points at which

$$(2.67) \quad k_i(\theta) > 0 \quad (i = 1, \dots, n).$$

At these points $\Phi_i(u, \theta) = 0$ ($i = 1, \dots, n$). We note, by virtue of conditions (2.23), that inequality (2.67) is equivalent to the inequality

$$(2.68) \quad 0 \leq \theta < \theta^*.$$

In view of the notation (2.36), this means that we have the inequalities

$$(2.69) \quad 0 \leq (p, u) < \theta^*.$$

2. Points at which

$$(2.70) \quad k_i(\theta) = 0.$$

This applies when

$$(2.71) \quad (p, u) \geq \theta^*.$$

We consider stationary points of the first kind for which Condition 1 is satisfied (see §2.1). Let this be the point \bar{A} . We consider only the first homotopy step since at the remaining steps there are no intermediate stationary points of the first kind. We show that in the homotopy process solution $A(x)$ cannot be attracted to stationary point \bar{A} . Let us assume the contrary. Then there exists a sequence τ_k , and also a sequence of solutions $A^k(x)$ and a sequence of points x_k , such that

$$(2.72) \quad A^k(x_k) \rightarrow \bar{A}.$$

Here $A^k(x)$ is a solution of system (2.57) for $\tau = \tau_k$. Without loss of generality, we can assume that $\tau_k \rightarrow \tau_0$.

Consider the function

$$(2.73) \quad y^k(x) = (\mu, A^k(x) - \bar{A}),$$

where μ is a vector appearing in Condition 1. From (2.72) it follows that $y^k(x_k) \rightarrow 0$. Further, by virtue of Condition 1, we have

$$(\mu, A^+ - \bar{A}) > 0, \quad (\mu, A^- - \bar{A}) > 0.$$

Thus, letting $y_+ = y^k(+\infty)$, $y_- = y^k(-\infty)$, we have

$$(2.74) \quad y_+ > 0, \quad y_- > 0.$$

Consequently, for all sufficiently large k , functions $y^k(x)$ reach the smallest value at some finite point ξ_k . If this point is not one, we then understand ξ_k to be the point furthest to the left. By virtue of Condition 1, $y^k(\xi_k) \geq 0$ and therefore

$$(2.75) \quad y^k(\xi_k) \rightarrow 0.$$

Consider the sequence $A^k(\xi_k)$. Without loss of generality, we can assume it is convergent: $A^k(\xi_k) \rightarrow A^*$ as $k \rightarrow \infty$. Consequently, by virtue of (2.75) we have $(\mu, A^* - \bar{A}) = 0$, and, therefore, on the basis of Condition 1, point A^* belongs to a stationary face Π_0 . From (2.57) it follows that y^k is a solution of the equation

$$(2.76) \quad \begin{aligned} dy^{k''} + cy^{k'} + [\tau_k + (1 - \tau_k)\omega(|u_k|)] \mu \Gamma \Phi^\varepsilon(A^k, T^k) \\ + \varepsilon \omega(|u^- - u_k|)(y_- - y^k) = 0, \end{aligned}$$

where u_k corresponds to A^k . Noting that ξ_k is the left-most point of the minimum of function $y^k(x)$, we obtain a contradiction in signs in equation (2.76) since, by virtue of Condition 1, for sufficiently large k the source in it is negative. In fact, letting $z^k(x) = y^k(x) - y^k(\xi_k)$, $w(x) = (x - \xi)^2$, where $\xi < \xi_k$ and $\xi_k - \xi$ is sufficiently small, we obtain, upon multiplying (2.76) by w and integrating by parts,

$$\int_{\xi}^{\xi_k} [2d - 2c(x - \xi)] z^k(x) dx \leq 0.$$

This is not possible since $z^k(x) \geq 0$, $z^k(x) \not\equiv 0$. The contradiction obtained shows that when Condition 1 is satisfied solution $A(x)$ cannot be attracted to stationary point \bar{A} .

We consider stationary points of the second kind, i.e., points in which equation (2.70) is satisfied. We assume that the thermal effects q_i are positive (thermal effects of different signs will be considered below). Consider first the first homotopy step. If the solution is attracted to an intermediate stationary point, then there exist two solutions $u^{(1)}(x)$ and $u^{(2)}(x)$ of system (2.50) for $i = 1$, satisfying the following conditions at the infinities:

$$\begin{aligned} \lim_{x \rightarrow \infty} u^{(1)}(x) = \bar{u}^{(1)}, \quad \lim_{x \rightarrow -\infty} u^{(1)}(x) = u^-, \\ \lim_{x \rightarrow \infty} u^{(2)}(x) = 0, \quad \lim_{x \rightarrow -\infty} u^{(2)}(x) = \bar{u}^{(2)} \neq u^-, \end{aligned}$$

where $(p, \bar{u}^{(1)}) \geq \theta^*$. In view of the monotonicity of $u^{(1)}(x)$ and the positiveness of vector p , we have the inequality $(p, u^{(1)}(x)) \geq \theta^*$, from which it follows that $\varphi_\tau^1(u^{(1)}(x)) = 0$ for sufficiently large x , and we find, by virtue of Lemma 2.8 of Chapter 3, that $c > 0$. Similarly, considering solution $u^{(2)}(x)$, we obtain $c < 0$,

which leads to a contradiction. In the second and third steps of the homotopy we also arrive at a contradiction in signs of the speed on the basis of Lemma 2.8 of Chapter 3.

Thus, we have shown that when Condition 1 of §2.1 is satisfied, and assuming thermal effects to be positive, the interval with respect to x , outside of neighborhoods of points 0 and u^- , on which the solution is found is bounded.

A priori estimates of the speed can be obtained in a manner similar to that used in Chapter 3. But, for the case in question, this can be done more simply if we take into account the existence of a domain in the interval $[0, u^-]$, separating the points 0 and u^- , where the source $\varphi_\tau^i(u)$ vanishes identically. Indeed, let x_1 and x_2 be such that $|u^- - u(x_1)| = \delta$, $|u^- - u(x_2)| = \delta + \rho$, where ρ is chosen so that $\varphi_\tau^i(u) = 0$ for $\delta \leq |u^- - u| \leq \delta + \rho$. Then, by virtue of equation (2.50), we have

$$d|u'(x_2) - u'(x_1)| = |c||u(x_2) - u(x_1)| \geq |c|\rho.$$

From this and from a priori estimates of derivatives (see Lemma 2.1 of Chapter 3) we obtain an estimate of the speed c .

Thus, under the indicated assumptions, we have obtained an a priori estimate of monotone solutions of system (2.50) to which there correspond positive A .

2.4.4. *Existence of waves.* To prove existence of a solution of system (2.19) with boundary conditions (2.21), we first carry out such a proof for the system (2.28), (2.29) with the modified source, and we then pass to the limit with $\varepsilon \rightarrow 0$.

To prove existence of a solution of system (2.28), (2.29) with conditions (2.21) at the infinities, we apply the Leray-Schauder method, carrying out the previously described homotopy (§2.4.1).

Consider system (2.50) for $\tau = 0$, $i = 3$:

$$(2.77) \quad \begin{aligned} du'' + cu' - \omega(|u|)u + \varepsilon\omega(|u_-^0 - u|)(u_-^0 - u) &= 0, \\ u(+\infty) = 0, \quad u(-\infty) &= u_-^0. \end{aligned}$$

The obtained model system differs from that presented in Chapter 3, and we therefore treat it independently. A solution of this system has the form

$$(2.78) \quad u(x) = y(x)u_-^0,$$

where $y(x)$ is a scalar function satisfying the equation

$$(2.79) \quad \begin{aligned} dy'' + cy' - \omega(|u_-^0||y|)y + \varepsilon\omega(|u_-^0||1 - y|)(1 - y) &= 0, \\ y(+\infty) = 0, \quad y(-\infty) &= 1. \end{aligned}$$

As is well known (see [Kan 3, Fife 7] and Chapter 1), a monotone solution of such an equation exists and is unique. Thus, a solution of system (2.77) exists. Its monotonicity follows from (2.78). We show that a monotone solution of system (2.77) is unique. Indeed, let $u(x)$ be an arbitrary smooth solution of this system. Let $v_i = u_i/u_-^0$. Then v_i satisfies the equation

$$(2.80) \quad \begin{aligned} dv_i'' + cv_i' - \omega(|u(x)|)v_i + \varepsilon\omega(|u_-^0 - u(x)|)(1 - v_i) &= 0, \\ v_i(+\infty) = 0, \quad v_i(-\infty) &= 1. \end{aligned}$$

In view of the uniqueness of a solution of such a problem, all the $v_i(x)$ coincide with one another, and, therefore, $v_i(x) = y(x)$, and $u(x)$ has the form (2.78).

System (2.77), linearized on the solution obtained, satisfies the condition for Theorem 5.1 of Chapter 4. From this, as in Chapter 3, we find that a rotation of the vector field of the operator corresponding to system (2.77) over a sufficiently small ball with center at the stationary point considered is equal to one.

Function $A(x)$ corresponding to the acquired solution $u(x)$ of system (2.77) is positive. By virtue of equation (2.48), for $\tau = 0$ we have $u(x) = \tilde{A}(x)$. Positiveness of $\tilde{A}(x)$ follows from system (2.59) in view of the fact that $\tilde{A}(x)$ is positive in a δ -neighborhood of points 0 and u^0 and outside of these neighborhoods the source vanishes and the solution is found explicitly.

Thus we have constructed a domain containing all monotone solutions of system (2.50) (more precisely, stationary points of the corresponding operator) to which there correspond positive $A(x)$. This domain contains no solutions not satisfying the indicated conditions. A rotation of the vector field over the boundary of this domain is equal to unity. Advancing with respect to parameter τ and carrying out constructions similar to those in Chapter 3, we obtain for the initial system, using a separation of solutions monotone with respect to u and positive with respect to A , a finite collection of domains containing all solutions of the type indicated above and containing no other solutions. A rotation of the vector field over the boundary of this collection of domains is equal to unity. Existence of solutions of the initial system that are monotone with respect to u and positive with respect to A follows from this.

We have considered system (2.28), (2.29) for arbitrary sufficiently small $\varepsilon > 0$. It remains now to take the limit as $\varepsilon \rightarrow 0$. We note that for solutions of this system there are a priori estimates in the C -norm, uniform with respect to ε , since $u(x)$ is monotone. Uniform estimates in the C^1 -norm (see §2 of Chapter 3) follow from this, as well as uniform estimates of the speed (see §2.4.3). As in §2.4.3 it may be proved that solutions cannot be attracted to intermediate stationary points. Therefore, considering trajectories of the corresponding first order system of equations, we conclude that there exists a limiting trajectory joining the stationary points $(0, 0)$ and $(u^-, 0)$. Thus we have proved the existence of monotone solutions of system (2.19) with conditions (2.21), to which there correspond positive A .

2.5. Additions to the theorem.

2.5.1. *Thermal effects of different signs.* In the theorem we considered the case in which thermal effects were positive, i.e., $q = (q_1, \dots, q_n) > 0$. If these effects were of different signs, then to obtain a priori estimates and to apply the Leray-Schauder method we need to impose an additional condition, which we present below.

If vector q is not positive, then, in general, vector p is also not positive; this vector is a solution of equation (2.27) and specifies a relationship between temperature and concentrations in a wave: $\theta(x) = (p, u(x))$. Therefore, if for positive thermal effects the temperature in the wave is monotone by virtue of monotonicity of $u(x)$, this can then not be the case for thermal effects of different signs.

Multiplying equation (2.28) by p , we obtain an equation for $\theta(x)$:

$$\begin{aligned} d\theta'' + c\theta' - (q, \Phi) + \varepsilon\omega(|u^- - u|)(1 - \theta) &= 0, \\ \theta(-\infty) &= 1, \quad \theta(+\infty) = 0, \end{aligned}$$

where $(q, \Phi) = 0$ for $\theta \geq \theta^*$ and, by assumption, a δ -neighborhood of point u^- lies

in the half-space $(p, u) > \theta^*$. Therefore, by virtue of the equation, $\theta(x) \leq 1$ for all x .

We require that a positive number ε_1 exist such that the following inequality is satisfied:

$$(q, \Phi(u, \theta)) > 0 \quad \text{for } \theta^* - \varepsilon \leq (p, u) < \theta^*,$$

where $\theta = (p, u)$. Then, as is readily seen from the equation, function $\theta(x)$ is monotone for $\theta \geq \theta^* - \varepsilon_1$. Similarly, it may be verified that this function is monotone in this half-space in the entire homotopy process. Therefore, as was also the case for positive thermal effects, the assumption that a solution is attracted to an intermediate stationary point lying in the domain $(p, u) \geq \theta^*$ leads to a contradiction in signs of the speed. In all other respects, the proof of existence of solutions is carried out exactly as before.

2.5.2. *Magnitude of cut-off of the source.* It is well known that for stage combustion processes a wave may not exist; instead, a collection of waves propagating with various speeds can appear (see the supplement to Part III). This does not contradict the theorem for the existence of waves, already proved. This noncorrespondence is associated with the presence of various time scales in which a process is considered. In a number of cases the time for approach to a wave can be so large that for a real process one cannot speak about the existence of a wave. Therefore, a more precise description of a process can be obtained by changing somewhat a premise concerning the source.

We consider, as an example, two independent reactions:

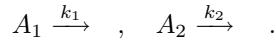

We shall assume, in contrast to the case considered in the theorem, that the functions $k_i(\theta)$ vanish, generally speaking, for different temperatures $\theta = \theta_i$. The system of equations for determination of a wave can be written in the form

$$(2.81) \quad du_1'' + cu_1' - k_1(\theta)u_1 + \varepsilon\omega(|u^- - u|)(u_1^- - u_1) = 0,$$

$$(2.82) \quad du_2'' + cu_2' - k_2(\theta)u_2 + \varepsilon\omega(|u^- - u|)(u_2^- - u_2) = 0,$$

$$(2.83) \quad u(-\infty) = u^-, \quad u(+\infty) = 0,$$

where $\theta = p_1u_1 + p_2u_2$, and p_i are positive constants. We assume, for simplicity, that $u^- = (1, 1)$.

Let us assume, for definiteness, that $\theta_2 \leq \theta_1$ and let us find the stationary points of the kinetic system in the half-plane $(p, u) < \theta_1$, different from $u = 0$ and belonging to the interval $[0, u^-]$. It is obvious that they must belong to the line $u_1 = 0$ and lie in the half-plane $(p, u) \geq \theta_2$. Thus, if $p_2 < \theta_2$, then there are no such points. If $\theta_2 \leq p_2 < \theta_1$, then these points fill out the interval $[\theta_2/p_2, 1]$ on the axis of ordinates. If $p_2 \geq \theta_1$, they then fill out the half-interval $[\theta_2/p_2, \theta_1/p_1]$ on this same axis.

In case $p_2 < \theta_2$ or $p_2 \geq \theta_1$, a solution of system (2.81), (2.82) with the boundary conditions (2.83) always exists. To prove this, we construct a homotopy of function $k_1^\tau(\theta)$ in such a way that when $\tau = 0$ it coincides with $k_1(\theta)$ and vanishes for $\theta = \theta_1^\tau$, where $\theta_1^\tau = \tau\theta_2 + (1 - \tau)\theta_1$, $0 \leq \tau \leq 1$. A priori estimates of monotone solutions can be obtained here, as was done in the proof of the theorem.

Let $\theta_1 > p_2 \geq \theta_2$. In this case there exist solutions of system (2.81), (2.82) of the form

$$\begin{aligned} u_1(x) &\equiv \bar{u}_1(x), & u_2(x) &\equiv 1, & u_1(-\infty) &= 1, & u_1(+\infty) &= 0, \\ u_1(x) &\equiv 0, & u_2(x) &\equiv \bar{u}_2(x), & u_2(-\infty) &= 1, & u_2(+\infty) &= 0. \end{aligned}$$

Here $\bar{u}_i(x)$, $i = 1, 2$, are waves described by the corresponding scalar equation. We denote their speeds by c_1 and c_2 , respectively. We note that for $p_2 = \theta_2$ the solution $\bar{u}_2(x)$ is not unique: such solutions exist for all $c \leq c_2$, where, in the given case, wavespeed c_2 is minimal in absolute value ($c_2 < 0$). For $\varepsilon = 0$, $c_1 < 0$. For small positive ε speed c_1 changes very little, and, in what follows, the dependence of c_1 on ε will, for simplicity of exposition, not be taken into account.

We show that for $c_2 < c_1$ there exists a wave satisfying conditions (2.83). To do this, we carry out the homotopy of function k_1^τ , described above, with the additional assumption that $k_1^\tau(\theta) \leq k_1(\theta)$ for $0 \leq \tau \leq 1$. It is easy to verify here that if the wave \bar{u}_1^τ exists, then its speed satisfies the inequality $c_1^\tau \geq c_1$. We need to show that in the homotopy process the solution cannot be attracted to intermediate points filling out the interval $[\theta_2/p_2, 1]$ of the axis of ordinates. (Otherwise, proof for the existence of a wave does not change.) If this assertion does not hold, then for some τ and c there exist solutions $v^{(1)}(x)$ and $v^{(2)}(x)$ of system (2.81), (2.82) for which $v^{(1)}(-\infty) = u^-$, $v^{(1)}(+\infty) = \bar{v}^{(1)}$, $v^{(2)}(-\infty) = \bar{v}^{(2)}$, $v^{(2)}(+\infty) = 0$, where points $\bar{v}^{(i)}$, $i = 1, 2$, belong to the indicated interval. We can show that $\bar{v}^{(1)} = \bar{v}^{(2)}$. Indeed, if this is not the case and $\bar{v}_2^{(2)} < \bar{v}_2^{(1)}$, then for a sequence of prelimiting solutions $u^{(k)}(x)$ there exist sequences $x_k^{(1)}$ and $x_k^{(2)}$, for which

$$u^{(k)}(x_k^{(i)}) \rightarrow \bar{v}^{(i)}, \quad u^{(k)'}(x_k^{(i)}) \rightarrow 0.$$

(If $\bar{v}_2^{(2)} = \theta_2/p_2$, then, instead of the point $\bar{v}^{(2)}$, it is better to consider the point $0.5(\bar{v}^{(1)} + \bar{v}^{(2)})$ for which such a sequence of values x also exists.) Since $(p, u^{(k)}(x_k^{(i)})) > \theta_2$ for large k , it then follows from equation (2.82) that

$$d[u_2^{(k)'}(x_k^{(2)}) - u_2^{(k)'}(x_k^{(1)})] + c[u_2^{(k)}(x_k^{(2)}) - u_2^{(k)}(x_k^{(1)})] = 0,$$

which leads to a contradiction as $k \rightarrow \infty$ ($c \neq 0$). Thus we have shown that $\bar{v}^{(1)} = \bar{v}^{(2)}$.

From the inequality $c_1^\tau > c_2$ it follows that $\bar{v}^{(1)}$ cannot coincide with the point $(0, 1)$ (otherwise, $c_1^\tau = c_2$). If $\bar{v}^{(1)}$ coincides with some other point of the interval $[\theta_2/p_2, 1]$ of the axis of ordinates, then from equation (2.82) and Lemma 2.6 of Chapter 3, for the solution $v^{(1)}(x)$ we find that $c > 0$, and for the solution $v^{(2)}(x)$ we find that $c < 0$. The resulting contradiction shows that the solution cannot be attracted to stationary points on the axis of ordinates. The remaining part of the proof of the existence of waves is the same.

Further, we can show that for $c_2 \geq c_1$ no monotone solution of system (2.81), (2.82) with the conditions (2.83) exists. Without going into the details of the proof, we merely indicate its general nature. If the solution indicated above exists, it is then sufficient to construct a homotopy, in the process of which it cannot disappear

and which converts the initial system into a model system for which such solutions do not exist. As such a homotopy, we can take a homotopy $k_2^\tau(\theta)$, for which

$$k_2^0(\theta) \equiv k_2(\theta), \quad k_2^\tau(\theta) \leq k_2(\theta)$$

and the value of θ_2^τ , for which the function k_2^τ vanishes, decreases monotonically. Then $c_2^\tau > c_2 \geq c_1$ for $\tau > 0$.

Let F_i^τ denote a nonlinear source in the equation for $u_i^\tau(x)$. It is readily verified that for sufficiently small ε we have the estimate

$$\int_0^1 F_1^\tau(u_1, u_2(u_1)) du_1 < -m_1$$

for an arbitrary monotone function $u_2(u_1)$ ($u_2(0) = 0, u_2(1) = 1$), where m_1 is a positive constant ($F_1^\tau \equiv F_1$). By virtue of the estimate

$$\int_{+\infty}^{-\infty} [u_1^{\tau'}(x)]^2 dx \leq m_2,$$

where m_2 is a constant which estimates $|u_1^{\tau'}(x)|$ from above (Lemma 2.1 of Chapter 3), we obtain an estimate of the speed c_τ independent of τ : $c_\tau \leq -m_1/m_2$ (Lemma 2.6 of Chapter 3). On the other hand, for $\sigma > 0$ arbitrarily small, for sufficiently small θ_2^τ , we have

$$\int_0^1 F_2^\tau(u_1(u_2), u_2) du_2 \geq -\sigma$$

for an arbitrary monotone function $u_1(u_2)$ ($u_1(0) = 0, u_1(1) = 1$). In a domain where function F_2^τ is identically zero, equation (2.82) may be solved explicitly, which makes it possible, upon taking into account the acquired estimate from above of the speed c_τ , to obtain the estimate

$$\int_{-\infty}^{+\infty} [u_2^{\tau'}(x)]^2 dx \geq k,$$

where k is a positive constant independent of τ . By virtue of Lemma 2.6 of Chapter 3 we obtain an estimate of speed $c_\tau \geq -\sigma/k$, which, for small σ , leads to a contradiction with the estimate obtained earlier.

We have thus shown that for $c_2 \geq c_1$ a monotone wave cannot exist.

Above we have considered the case $\theta_2 \leq \theta_1$. If $\theta_2 > \theta_1$ and $\theta_1 \leq p_1 < \theta_2$, then there exist solutions of system (2.81), (2.82) of the form

$$\begin{aligned} u_1(x) &\equiv 1, & u_2(x) &\equiv \bar{u}_3(x), & u_2(-\infty) &= 1, & u_2(+\infty) &= 0, \\ u_1(x) &\equiv \bar{u}_4(x), & u_2(x) &\equiv 0, & u_1(-\infty) &= 1, & u_1(+\infty) &= 0. \end{aligned}$$

Here $\bar{u}_i(x)$, $i = 3, 4$, are waves described by the corresponding scalar equation. We denote their speeds by c_3 and c_4 , respectively.

As was done above, it can be proved that for $c_3 > c_4$ a monotone solution of system (2.81), (2.82) with conditions (2.83) exists; for $c_3 \leq c_4$ such a solution does not exist.

We return now to a discussion of various interpretations of the existence of a wave. We note that Arrhenius temperature dependencies are often taken as the functions $k_i(\theta)$. For large activation energies behavior of the process depends weakly on the size of the cut-off in the source. Therefore, in a mathematical model

the size of the cut-off can be specified to a sufficient degree arbitrarily and the result will depend on this weakly. Thus, if in the example considered above we have $c_2 > c_1$ and $\theta_2 < p_2 < \theta_1$, then a wave with the conditions (2.83) does not exist. If $\theta_1 = \theta_2 > p_2$ exists, but the corresponding trajectories of the system

$$w' = p, \quad ap' = -cp - F(w)$$

pass close to the singular point $u = (0, 1)$, $p = (0, 0)$, then the distance between localized zones of the reaction is so large that in real time it is not the propagation of one wave that is observed, but the propagation of two waves with speeds c_1 and c_2 .

If we consider a wave as an intermediate asymptotics for a source without cut-off [Baren 4], then for the latter the same conclusions remain valid in the example considered: if $c_2 \geq c_1$ or $c_4 \geq c_3$, then a wave with the conditions (2.83) does not exist. If $c_2 < c_1$ and $c_4 < c_3$, then such a wave does exist. These conclusions are in agreement with known results for combustion processes.

2.6. Existence of waves in the absence of equality of transport coefficients. Here we establish the existence of waves, i.e., solutions of system (2.19) with boundary conditions (2.21), without assuming that $\varkappa = d$. In the proof we employ the Leray-Schauder method, wherein we apply a homotopy to the system in which $\varkappa = d$ and then make use of the results of the preceding section.

2.6.1. *Homotopy.* The homotopy will be carried out in three steps. First we consider ε positive and sufficiently small. This is then followed by a limiting approach with $\varepsilon \rightarrow 0$.

First step. System (2.28), (2.29) is reduced to a system with $\varkappa = d$. The homotopy has the form

$$(2.84) \quad du'' + cu' + f(u, \theta) = 0,$$

$$(2.85) \quad \varkappa_\tau \theta'' + c\theta' + g(u, \theta) = 0,$$

where f and g are given by equations (2.30), (2.31), $\varkappa_\tau = (1 - \tau)d + \tau\varkappa$, $0 \leq \tau \leq 1$.

Second step. In function $f(u, \theta)$ we replace θ by $\tau\theta + (1 - \tau)(p, u)$. The system takes the form

$$(2.86) \quad du'' + cu' + f^\tau(u, \theta) = 0,$$

$$(2.87) \quad d\theta'' + c\theta' + g^\tau(u, \theta) = 0,$$

where

$$f^\tau(u, \theta) = f(u, \tau\theta + (1 - \tau)(p, u)),$$

$$g^\tau(u, \theta) = (p, f^\tau(u, \theta)) - \varepsilon\theta + \varepsilon(p, u).$$

For $\tau = 0$ we have the system (see (2.33)):

$$(2.88) \quad du'' + cu' + \varphi(u) = 0,$$

$$(2.89) \quad d\theta'' + c\theta' + g^0(u, \theta) = 0,$$

where

$$(2.90) \quad g^0(u, \theta) = (p, \varphi(u)) - \varepsilon\theta + \varepsilon(p, u),$$

with the conditions

$$(2.91) \quad u(+\infty) = 0, \quad u(-\infty) = u^-,$$

$$(2.92) \quad \theta(+\infty) = 0, \quad \theta(-\infty) = 1.$$

As a result of the homotopy, we have arrived at system (2.88) considered in §2.4, independent of θ , and at equation (2.89) for θ .

Third step. We carry out a homotopy of system (2.88) in exactly the same way as was done in §2.4.1. All three steps of the homotopy, described therein, are presented in the form (2.50), (2.51). In accordance with this, we have the system

$$(2.93) \quad du'' + cu' + \varphi_\tau^i(u) = 0 \quad (i = 1, 2, 3; \quad 0 \leq \tau \leq 1),$$

$$(2.94) \quad d\theta'' + c\theta' + g_\tau^i(u) = 0,$$

where

$$(2.95) \quad g_\tau^i(u) = (p, \varphi_\tau^i(u)) - \varepsilon\theta + \varepsilon(p, u),$$

with the conditions

$$(2.96) \quad u(+\infty) = 0, \quad u(-\infty) = u_-^{i,\tau},$$

$$(2.97) \quad \theta(+\infty) = 0, \quad \theta(-\infty) = (p, u_-^{i,\tau}).$$

We note that equation (2.94) for u , substituted from (2.93), is linear with respect to θ . At the second and third steps of the homotopy we have

$$(2.98) \quad \theta(x) = (p, u(x)).$$

2.6.2. *Model system.* As a result of the homotopy we have arrived at system (2.93), (2.94) for $i = 3, \tau = 0$. It has the form

$$(2.99) \quad du'' + cu' + \varphi_0^3(u) = 0,$$

$$(2.100) \quad d\theta'' + c\theta' + (p, \varphi_0^3(u)) - \varepsilon\theta + \varepsilon(p, u) = 0,$$

where $\varphi_0^3(u)$ is given by equation (2.49) with the conditions

$$(2.101) \quad u(+\infty) = 0, \quad u(-\infty) = u_-^0,$$

$$(2.102) \quad \theta(+\infty) = 0, \quad \theta(-\infty) = (p, u_-^0).$$

As was shown in §2.4.4, problem (2.99), (2.101) has a unique monotone solution $u(x)$ to which there corresponds a positive $A(x)$. The solution of problem (2.100), (2.102) is obtained from formula (2.98). Thus, problem (2.99)–(2.102) has a unique solution, monotone with respect to x , to which there corresponds a positive $A(x)$. We note, in view of the positiveness of vector p , that function $\theta(x)$ given by equation (2.98) is also monotone.

Consider the spectrum of the corresponding linearized problem

$$(2.103) \quad d\tilde{u}'' + c\tilde{u}' + B(x)\tilde{u} = \lambda\tilde{u}, \quad \tilde{u}(\pm\infty) = 0,$$

$$(2.104) \quad d\tilde{\theta}'' + c\tilde{\theta}' + (p, B(x)\tilde{u}) - \varepsilon\tilde{\theta} + \varepsilon(p, \tilde{u}) = \lambda\tilde{\theta}, \quad \tilde{\theta}(\pm\infty) = 0,$$

where

$$B(x) = [\varphi_0^3(u(x))]'_u.$$

We note that the matrices, obtained by linearization of the source, have, in the limit

as $x \rightarrow \pm\infty$, all eigenvalues with negative real part. Therefore, problem (2.103), (2.104) has, in the half-plane $\text{Re } \lambda \geq 0$, a discrete spectrum. Further, it follows from (2.103), (2.104) that function $z = \tilde{\theta} - (p, \tilde{u})$ satisfies the equation

$$dz'' + cz' - \varepsilon z = \lambda z, \quad z(\pm\infty) = 0.$$

For $\text{Re } \lambda \geq 0$ we obtain $z(x) \equiv 0$, i.e.,

$$(2.105) \quad \tilde{\theta}(x) = (p, \tilde{u}(x)).$$

Since system (2.103) has only the zero solution for $\lambda > 0$, and the value $\lambda = 0$ is a simple eigenvalue of the system (see Theorem 5.1 of Chapter 4), then, by virtue of equation (2.105), the same can also be said for the system (2.103), (2.104). (The absence of associated vectors in problem (2.103), (2.104) of $\lambda = 0$ follows, as can readily be shown, from the fact of their absence in problem (2.103).)

The indicated properties of the model system will be used in calculating a rotation of the vector field at the initial point of the homotopy.

2.6.3. *A priori estimates.* We now obtain a priori estimates of solutions of the system of equations for u and θ , constructed in §2.6.1, at all steps of the homotopy. Here we consider solutions $v(x) = (u(x), \theta(x))$, for which the $u(x)$ are monotone functions, the corresponding $A(x)$ are positive, and are such that the temperature $\theta(x)$ at the first homotopy step is a monotone function of x for those values of x for which $|u(x)| \geq \delta$, $|u(x) - u^-|^2 + |\theta(x) - 1|^2 \geq \delta^2$. We denote the set of all such solutions $v(x)$ by V_M . We note that, by virtue of equation (2.98), which holds at the second and third steps of the homotopy, function $\theta(x)$ is monotone on the whole axis if $u(x)$ is monotone.

We note, further, that the initial equation for θ has the form (2.19) when $\varepsilon = 0$. For positive thermal effects q_i and positive $A(x)$ the solution of this equation with condition (2.21) is monotone in view of the nonnegativeness of function (q, Φ) , and, consequently, satisfies the condition

$$(2.106) \quad 0 \leq \theta(x) \leq 1.$$

Therefore, outside of the interval $[0, 1]$, the values of the functions $k_i(\theta)$ can be specified arbitrarily. We shall assume that functions $k_i(\theta)$ are specified so as to satisfy the condition

$$(2.107) \quad k_i(\theta) = 0 \quad \text{for } \theta < -1 \quad (i = 1, \dots, n).$$

LEMMA 2.2. *At the first homotopy step we have the following estimate for all τ and ε for $v \in V_M$:*

$$|\theta(x)| \leq 1.$$

PROOF. Let us assume that $\theta(x) > 1$ for some x . Let function $\theta(x)$ attain a maximum at point x_0 . Then at this point $\theta''(x_0) \leq 0$, $\theta'(x_0) = 0$; also, by virtue of equation (2.31),

$$\begin{aligned} g(u, \theta) &\leq \varepsilon\omega(|u^- - u|)(p, u^- - u) - \varepsilon\theta + \varepsilon(p, u) \\ &\leq \varepsilon(p, u^-) - \varepsilon\theta = \varepsilon(1 - \theta) < 0. \end{aligned}$$

A contradiction in signs is obtained in equation (2.29).

Let us assume that $\theta(x) < -1$, and let x_1 be a point at which $\theta(x)$ attains its smallest value. At this point $g(u, \theta) = \varepsilon\omega(|u^- - u|)(p, u^- - u) - \varepsilon\theta + \varepsilon(p, u) \geq -\varepsilon\theta >$

ε , $\theta''(x_1) \geq 0$, $\theta'(x_1) = 0$, and we have a contradiction in signs in equation (2.29). This completes the proof of the lemma. \square

Thus we have shown that for all $v \in V_M$ there is a uniform estimate in the C -norm, independent of ε . As was the case earlier (see §2 of Chapter 3), this implies a uniform estimate in the C^1 -norm, and also a uniform estimate of the speed (see §2.4.3).

We proceed now to an estimate of solutions $v \in V_M$ in the norm of $W_{2,\mu}^1$ for fixed ε , sufficiently small.

Uniform exponential estimates in neighborhoods of the points

$$u = 0, \quad \theta = 0; \quad u = u_-^{i,\tau}, \quad \theta = (p, u_-^{i,\tau})$$

are obtained by the usual methods. These estimates result from the fact that in linearizing sources at these points matrices are obtained whose eigenvalues have negative real parts.

As in §2.4.3, we consider the problem concerning boundedness of the interval in x on which a solution is obtained outside of these neighborhoods. Violation of such boundedness is only possible in case the solution is attracted to intermediate stationary points of the kinetic system. Here we need to consider only the first homotopy step. Indeed, at the third step estimates of $u - \psi$ in the norm of $W_{2,\mu}^1$ have already been obtained, while, for θ , an estimate of the difference $\theta - (p, \psi)$ follows from equation (2.98). At the second step of the homotopy no further estimates are needed.

Thus, we consider stationary points of a kinetic system at the first step of homotopy, which, obviously, coincide with stationary points of the initial kinetic system:

$$(2.108) \quad f(u, \theta) = 0, \quad g(u, \theta) = 0,$$

where f and g are given by equations (2.30) and (2.31).

It is easy to see that all solutions of equation (2.108), lying in the interval $0 \leq u \leq u^-$, satisfy the equation $\theta = (p, u)$ and have the form

$$(2.109) \quad u = 0, \quad \theta = 0,$$

$$(2.110) \quad u = u^-, \quad \theta = 1,$$

$$(2.111) \quad |u^- - u| \geq \delta, \quad \theta = (p, u) \text{ for } (p, u) \geq \theta^*,$$

$$(2.112) \quad \Phi^\varepsilon(u, \theta) = 0, \quad \theta = (p, u) \text{ for } 0 < (p, u) < \theta^*.$$

Here we assume that δ is chosen so small that the plane $(p, u) = \theta^*$ in u -space lies outside of the balls $|u^- - u| \leq \delta$, $|u| \leq \delta$.

In a manner similar to what was done in §2.4.3, it may be shown, upon taking monotonicity of $\theta(x)$ into account in the domain indicated above, that the solution cannot be attracted to the stationary points (2.111) and (2.112). Here, in the course of the proof, one must consider, instead of the sequence $A^k(\xi_k)$, the sequence $A^k(\xi_k)$, $\theta^k(\xi_k)$, which, as is readily seen, converges to a stationary point.

Thus we have obtained an a priori estimate for $v \in V_M$ for each fixed, sufficiently small $\varepsilon > 0$ and for all $0 \leq \tau \leq 1$ for all steps of the homotopy:

$$(2.113) \quad \|v - \psi\|_\mu \leq R(\varepsilon),$$

where the constant R is independent of v , and ψ is chosen as in §1 of Chapter 2

with the equation $\theta = (p, u)$ taken into account at the second and third steps of the homotopy.

2.6.4. *Separation of monotone solutions.* We show that there exists a constant $\rho(\varepsilon)$, depending on ε , and such that the following inequality holds:

$$(2.114) \quad \|v_M - v_N\|_\mu \geq \rho(\varepsilon)$$

for all sufficiently small $\varepsilon > 0$. Here $v_M \in V_M^\varepsilon$, where V_M^ε is the set of solutions $v(x) = (u(x), \theta(x))$ for a given ε , indicated in the preceding section (we confine ourselves to the first step of the homotopy); $v_N(x)$ is an arbitrary solution of system (2.84), (2.85) for a given ε , not belonging to V_M^ε . We denote the set of all such solutions by V_N^ε . We remark that, as in §2.4.2, v_M and v_N can be different solutions of the indicated equations.

The set V_M^ε is not empty: as we shall show below, for $\tau = 0$ we obtain existence of solutions of this class as the result of a homotopy in the third and second steps, starting with a model system. The set V_N is assumed to be nonempty. Otherwise, the discussion only becomes simpler: there is no need to carry out the indicated separation.

Let us assume that the statement formulated above is not true. Then there exists a sequence $\varepsilon_n \rightarrow 0$ and, for arbitrary ε_n , sequences $v_M^{nk} \in V_M^{\varepsilon_n}$ and $v_N^{nk} \in V_N^{\varepsilon_n}$ and also sequences τ_{nk} and $\bar{\tau}_{nk}$ (whereby we can assume that $\tau_{nk} \rightarrow \tau_{n0}$ as $k \rightarrow \infty$) such that

$$(2.115) \quad \|v_M^{nk} - v_N^{nk}\|_\mu \rightarrow 0.$$

Here solutions v_M^{nk} correspond to τ_{nk} ; v_N^{nk} correspond to $\bar{\tau}_{nk}$. We can assume, by virtue of boundedness of speeds, that $c_{nk} \rightarrow c^{n0}$, where c_{nk} corresponds to τ_{nk} . It follows from estimate (2.113) that $v_M^{nk} - \psi$ converges weakly to some $v^{n0} - \psi \in W_{2,\mu}^1$ (we pass, if necessary, to subsequences). Reasoning as we did in §2.4.2, we find that

$$(2.116) \quad \|v_M^{nk} - v^{n0}\|_\mu \rightarrow 0$$

as $k \rightarrow \infty$. Hence, since $v_M^{nk} = (u_M^{nk}, \theta_M^{nk})$ is a solution of system (2.84), (2.85) and there are a priori estimates (uniform with respect to τ) of the first (see §2.4.3) and, consequently, of the second derivatives, it follows that $v_M^{nk} \rightarrow v^{n0}$ in C^1 . Thus $v^{n0} = (u^{n0}, \theta^{n0})$ is a solution of system (2.84), (2.85) for $\tau = \tau_{n0}$, $c = c^{n0}$.

From (2.115), (2.116) it follows that

$$(2.117) \quad \|v_N^{nk} - v^{n0}\|_\mu \rightarrow 0.$$

Therefore $v_N^{nk} \rightarrow v^{n0}$ in the C -norm and therefore in the C^1 -norm. As in §2.4.2, it may be shown that function $u^{n0}(x)$ is strictly monotone, and the function $A^{n0}(x)$, corresponding to it, is strictly positive; also, it may be shown that function u_N^{nk} , where $v_N^{nk} = (u_N^{nk}, \theta_N^{nk})$, is strictly monotone for sufficiently large k , and the function $A_N^{nk}(x)$, corresponding to it, is strictly positive. Hence, it follows from the definition of set V_N^ε that function $\theta_N^{nk}(x)$ is not monotone for those x for which

$$|u_N^{nk}(x)| \geq \delta, \quad |u_N^{nk}(x) - u^-|^2 + (\theta_N^{nk}(x) - 1)^2 \geq \delta^2.$$

On the other hand, $\theta^{n0}(x)$ is monotone in the corresponding domain as the limit of monotone functions $\theta_M^{nk}(x)$. It follows that the function $\theta^{n0}(x)$ is not strictly monotone. Letting n tend to infinity, we obtain a contradiction. Indeed, it is not difficult to show that here v^{n0} converges along some sequence to the solution

$v^0 = (u^0, \theta^0)$ of problem (2.84), (2.85) with boundary conditions (2.21) for some $\tau = \tau_0$, $\varepsilon = 0$, and $c = c^0 < 0$. Since the source $g(u, \theta)$ in equation (2.85) is not positive for $\varepsilon = 0$, it follows that $\theta^0(x)$ is a strictly monotone function. On the other hand, $\theta^0(x)$ is the limit in the C^1 -norm of functions $\theta^{n_0}(x)$, not strictly monotone outside of the neighborhoods indicated above, and it cannot therefore be strictly monotone. This contradiction establishes the assertion made at the beginning of this section.

2.6.5. Application of the Leray-Schauder method. We assume $\varepsilon > 0$ to be so small that inequality (2.114) is valid. Diminishing $\rho(\varepsilon)$, if necessary, we can assume that we do have the separation of monotone solutions obtained in §2.4.2. The discussion we follow now parallels that presented in §2.4.4. For a model system (§2.6.2) we construct an operator according to the method indicated in §1 of Chapter 2 and a ball, with center at a stationary point, of sufficiently small radius. A rotation over the boundary of this ball is equal to one. Next, we change τ from 0 to 1 in the third step of the homotopy (§2.6.1). We thereby construct domains, similar to those obtained in §2 of Chapter 3, using the separation of solutions, monotone with respect to u and positive with respect to A that was obtained in §2.4.2. Since equation (2.98) is satisfied here, there correspond monotone $\theta(x)$ to monotone $u(x)$. For $\tau = 1$ we arrive at a finite collection of domains D in the space $W_{2,\mu}^1$, containing solutions monotone with respect to θ and u and positive with respect to A , and containing no other solutions. A rotation over the boundary of these domains is equal to one and, therefore, there exist solutions of the type indicated.

Next, we go through the second step of the homotopy from $\tau = 0$ to $\tau = 1$, without changing domain D . What we said about this domain above holds by virtue of equation (2.98). Finally, using separation of monotone solutions obtained in §2.6.4, we perform the first step of the homotopy from $\tau = 0$ to $\tau = 1$, constructing domains separating solutions from V_M from other solutions, starting from domain D with $\tau = 0$. For $\tau = 1$ we obtain a domain, a rotation over which is equal to one, implying the existence of solutions from V_M^ε for system (2.28), (2.29) with boundary conditions (2.21).

To complete the proof of the existence of solutions of the initial system (2.19), we take the limit as $\varepsilon \rightarrow 0$. The arguments are analogous to those presented in §2.4.4.

§3. Stability of a wave in the case of equality of transport coefficients

In the preceding section we established the existence of a wave for a reaction-diffusion system for a reaction with an open graph, i.e., for the scheme of reactions (1.1) for which a solution of inequalities (1.10) exists. In this section we prove the stability of waves in the case of reactions with open graphs under certain assumptions, to be formulated below. We assume the existence of a wave, however, not necessarily under the conditions formulated in §2.

3.1. Reduction to a monotone system. We consider system (1.2) under the assumption that $\varkappa = d$ and $q > 0$, with boundary conditions (1.4). In these conditions A^+ , T^+ is an asymptotically stable stationary point of system (1.5). As we did above, we assume that substances are numbered so that $\widehat{A} = (A_1, \dots, A_r) = 0$ at this point and that equation (2.7) holds. As in §2.1, we can prove that openness of the graph of a reaction implies the existence of a noninvertible nonnegative matrix

B , such that equation (2.12) holds with $K \geq 0$. Making the substitution (2.17), we obtain system (2.19). Taking into account that $\varkappa = d$, we can express θ in terms of u (see (2.36)) and reduce system (2.19) to the form

$$(3.1) \quad du'' + cu' - K\Phi(A, T) = 0,$$

where A , T , and u are connected by the relations (2.17), (2.20), and (2.36). We shall assume that function Φ has the following form: $\Phi = (\Phi_1, \dots, \Phi_n)$,

$$(3.2) \quad \Phi_i(A, T) = k_i(T)A_1^{\alpha_{i1}} \dots A_m^{\alpha_{im}} \quad (i = 1, \dots, n),$$

where $k_i'(T) \geq 0$, and a cut-off of the form (1.34) of Chapter 8 is made where a cut-off at different temperatures is allowed.

Let

$$(3.3) \quad \Psi_i(u) = - \sum_{j=1}^n K_{ij} \Phi_j(A, T) \quad (i = 1, \dots, r),$$

where K_{ij} are the elements of matrix K . We have

$$(3.4) \quad \frac{\partial \Psi_i}{\partial u_j} = L_{ij} - \sum_{l=1}^n K_{il} \frac{\partial \Phi_l}{\partial T} \frac{\partial T}{\partial u_j},$$

where

$$(3.5) \quad L_{ij} = - \sum_{i=1}^n K_{il} \sum_{l=1}^m \frac{\partial \Phi_l}{\partial A_k} \frac{\partial A_k}{\partial u_j}.$$

It follows from (3.2), the positiveness of vector p and A_k ($k = 1, \dots, m$), and the nonnegativeness of K_{ij} that the expression under the summation sign in (3.4) is nonpositive.

Consider (3.5). By virtue of (2.20), we can write

$$(3.6) \quad A = Su + (0, \tilde{A}^+), \quad S = \Gamma_1 \Gamma_0^{-1} B^{-1},$$

where Γ_1 is the matrix formed from the first r columns of matrix Γ ; Γ_0 is the matrix appearing at the intersection of the first r rows and columns of matrix Γ . Invertibility of matrix Γ_0 follows from Proposition 2.2. From (3.5) and (3.6) we obtain

$$(3.7) \quad L_{ij} = - \sum_{l=1}^n \sum_{k=1}^m K_{il} S_{kj} \alpha_{lk} \frac{\Phi_l}{A_k},$$

where S_{kj} are the elements of matrix S .

Thus we have obtained conditions for monotonicity of system (3.1) (cf. §2 of Chapter 8):

If the inequalities

$$(3.8) \quad K_{il} S_{kj} \alpha_{lk} \geq 0$$

are satisfied for all $i, j = 1, \dots, r$, $i \neq j$, $l = 1, \dots, n$, $k = 1, \dots, m$, then $\partial \Phi_i / \partial u_j \geq 0$ ($i \neq j$).

Thus, when conditions (3.8) are satisfied, system (3.1) is monotone.

3.2. Stability. Let us linearize system (3.1) on the traveling wave $u(x)$. We obtain

$$(3.9) \quad dv'' + cv' + b(x)v = 0, \quad v(\pm\infty) = 0,$$

where b is a matrix with elements $\partial\Psi_i/\partial u_j$. When conditions (3.8) are satisfied, matrix $b(x)$ has nonnegative off-diagonal elements. By virtue of (3.4), they are not identically equal to zero since in each row of matrix K there are nonzero elements and $k'_i(T)$ is not identically zero.

Consider the matrix $b_+ = \lim b(x)$ as $x \rightarrow \infty$. Similarly to what was done in Proposition 2.2, we prove that this matrix has all its eigenvalues in the left half-plane if for each $k = 1, \dots, r$ an i between 1 and n may be found such that $\partial\Phi_i/\partial A_k > 0$. This means that for each $k = 1, \dots, r$ a reaction may be found in which substance A_k , with stoichiometric coefficient 1, is consumed and the other substances A_l ($l \neq k, l = 1, \dots, r$) are not consumed.

Let L be the operator defined by the left side of equation (3.9). Using Theorem 5.1 of Chapter 4, we can show that operator L has no eigenvalues in the half-plane $\text{Re } \lambda \geq 0$, with the exception of $\lambda = 0$, which is a simple eigenvalue. Indeed, let us make the substitution $v = \exp(\mu x)y$, where $\mu > 0$ is a sufficiently small number. We obtain operator $L_1 = \exp(-\mu x)L \exp(\mu x)$. Taking into account that $b(x) \equiv 0$ for $x < x_0$, where x_0 is some number, and that $c < 0$, we readily see that operator L_1 satisfies all the conditions of Theorem 5.1 of Chapter 4. It follows from this that operator L satisfies items 1) and 2) of the theorem, and, in place of item 3), we may prove the existence of a bounded positive solution of the adjoint homogeneous equation. From this and from the integrability of a solution v of equation (3.9) we conclude that 0 is a simple eigenvalue of operator L .

Taking into account the relationship of the stability of a wave to the location of the eigenvalues of operator L (see Chapter 5), we arrive at the following theorem.

THEOREM 3.1. *In system (1.2) let us assume that $\varkappa = d$, that the thermal effects q_i of the reactions are positive, and that the following conditions are satisfied:*

- 1) *inequalities (3.8) are valid;*
- 2) *the eigenvalue λ of matrix b_+ which has maximal real part is negative;*
- 3) *a solution $\bar{A}(x), \bar{T}(x)$ of system (1.2) with boundary conditions (1.4) exists such that $u(x) = B\bar{A}(x)$ is monotone. Here $\bar{A} = (\bar{A}_1, \dots, \bar{A}_r)$.*

Then this solution is stable in the following sense. For an arbitrary solution of the system of equations

$$(3.10) \quad \frac{\partial T}{\partial t} = \varkappa \frac{\partial^2 T}{\partial x^2} + c \frac{\partial T}{\partial x} + (q, \Phi),$$

$$(3.11) \quad \frac{\partial A}{\partial t} = d \frac{\partial^2 A}{\partial x^2} + c \frac{\partial A}{\partial x} + \Gamma\Phi,$$

with initial conditions

$$T(x, 0) = T^0(x), \quad A(x, 0) = A^0(x),$$

satisfying the equations

$$(3.12) \quad T^0(x) - T^+ = (p, A^0(x) - A^+),$$

$$(3.13) \quad (s^k, A^0(x) - A^+) = 0 \quad (k = 1, \dots, m - r),$$

where p and s^k are given by relations (1.9) and (1.8), the inequality

$$\|\widehat{A}^0(x) - \widehat{A}(x)\|_a \leq \varepsilon$$

and the condition

$$(3.14) \quad \lim_{|x| \rightarrow \infty} (\widehat{A}^0(x) - \widehat{A}(x))(1 + e^{-ax}) = 0$$

imply that

$$\begin{aligned} \|T(x, t) - \overline{T}(x + h)\|_a &\leq Me^{-bt}, \\ \|A(x, t) - \overline{A}(x + h)\|_a &\leq Me^{-bt}. \end{aligned}$$

Here $\|\cdot\|_a$ is a weighted norm, defined for an arbitrary function $g(x)$ (or vector-valued function) by the equation

$$\|g\|_a = \sup_x |g(x)(1 + e^{-ax})|,$$

a is an arbitrary number: $0 < a < |c|/d$; ε, M, b are positive numbers independent of the initial condition; h is a constant depending on the initial condition.

Validity of the theorem is a consequence of Theorem 4.1 of Chapter 5.

REMARKS. 1) In a condition of the theorem it is assumed that solutions exist with a monotone function $u(x)$. Existence of such solutions was proved in the preceding section. In the theorem concerning stability it is the fact of the existence of solutions that is important and not the conditions under which it was obtained.

2) Condition (3.8) is the condition for monotonicity of system (3.1) and is basic to the theorem concerning stability of a wave. It is connected with the choice of matrix B , and some arbitrariness in the choice of this matrix makes it possible to broaden the class of reactions for which stability of traveling waves can be proved. Depending on how matrix B is chosen, satisfaction of inequalities (3.8) can be verified directly. In the following section we show, for linearly independent reactions, how to choose matrix B and we write the conditions (3.8) explicitly in terms of stoichiometric coefficients.

3) Matrix b_+ has the form $\widehat{B}\Gamma PB^{-1}$ (see (2.10)). It has nonnegative off-diagonal elements (by virtue of condition (3.8)) and a nonpositive eigenvalue with maximal real part to which there corresponds a nonnegative eigenvector. In the statement of the theorem, "something more" is needed. Negativeness of the leading eigenvalue of matrix b_+ is a consequence of Proposition 2.2.

4) In the theorem it is required that an initial perturbation tend towards zero at the infinities (see (3.14)). For the solution this property is also satisfied for all $t > 0$.

5) The theorem presented here concerns stability in the space C . Similarly, stability of a wave can be obtained in the space W_2^1 (see Theorem 2.2 in Chapter 5).

3.3. Linearly independent reactions. We recall (see §2 of Chapter 8) that in the case of linearly independent reactions ($n = r$) the conditions for monotonicity become substantially simpler. As matrix B we can take the matrix $B = -\Gamma_0^1$. In this case $\widehat{\Gamma} = \Gamma_0$, $K = E$, the unit matrix, and $S = -\Gamma$. Inequality (3.8) assumes the form: $\gamma_{jk} \geq 0$, if $\alpha_{ik} > 0$ ($i \neq j, i, j = 1, \dots, r; k = 1, \dots, m$). This means that if the k th substance is consumed in the i th reaction, then in any other reaction it must be produced with a stoichiometric coefficient at least equal to its stoichiometric

coefficient in the i th reaction. For example, if the k th substance is consumed in two reactions, the i th and the j th, the inequalities $\gamma_{ik} \geq 0$ and $\gamma_{jk} \geq 0$ must then be satisfied.

It is obvious that the conditions mentioned will be satisfied, in particular, if each substance is consumed in no more than one reaction.

§4. Examples

In this section the results presented above on the existence and stability of waves are illustrated through typical examples. We note that the monotonicity conditions discussed in Chapter 8 and in the preceding sections of this chapter exhibit an unconditional character. For example, for linearly independent reactions in which each substance is consumed in at most one reaction, the system may be reduced to a monotone system independently of the values of the parameters. But if there are competing stages in the reaction scheme, the system can also be reduced to a monotone system, but upon satisfaction of certain conditions. This question has not been discussed for a reaction scheme of a general type; it will be considered in the examples to be presented.

4.1. Single-stage reactions. This case has been studied in the literature in detail (see, for example, [Zel 5]); it is presented here for completeness.

A solution of traveling-wave type for the single-stage chemical reaction

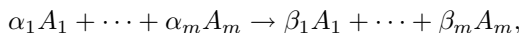

accompanied by the liberation of heat, satisfies the system of equations

$$(4.1) \quad \varkappa T'' + cT' + qF(A_1, \dots, A_m, T) = 0,$$

$$(4.2) \quad d_j A_j'' + cA_j' + \gamma_j F(A_1, \dots, A_m, T) = 0, \quad j = 1, \dots, m,$$

where F is the reaction rate, usually considered in the form

$$F(A_1, \dots, A_m, T) = k(T)A_1^{\alpha_1} \times \cdots \times A_m^{\alpha_m}$$

(law of mass action), $\gamma_j = \beta_j - \alpha_j$. If the coefficients of diffusion are all equal ($d_j = d$, $j = 1, \dots, m$), then, as is readily seen,

$$A_j = \frac{\gamma_j}{\gamma_1} A_1 + \alpha_j, \quad j = 1, \dots, m,$$

where the a_j are constants (it is assumed that $\gamma_1 \neq 0$). If, in addition, the coefficient of thermal conductivity \varkappa is equal to the coefficient of diffusion d (similarity of concentration and temperature fields), then

$$T = \frac{q}{\gamma_1} A_1 + T^+,$$

where T^+ is a constant. In this case the system of equations (4.1), (4.2) may be reduced to a scalar equation for which questions of existence and stability of waves are answered fairly easily (see Chapter 1). The type of source, characteristic in combustion, is shown in Figure 1.3 of the Introduction. For this source a wave exists, is unique, and is stable.

The situation is substantially more involved if $\varkappa \neq d$. Existence of waves and their uniqueness was established in [Kan 4] for $d < \varkappa$. It was shown in [Bac 1] that for $d > \varkappa$, and for specially selected conditions, a wave can be nonunique (see

also [**Bon 2**]). From the general theorem presented in §2 the existence of waves follows directly; however, the theorem does not permit any judgement concerning the number of such waves. We note also that the Leray-Schauder method can be used to establish the existence of waves even when the coefficients of diffusion are not all equal to one another.

A large number of papers (see the supplement to this Part) has been devoted to the stability of waves of combustion in the case of a single-stage reaction with $\varkappa \neq d$. This problem will not be considered here.

As a rule, chemical reactions are many-stage reactions, i.e., they consist not of a single reaction, as in the preceding example, but of a large number of reactions. We consider such reactions in the following examples.

4.2. Independent reactions. By independent reactions we mean reactions in which the substances being consumed are used up in only one reaction and are not produced in any reaction. For the general reaction scheme (1.1) this means that if $\alpha_{i_0 j_0} \neq 0$, then

$$\alpha_{i j_0} = 0, \quad i \neq i_0, \quad \beta_{i j_0} = 0, \quad i = 1, \dots, n.$$

For simplicity, we limit the discussion here to an example of three bimolecular reactions:

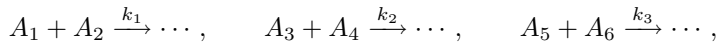

since all that follows carries over, in an obvious way, to an arbitrary number of independent reactions, an arbitrary number of substances taking part in each reaction, and to arbitrary stoichiometric coefficients.

We note that the reaction rate does not depend on the substances being formed (since these substances do not include A_1, \dots, A_6). Therefore, it is not necessary to consider the right sides of the reactions.

The complete system of equations of heat conduction and diffusion has, on the assumption of equality of the diffusion coefficients, the form

$$\begin{aligned} \varkappa T'' + cT' + q_1 k_1(T) A_1 A_2 + q_2 k_2(T) A_3 A_4 + q_3 k_3(T) A_5 A_6 &= 0, \\ dA_1'' + cA_1' - k_1(T) A_1 A_2 &= 0, \\ dA_2'' + cA_2' - k_1(T) A_1 A_2 &= 0, \\ \dots & \\ dA_6'' + cA_6' - k_1(T) A_5 A_6 &= 0. \end{aligned}$$

Going over to the vector matrix form of notation (see (1.2)), we can write the equation for the concentrations in the form

$$dA'' + cA' + \Gamma F = 0,$$

where $F = (F_1, F_2, F_3)$, $A = (A_1, \dots, A_6)$,

$$F_1 = k_1(T) A_1 A_2, \quad F_2 = k_2(T) A_3 A_4, \quad F_3 = k_3(T) A_5 A_6,$$

$$\Gamma = \begin{pmatrix} -1 & 0 & 0 \\ -1 & 0 & 0 \\ 0 & -1 & 0 \\ 0 & -1 & 0 \\ 0 & 0 & -1 \\ 0 & 0 & -1 \end{pmatrix}.$$

It is easy to see that the graph of the reaction is open since $\lambda\Gamma < 0$ for vector λ , made up, for example, of ones (which corresponds to the sum of the rows of the matrix). The reactions are linearly independent, i.e., the columns of matrix Γ are linearly independent, and there are balances, i.e., the rows of matrix Γ are linearly dependent. The balances have the form

$$A_2 = A_1 + a_1, \quad A_4 = A_3 + a_2, \quad A_6 = A_5 + a_3,$$

where a_1, a_2, a_3 are constants, which, without loss of generality, we can assume to be positive. In this case the balance polyhedron Π is specified by the inequalities $A_1 \geq 0, A_3 \geq 0, A_5 \geq 0$. It contains the asymptotically stable stationary point $A_1 = A_3 = A_5 = 0$ and no other stationary points of the kinetic system.

Thus, if the thermal effects $q_i, i = 1, 2, 3$, of the reactions are positive, all the conditions of the theorem for the existence of waves are satisfied (for an appropriate specification of the conditions at the infinities and a "cut-off" of the source).

For independent reactions the conditions for reduction of the system to a monotone system in the case $\varkappa = d$ are also satisfied (each substance is consumed in at most one reaction; see §3.3). Using the change of variables described in §3.3, which in the given case has the form

$$A_1 = u_1, \quad A_3 = u_2, \quad A_5 = u_3,$$

we obtain the system of equations

$$du_i'' + cu_i' - k_i(T)u_i(u_i + a_i) = 0,$$

where $T = T^+ - q_1u_1 - q_2u_2 - q_3u_3$. This system is, obviously, monotone if $k_i'(T) \geq 0$ ($\neq 0$) and the wave in this case is stable, both with respect to small perturbations and globally (in the case of monotone initial conditions), is unique, and the minimax representation of the speed applies.

4.3. Sequential reactions. We consider examples of reactions in which each substance is consumed in at most one reaction, and in each reaction, except for the first, the substance consumed is that formed in the preceding reaction.

As we did before, we limit the discussion to simple examples, which can be easily generalized.

We consider sequential reactions of the form

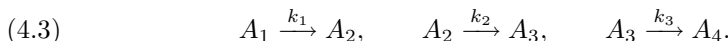

Reactions (4.3) are linearly independent and, consequently, the graph of reaction is open. The corresponding system of equations has the form

$$\begin{aligned} \varkappa T'' + cT' + \sum_{i=1}^3 q_i F_i &= 0, \\ dA'' + cA' + \Gamma F &= 0, \end{aligned}$$

where

$$\begin{aligned} A &= (A_1, A_2, A_3), & F &= (F_1, F_2, F_3), & F_i &= k_i(T)A_i, \\ \Gamma &= \begin{pmatrix} -1 & 0 & 0 \\ 1 & -1 & 0 \\ 0 & 1 & -1 \end{pmatrix}. \end{aligned}$$

It is easy to see that $\lambda\Gamma < 0$ for $\lambda = (3, 2, 1)$.

We apply the following change of variables to obtain a monotone system:

$$A_1 = u_1, \quad A_2 = -u_1 + u_2, \quad A_3 = -u_2 + u_3.$$

We have

$$(4.4) \quad du'' + cu' + \Phi(u) = 0,$$

where $u = (u_1, u_2, u_3)$, $\Phi = (\Phi_1, \Phi_2, \Phi_3)$,

$$(4.5) \quad \begin{aligned} \Phi_1(u) &= -k_1(T)u_1, & \Phi_2(u) &= -k_2(T)(u_2 - u_1), \\ \Phi_3(u) &= -k_3(T)(u_3 - u_2), & T &= T^+ - q_1u_1 - q_2u_2 - q_3u_3. \end{aligned}$$

In the balance polyhedron we have the asymptotically stable stationary point $u_1 = u_2 = u_3 = 0$, and there are no other stationary points (not connected with a cut-off in the source).

Thus, when $q_i > 0$ conditions for the existence theorem are satisfied; but if, in addition, $\varkappa = d$, the system is then monotone and the results, obtained for such systems, are valid.

We also present an example of bimolecular sequential reactions:

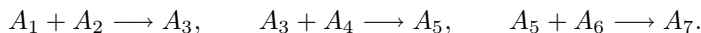

A change of variables, leading to a monotone system, with balances taken into account has the form

$$\begin{aligned} u_1 &= A_2, & u_2 &= A_4, & u_3 &= A_6, \\ A_1 &= u_1 + a_1, & A_3 &= u_2 - u_1 + a_2, & A_5 &= u_3 - u_2 + a_3. \end{aligned}$$

As a result we obtain system (4.4) in which

$$\begin{aligned} \Phi_1 &= -k_1(T)u_1(u_1 + a_1), & \Phi_2 &= -k_2(T)u_2(u_2 - u_1 + a_2), \\ \Phi_3 &= -k_3(T)u_3(u_3 - u_2 + a_3); \end{aligned}$$

here T is given by the expression (4.5).

4.4. Some other examples. In the following examples each substance is consumed in at most one reaction and therefore the corresponding systems can be reduced to monotone systems. One example is given by

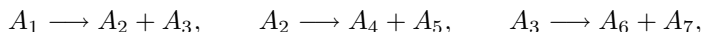

and another by

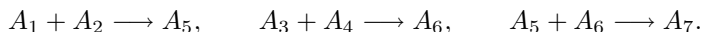

The following reaction is frequently considered in the literature as an example of nonbranching chain reactions [**Zel 5**, **Fran 1**]:



Here A and B are active centers; A_2 and B_2 are initial substances.

We leave it to the reader to make the change of variables and to be convinced that monotone systems are obtained as a result.

We note that similarly to the case of independent reactions, which can be treated as a collection of single-stage reactions, we can consider a reaction scheme

consisting of a collection of many-stage reactions. For example, we have the independent sequential reactions

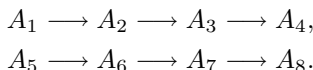

Up to this point we have considered examples of reactions with positive thermal effects and containing no competing stages. Although this class of reactions is fairly broad, reactions for which these conditions are not satisfied are surely of interest. Here we shall obtain not unconditional results concerning, for example, the stability of waves, but specific relations among the parameters under which the system may be reduced to a monotone system which implies stability of a wave.

4.5. Thermal effects with alternating signs. Consider sequential reactions



By means of the change of variables $A_1 = u_1$, $A_2 = u_2 - u_1$ the system of equations (1.2) is reduced to the form

$$du_i'' + cu_i' + \Phi_i(u) = 0, \quad i = 1, 2,$$

where

$$\Phi_1(u) = -k_1(T)u_1, \quad \Phi_2(u) = -k_2(T)(u_2 - u_1), \quad T = T^+ - q_1u_1 - q_2u_2.$$

We have

$$\begin{aligned} \frac{\partial \Phi_1}{\partial u_2} &= k_1'(T)u_1q_2, \\ \frac{\partial \Phi_2}{\partial u_1} &= k_2(T) + k_2'(T)(u_2 - u_1)q_1. \end{aligned}$$

It is obvious that if $q_2 < 0$ the condition for monotonicity cannot then be satisfied. But if $q_2 > 0$, $q_1 < 0$ (and $T^+ > T^-$), then in the case of Arrhenius temperature dependence

$$k_2(T) = k_2^0 e^{-E_2/RT}$$

(neglecting a narrow strip close to the temperature of the source cut-off in which a transition takes place from the Arrhenius exponent to the identically zero one; this assumption, of necessity, is used in what follows), this condition takes the form

$$(4.7) \quad \frac{RT^2}{(-q_1)E_2} > u_2 - u_1.$$

Inequality (4.7), which a solution must satisfy, can be used to obtain various qualitative and quantitative conditions for the reduction of the system to a monotone system and, consequently, for wave stability. Without going into the details, we note that a stationary solution can be obtained approximately fairly easily by analytical methods: the narrow reaction zone method or a similar method involving matched asymptotic expansions; these methods are well developed for combustion problems (see [Zel 5] and the supplement to Part III). This makes it possible to obtain explicit relationships among the parameters from condition (4.7).

Various model reactions with thermal effects of different signs have been considered by approximate analytical methods in [Borov 1, 2, Nek 1, 2, Vol 36]).

4.6. Reactions with competing stages. In [Kha 4–7] it was shown that in the case of the parallel reactions



a wave can be nonunique. This means that the corresponding system cannot be reduced to a monotone system. This example shows that the sufficient condition for reducibility, formulated in §3, applicable for linearly independent reactions in the absence of competing stages (something less is required, in fact) is an essential one. Nevertheless, it is possible in some cases to reduce system (1.2) to a monotone system and, by the same token, to establish the stability of waves even in the presence of competing stages. Existence of waves can be established even in those cases in which the general theorem concerning the existence of waves cannot be applied directly. In particular, this is the case for the reactions (4.8) for which there is no asymptotic stable stationary point in the balance polyhedron, but, in its stead, there appears a stable stationary face.

In what follows we consider examples illustrating various types of reactions with competing stages.

4.6.1. *An abundant component consumed in several reactions.* It is convenient to track general patterns, typical for this case, through the example of sequential-parallel reactions



The kinetic system has the form

$$\begin{aligned} \frac{dA_1}{dt} &= -k_1 A_1 A_2 - k_2 A_1 A_3, \\ \frac{dA_2}{dt} &= -k_1 A_1 A_2, \\ \frac{dA_3}{dt} &= k_1 A_1 A_2 - k_2 A_1 A_3, \\ \frac{dT}{dt} &= q_1 k_1 A_1 A_2 + q_2 k_2 A_1 A_3. \end{aligned}$$

Let us make the change of variables $u_1 = A_2$, $u_2 = A_2 + A_3$. Then $A_1 = u_1 + u_2 + a$, $T = T^+ - q_1 u_1 - q_2 u_2$,

$$(4.9) \quad \begin{aligned} \frac{du_1}{dt} &= -k_1(T)u_1(u_1 + u_2 + a) \equiv \Phi_1(u), \\ \frac{du_2}{dt} &= -k_2(T)(u_2 - u_1)(u_1 + u_2 + a) \equiv \Phi_2(u). \end{aligned}$$

The balance polyhedron is defined by the inequalities

$$u_1 \geq 0, \quad u_2 \geq u_1, \quad u_1 + u_2 + a \geq 0.$$

Thus, if $a > 0$, then in the balance polyhedron there exists an asymptotically stable stationary point $u_1 = u_2 = 0$ of the kinetic system, and there are no other stationary points. This means that for the case in which a substance, being consumed in more than one reaction, is found to be in excess, the presence of parallel reactions does not lead to the appearance of nonisolated stationary points in the balance polyhedron. We can employ the theorem for the existence of waves in this case directly. If $a < 0$, i.e., the substance is found to be in deficiency, then there is

no asymptotically stable stationary point in the balance polyhedron; however, a stable stationary face appears, situated on the line $u_1 + u_2 + a = 0$. In this case the theorem cannot be used directly, but it is possible to obtain the existence of waves. This will be shown for an example in 4.6.4.

We find conditions under which system (4.9) is monotone, i.e., matrix Φ'_u has nonnegative off-diagonal elements. We have

$$\begin{aligned}\frac{d\Phi_1}{u_2} &= -k_1(T)u_1 + q_2k'_1(T)u_1(u_1 + u_2 + a), \\ \frac{d\Phi_2}{u_1} &= k_2(T)(u_1 + u_2 + a) - k_2(T)(u_2 - u_1) + q_1k'_2(T)(u_2 - u_1)(u_1 + u_2 + a).\end{aligned}$$

We shall assume that $q_1 > 0$, $q_2 > 0$, $a > 0$, $k'_i(T) \geq 0$, $i = 1, 2$. In this case, $\partial\Phi_2/\partial u_1 \geq 0$ in the balance polyhedron, since, obviously, the inequality

$$u_1 + u_2 + a \geq u_2 - u_1$$

holds. The inequality $\partial\Phi_1/\partial u_2 \geq 0$ will be satisfied if

$$aq_2k'_1(T) \geq k_1(T).$$

In the case of the Arrhenius temperature dependence $k_1(T) = k_1^0 \exp(-E_1/RT)$, this condition takes the form

$$\frac{RT^2}{q_2E_1} \leq a$$

and, since the temperature in the wave is monotone, it is then sufficient to require fulfillment of the inequality $\delta_{21} \leq a$, where $\delta_{21} = R(T^+)^2/q_2E_1$.

4.6.2. *A substance, being consumed in several reactions, is formed in each of them.* Here we need to require that the amount of the substance produced be at least equal to that expended. The conditions of §3.3 will then be satisfied; by virtue of these conditions the system can be reduced to a monotone system. We consider, as an example, the branching chain reaction with branching chain stage

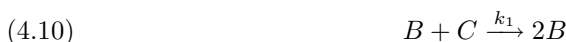

and a continuation of the chain



Making the change of variables $u_1 = C$, $u_2 = D$, we obtain the system of equations

$$du''_i + cu'_i + \Phi_i(u) = 0, \quad i = 1, 2,$$

where

$$\begin{aligned}\Phi_1(u) &= -k_1(T)u_1(a - u_1), & \Phi_2(u) &= -k_2(T)u_2(a - u_1), \\ T &= T^+ - q_1u_1 - q_2u_2.\end{aligned}$$

The balance polyhedron is defined by the inequalities

$$u_1 \geq 0, \quad u_2 \geq 0, \quad u_1 \leq a$$

and in it we have the asymptotically stable stationary point $u_1 = u_2 = a$ and the unstable stationary face $u_1 = a$.

In Chapter 8 this example was considered in the isothermal case and a proof was given for the existence and stability of waves joining stable and unstable stationary

faces. For nonisothermal waves, when a cut-off is made in the source, a wave also exists and is stable, but, for fixed values at the infinities (for $T^- < T^*$), it is unique, i.e., it exists for one value of the speed and not for a half-axis of speeds.

We note, in the case of thermal waves, that the reactions (4.10), (4.11) can be supplemented by the reaction initiating the chain $A \rightarrow B$.

4.6.3. *Linearly dependent reactions.* In the preceding two examples we considered linearly independent reactions. We consider yet another example of sequentially-parallel reactions

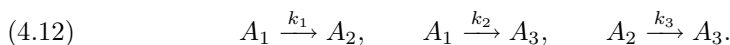

The kinetic system has the form

$$\begin{aligned} \frac{dA_1}{dt} &= -k_1A_1 - k_2A_1, \\ \frac{dA_2}{dt} &= k_1A_1 - k_3A_2, \\ \frac{dT}{dt} &= q_1k_1A_1 + q_2k_2A_1 + q_3k_3A_2. \end{aligned}$$

The columns of matrix

$$\Gamma = \begin{pmatrix} -1 & -1 & 0 \\ 1 & 0 & -1 \end{pmatrix}$$

are linearly dependent, which corresponds to linear dependence of the reactions: the second reaction is the sum of the first and the third. A corresponding relationship also holds for thermal effects of the reactions: $q_2 = q_1 + q_3$. We assume that all three reactions are exothermic, i.e., $q_2 > q_1 > 0$.

Let us make the change of variables $u_1 = A_1$, $u_2 = A_1 + A_2$. Then

$$(4.13) \quad \begin{aligned} \frac{du_1}{dt} &= -(k_1 + k_2)u_1 \equiv \Phi_1(u), \\ \frac{du_2}{dt} &= -k_2u_1 - k_3(u_2 - u_1) \equiv \Phi_2(u), \end{aligned}$$

where $T = T^+ - q_1u_1 - q_3u_2$, since

$$\frac{dT}{dt} = -q_1 \frac{dA_1}{dt} - q_3 \left(\frac{dA_1}{dt} + \frac{dA_2}{dt} \right).$$

It is easy to see that $\partial\Phi_1/\partial u_2 \geq 0$. Further, we have

$$\frac{\partial\Phi_2}{\partial u_1} = -k_2 + k_3 + q_1k_2'u_1 + q_1k_3'(u_2 - u_1).$$

In the balance polyhedron $u_1 \geq 0$, $u_2 \geq u_1$ the inequality $\partial\Phi_2/\partial u_1 \geq 0$ will be satisfied if $k_3(T) \geq k_2(T)$ (as elsewhere, we assume that $k_i' \geq 0$). This means that a wave will be unique and stable (for $\varkappa = d$) if the sequential stage prevails over the parallel stage.

We note that the graph of reaction (4.12) is open, and that in the balance polyhedron there is the asymptotically stable stationary point $A_1 = A_2 = 0$ and no other stationary points. Therefore the theorem concerning existence of waves can be applied directly. But if we reduce the rate of the third reaction, then, in the limit for $k_3 = 0$, we obtain reaction (4.8). In order to make an inference concerning the existence of waves for this reaction, we need to observe that in the passage

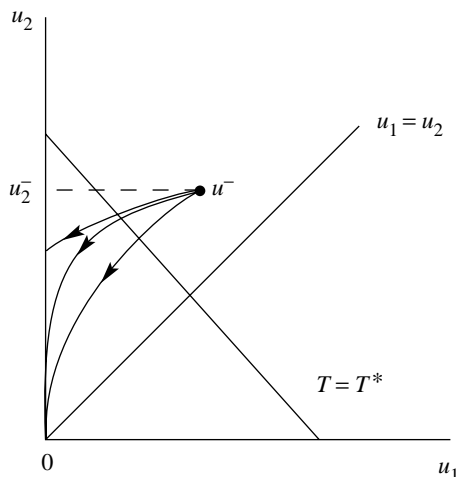

FIGURE 4.1. Solution of system (4.13) for different k_3

to the limit the wave cannot disappear. This problem is considered briefly in the following section.

4.6.4. *Parallel reactions.* In Figure 4.1 the qualitative behavior of a wave is shown for system (4.13) for a reduction in k_3 . When $k_3 \equiv 0$ the stationary points fill out the entire face $u_1 = 0$ of the balance polyhedron. This is typical for reactions with competing stages when there is no excess of the substance being consumed in them. In particular, due to the nonisolatedness of the stationary points the theorem concerning the existence of waves cannot be applied directly.

When $k_3 \equiv 0$ the value of $u^+ = \lim_{x \rightarrow \infty} u(x)$, generally speaking, is no longer equal to 0 and is found on the interval $[0, u_2^-]$ of the axis of ordinates.

As we have already noted, in letting $k_3 \rightarrow 0$ we need to see that the wave does not disappear. If $u_2^- < (T^+ - T^*)/q_3$, i.e., the point $(0, u_2^-)$ is found in the half-plane $T > T^*$ (we shall assume, for simplicity, that this condition is satisfied), then it is sufficient to show that a monotone solution cannot be attracted to intermediate stationary points arising due to a cut-off in the source. This may be done precisely as in the proof of the theorem concerning existence of waves.

We proceed now to the problem concerning the number of waves. It was noted, in the preceding example, that for function k_3 sufficiently large ($k_3(T) \geq k_2(T)$) the wave is unique. For $k_3 \equiv 0$, a wave, as shown in [Kha 4–7], can be nonunique. Apparently, nonuniqueness arises for small k_3 . However, from the general theorem concerning the existence of waves we can only conclude that the sum of the indices over all monotone (we mean the monotonicity of functions $u(x)$) waves is equal to 1. This means that if we consider solutions with nonzero indices (i.e., those which do not vanish with a small change in the parameters), there must then be an odd number of them, but how many is, in fact, not known. Therefore, to determine the number of waves other approaches also need to be employed. One of the possible approaches is associated with identifying the positive invariant sets. We recall that this approach was employed in Chapter 8 (see §5.1) in studying waves in the monostable case.

The basic idea in using positive invariant sets to study the number of waves

consists in the following. First, we need to determine the conditions for which there is more than one positive invariant set in the balance polyhedron; in particular, conditions such that a wave cannot belong simultaneously to two sets. And, second, we need to show that a wave exists in each invariant set. This approach can be realized for the reactions (4.8) and for more involved examples.

Bibliographic commentaries¹

Earlier in this chapter the proof for the existence of waves in combustion problems was carried out by the Leray-Schauder method (see [Vol 6, 22–25]). There are many papers in which the existence of combustion waves is proved by other methods. We turn our attention briefly to some of these papers, changing the notation whenever necessary.

One of the first papers in which a proof for the existence of combustion waves was given is a paper by Ya. I. Kanel' [Kan 4]. In it he considered the system of equations

$$(C.1) \quad \begin{aligned} u'' - cu' + f(u)v &= 0, \\ \lambda v'' - cv' - f(u)v &= 0, \end{aligned}$$

with boundary conditions

$$(C.2) \quad u(\pm\infty) = u_{\pm}, \quad v(-\infty) = v_- > 0, \quad v(+\infty) = 0.$$

Here u and v are, respectively, dimensionless temperature and concentration of the initial substance; c is the wavespeed; λ is the ratio of the coefficient of diffusion to the coefficient of heat conduction; $f(u) = 0$ for $u < \alpha$, $f(u) > 0$ for $u > \alpha$, $u_- < \alpha < u_+$.

Setting $p = u'$ and considering u as an independent variable, from (C.1) we obtain

$$(C.3) \quad \begin{aligned} \frac{dp}{du} &= c - f(u)\frac{v}{p}, \\ \frac{dv}{du} &= \frac{c}{\lambda p}(u + v - u_+) - \frac{1}{\lambda}. \end{aligned}$$

Instead of boundary conditions (C.2), the conditions specified are

$$(C.4) \quad v(u_-) = v_-, \quad v(u_+) = 0, \quad p(u_{\pm}) = 0.$$

The solution $p(u)$ of system (C.3) may be estimated from above and from below by the solutions $p_1(u)$ and $p_2(u)$ of the equations

$$\frac{dp}{du} = c - f(u)\frac{u_+ - u}{p}$$

and

$$\frac{dp}{du} = c - f(u)\frac{u_+ - u}{\lambda p}$$

and, with the aid of these estimates, existence of solutions of problem (C.3), (C.4) is established. Moreover, if $0 < \lambda < 1$, uniqueness of the solution is also proved. In [Beres 4] a proof is also given for the existence of solutions for system (C.1) and

¹See also the supplement to Part III.

asymptotic solutions are obtained for the case in which the activation energy tends towards infinity.

A problem of interest is that concerning the number of waves for $\lambda > 1$. This problem was considered in [Bac 1] for the case in which the coefficients of diffusion and heat conduction depend on the temperature. In this case the system of equations has the form

$$\begin{aligned}(\alpha_1(u)u')' - cu' + f(u)v &= 0, \\(\alpha_2(u)v')' - cv' + f(u)v &= 0,\end{aligned}$$

where $\alpha_2(u)/\alpha_1(u) \equiv \lambda$. By methods similar to those used in [Kan 4] it was shown that for arbitrary $\lambda > 1$ the function $\varphi(u) = \alpha_1(u)f(u)$ can be selected so that at least two waves exist. Nonuniqueness of combustion waves is shown also in [Bon 2].

As has already been noted, nonuniqueness can have a kinetic nature. This was first proved in [Kha 4–7] for the case of parallel reactions by a method of matching of asymptotic expansions (see also §4 and the supplement to Part III).

There are many papers in which existence of waves is proved on the basis of an analysis of the behavior of trajectories in the phase space of an autonomous system of first order equations: in [Vag 1] for the propagation of a combustion wave in a condensed medium; in [Shk 2] in the presence of heat loss for a reaction of zero order; in [Vol 33] for polymerization and crystallization that, in essence, are close to sequential reactions; in [Kis 1] for the case of more complex kinetics.

In [Beres 1, Bon 1, Hei 1] the Leray-Schauder method is applied in proving the existence of combustion waves with a complex kinetics. This method is applied in proving the existence of solutions on a finite interval, following which a passage to the limit is made over the length of the interval.

Problems relating to the stabilization of solutions of equations from combustion theory were studied in [Kan 5]. Finally, we note also the papers [Beres 2–4, Braun 1, 3, Gio 1, Has 5, Nor 1, 2] in which various problems of combustion are considered.

Estimates and Asymptotics of the Speed of Combustion Waves

The speed of combustion waves is an important characteristic of these waves. A large number of papers devoted to a study of this characteristic exist, mainly, by approximate analytical and asymptotic methods (see the commentaries to this chapter and the supplement to Part III). Here, as a rule, a question arises about the accuracy of the results obtained and the domain of their applicability. Therefore, in many cases analytical investigations are supplemented by numerical studies. In this chapter the speed of combustion waves is investigated by the minimax method and by the method of successive approximations, a method very little employed for the study of wave solutions of parabolic equations. This situation is apparently associated with the fact that the mathematical theory has not been sufficiently developed; moreover, in using these methods certain technical difficulties can arise, the sense of which will be made clear below.

A minimax representation for the wavespeed was obtained in Chapter 1 for a scalar equation and in Chapter 5 for monotone systems of equations describing a broad class of gas combustion processes (see Chapters 8, 9). In this chapter a minimax representation for the speed will also be obtained for a model of gasless combustion. The minimax method makes it possible to obtain two-sided estimates of the speed, the accuracy of which is determined by the proximity of estimates from above and from below. If the asymptotics of the estimates from above and from below are in agreement, then asymptotics of the speed will have been obtained. In §1 the minimax method is applied to the analysis of several models of gasless combustion; in §2 combustion of gases is considered.

The method of successive approximations (§3) also makes it possible to obtain two-sided estimates and asymptotics of the speed. Its application to combustion problems is illustrated for a model describing propagation of a combustion wave in a condensed medium. We remark that the basic test-function used in the minimax method in some cases serves as an accurate first approximation in the successive approximations method.

§1. Estimates for the speed of a combustion wave in a condensed medium

1.1. Introduction. We consider the system of equations

$$(1.1) \quad \varkappa \frac{d^2 T}{dx^2} - v \frac{dT}{dx} + q\varphi(a)k(T) = 0,$$

$$(1.2) \quad v \frac{da}{dx} + \varphi(a)k(T) = 0,$$

describing propagation of the combustion front in a condensed medium during the

course of a single-stage chemical reaction. Here T and a are the temperature and concentration of a reactant, v is the speed of the front, x is a spatial variable, $-\infty < x < \infty$, $\varphi(a)$ gives the kinetics of the reaction, \varkappa is the coefficient of thermal diffusivity, $q = Q/c$, where Q is the thermal effect of the reaction and c is the heat capacity. The reaction rate has an Arrhenius temperature dependence

$$k(T) = k_0 \exp(-E/RT) \quad (T_c < T),$$

$$k(T) = 0 \quad (T_i < T < T_c),$$

where T_c is the cut-off temperature, k_0 is a pre-exponential factor, E is the activation energy, and R is the gas constant. Boundary conditions in domains of the cold reactant ($x \rightarrow -\infty$) and of the reaction products ($x \rightarrow +\infty$) have the form

$$x \rightarrow -\infty: T = T_i, \quad a = 1; \quad x \rightarrow +\infty: dT/dx = 0,$$

where T_i is the initial temperature of the reactant.

It is well known that equations (1.1)–(1.2) can be reduced to a single equation for the concentration as a function of the temperature

$$(1.3) \quad \frac{da}{dT} = \frac{\varkappa \varphi(a)k(T)}{v^2 T - T_b + qa},$$

$$(1.4) \quad T = T_c: a = 1; \quad T = T_b: a = 0,$$

where T_b is the combustion temperature, $T_b = T_i + q$.

Equation (1.3) can, in turn, be written in the form

$$(1.5) \quad v^2 = B(a(T), T),$$

where

$$(1.6) \quad B(\rho(T), T) = \frac{\varkappa \varphi(\rho)k(T)}{(T - T_b + q\rho)d\rho/dT}.$$

In case $a(T)$ is a solution of problem (1.3)–(1.4) the right-hand side of (1.5), considered as a function of T , is a constant, equal to v^2 . We take an arbitrary function $\rho(T)$ satisfying the same boundary conditions (1.4). Expression (1.6) is then no longer a constant and the essence of the method being described consists in the fact that the minimal and maximal values of the function $B(\rho(T), T)$ yield estimates of v^2 from below and from above, respectively. We remark that function $\rho(T)$ can be chosen in an arbitrary way and an arbitrary test function allows us to obtain the estimates. Nevertheless, the closer the test function is to the exact solution, the better are the estimates obtained, and conversely, the accuracy of the estimates obtained indicates the proximity of the test function to the exact solution. Thus we are in a position to clarify the accuracy of approximate solutions known in the literature.

As a simple example of an application of this approach we obtain estimates of the speed for a first order reaction ($\varphi(a) = a$):

$$(1.7) \quad \sigma < v^2 < \frac{\sigma}{1 - \sigma/(\varkappa k(T_b))},$$

where

$$\sigma = \varkappa \int_{T_c}^{T_b} \frac{k(T) dT}{T - T_i}.$$

In order to analyze these estimates, we note that for large activation energies the integral in (1.7) can be calculated approximately by means of the Frank-Kamenetskii transform [**Fran 1**]

$$\int_{T_c}^{T_b} \frac{k(T) dT}{T - T_i} \approx \frac{RT_b^2 k(T_b)}{E(T_b - T_i)}.$$

Thus, from (1.7) it follows that

$$\varkappa k(T_b) \frac{RT_b^2}{Eq} < v^2 < \varkappa k(T_b) \frac{RT_b^2}{Eq} / \left[1 - \frac{RT_b^2}{Eq} \right].$$

As a rule, the quantity RT_b^2/Eq is of order 0.1, and thus we can find a value for the speed accurate to within several percent.

A second example relates to heterogeneous combustion with wide reaction zones, usually modeled by means of exponential kinetics

$$\varphi(\rho) = \exp[-m(1 - \rho)] \quad (\rho > 0),$$

$$\varphi(\rho) = 0 \quad (\rho \leq 0).$$

In this case,

$$\sigma_1 < v^2 < e\sigma_1 \quad (e \approx 2.71),$$

where

$$\sigma_1 = \varkappa k_0 m \exp \left[1 - 2 \left(\frac{Em}{Rq} \right)^{1/2} + \frac{mT_i}{q} \right].$$

The content of this section is as follows. In §1.2 we give a precise formulation of the minimax approach and a short proof of it. Two-sided estimates of the speed for an n th order reaction are derived in §1.3. In §1.4 some generalizations of the approaches used are considered for the case of a reaction of arbitrary kinetics. Exponential kinetics, in the case of large m , is considered in §1.5.

1.2. Variational approach. We introduce the following dimensionless variables and parameters:

$$\begin{aligned} \theta &= (T - T_b)/q; & \gamma &= RT_b^2/(qE); & \beta &= RT_b/E; \\ h &= (T_c - T_i)/q, & \delta &= \beta/\gamma, & u &= v/[\varkappa\gamma k_0 \exp(-1/\beta)]^{1/2}. \end{aligned}$$

Problem (1.3)–(1.4) then takes the form

$$(1.8) \quad \frac{da}{d\theta} = -\frac{1}{\gamma u^2} \frac{\varphi(a)\Phi(\theta)}{a + \theta},$$

where the initial temperature is $\theta_i = -1$, $\theta_c = -1 + h$; the burning temperature is equal to 0, and the boundary conditions may be written as

$$(1.9) \quad a(\theta_c) = 1, \quad a(0) = 0.$$

Here

$$\Phi(\theta) = \exp[\theta/(\gamma + \beta\theta)] \quad (\theta_c \leq \theta \leq 0),$$

$$\Phi(\theta) = 0 \quad (\theta_i \leq \theta < \theta_c).$$

We denote by Ω_1 the set of smooth, monotonically decreasing functions $\rho(\theta)$, defined on $[\theta_c, 0]$ and satisfying the boundary conditions

$$\rho(\theta_c) = 1, \quad \rho(0) \geq 0.$$

We consider also the set of smooth, monotonically decreasing functions $\rho(\theta)$, defined on $[\theta_c, \theta_*]$ for arbitrary θ_* , $\theta_c < \theta_* \leq 0$, and satisfying the boundary conditions

$$\rho(\theta_c) = 1, \quad \rho(\theta_*) = -\theta_*.$$

We denote this set of functions by Ω_2 .

THEOREM 1.1. *Let Ω_1 and Ω_2 be the sets of functions described above. Then*

$$(1.10) \quad u^2 = \inf_{\rho \in \Omega_1} \max_{\theta_c \leq \theta \leq 0} B(\rho(\theta), \theta) = \sup_{\rho \in \Omega_2} \min_{\theta_c \leq \theta \leq \theta_*} B(\rho(\theta), \theta),$$

where

$$(1.11) \quad B(\rho(\theta), \theta) \equiv -\frac{1}{\gamma} \frac{\varphi(\rho)\Phi(\theta)}{(\rho + \theta)d\rho/d\theta}.$$

From (1.10) we have the following inequalities for arbitrary $\rho_1 \in \Omega_1$, $\rho_2 \in \Omega_2$:

$$(1.12) \quad \min_{\theta_c \leq \theta \leq \theta_*} B(\rho_2(\theta), \theta) \leq u^2 \leq \max_{\theta_c \leq \theta \leq 0} B(\rho_1(\theta), \theta).$$

These inequalities play an important role later on in a derivation of estimates of the speed. Moreover, (1.10) follows from (1.12) since there exists a test function—namely, the exact solution—for which (1.10) is satisfied. Thus it is sufficient to prove (1.12).

PROOF. Suppose that the inequality on the right-hand side of (1.12) does not hold. Then there exists a function $\rho_1 \in \Omega_1$ such that

$$u^2 > B(\rho_1(\theta), \theta)$$

and such that, for arbitrary θ ,

$$\frac{d\rho_1}{d\theta} < -\frac{1}{\gamma u^2} \frac{\varphi(\rho_1)\Phi(\theta)}{\rho_1(\theta) + \theta}.$$

Therefore, if trajectory $\rho(\theta)$ of equation (1.8) intersects the graph of the test function at a point $\tilde{\theta} \in [\theta_c, 0)$, i.e., $a(\tilde{\theta}) = \rho_1(\tilde{\theta})$, then

$$da/d\theta|_{\theta=\tilde{\theta}} > d\rho_1/d\theta|_{\theta=\tilde{\theta}}.$$

Since this inequality is also satisfied for $\theta = \theta_c$, we have $a(\theta) > \rho(\theta)$ for arbitrary $\theta \in (\tilde{\theta}, 0]$. If $\rho_1(0) > 0$, then $a(0) > 0$ and we obtain a contradiction with boundary conditions (1.9). In case $\rho_1(0) = 0$, there exists a whole family of trajectories coming into the point $(0, 0)$, which contradicts the saddle-type nature of this point.

The inequality on the left side of (1.12) is proved similarly. □

REMARK. The statement of the theorem remains valid even in the cases of a reaction of zero order and of exponential kinetics, although here the point $(0, 0)$ is not even a stationary point.

1.3. Estimates of the speed of the front for an n th order reaction. In this section we assume that $\varphi(a) = a^n$. We first consider the case of a reaction of the first order ($n = 1$). As a test function we take

$$(1.13) \quad \rho(\theta) = 1 - J(\theta)/J(0),$$

where

$$(1.14) \quad J(\theta) = \int_{\theta_c}^{\theta} \frac{\Phi(\theta) d\theta}{\gamma(1 + \theta)}.$$

It is easy to see that $\rho(\theta)$ is a smooth, monotonically decreasing function satisfying the boundary conditions (1.9). Thus this function can be used both for obtaining estimates from above and for obtaining estimates from below.

Substituting (1.13), (1.14) into (1.11), we obtain the following expression:

$$(1.15) \quad B(\rho(\theta), \theta) = J(0) \frac{\rho(\theta)(1 + \theta)}{\rho(\theta) + \theta},$$

for which maximal and minimal values must be found. We show that these values are $J(0)$ and $J(0)/[1 - \gamma J(0)]$, respectively, assuming, for simplicity, that

$$(1.16) \quad h > (1 - \delta)/\delta.$$

This condition is not a necessary condition; nevertheless, since it is satisfied for parameter values typical for combustion, we shall require its fulfillment.

LEMMA 1.1. *Suppose that condition (1.16) is satisfied. Then function $\xi(\theta)$, defined by the expression*

$$\xi(\theta) = \gamma J(\theta) \exp \left[-\frac{\theta}{\gamma(1 + \delta\theta)} \right],$$

is a monotonically increasing function of θ .

PROOF. It is easy to see that the equation

$$\xi'(\theta) = 0$$

is equivalent to

$$\xi(\theta) = R(\theta),$$

where

$$R(\theta) = \gamma(1 + \delta\theta)^2 / (1 + \theta).$$

From (1.16) it follows that $R(\theta)$ is a monotonically increasing function for $\theta \in (\theta_c, 0)$, and we show that

$$(1.17) \quad \xi(\theta) < R(\theta)$$

for arbitrary $\theta \in (\theta_c, 0)$. If (1.17) is not satisfied, then there exists a value $\tilde{\theta}$, such that $\xi(\theta) < R(\theta)$ for $\theta \in (\theta_c, \tilde{\theta})$ and $\xi(\tilde{\theta}) = R(\tilde{\theta})$ (i.e., $\xi'(\tilde{\theta}) = 0$), since $\xi(\theta_c) < R(\theta_c)$. Thus we have $\xi'(\tilde{\theta}) = 0$, $R'(\tilde{\theta}) > 0$, and, consequently, in contradiction with (1.17), $\xi(\theta) > R(\theta)$ for θ less than $\tilde{\theta}$ but sufficiently close to it. By virtue of (1.17), $\xi'(\theta) > 0$. \square

LEMMA 1.2. *Suppose (1.16) is satisfied. Then for $\gamma < 1$*

$$\xi(\theta) < 1 \quad (\theta_c \leq \theta \leq 0).$$

PROOF. It follows from the proof of Lemma 1.1 that for arbitrary $\theta \in [\theta_c, 0]$

$$\xi(\theta) \leq R(\theta) \leq R(0) = \gamma < 1. \quad \square$$

LEMMA 1.3. *Assume $\xi(\theta) < 1$ for arbitrary $\theta \in [\theta_c, 0]$. Then*

$$(1.18) \quad \rho(\theta) + \theta > 0 \quad (\theta_c \leq \theta < 0).$$

PROOF. Inequality (1.18) is equivalent to

$$(1.19) \quad q(\theta) \equiv J(\theta)/(1 + \theta) < J(0) \quad (\theta_c \leq \theta < 0).$$

It is easy to see that $q(\theta_c) = 0$, $q(0) = J(0)$. In addition, $q(\theta)$ is a monotonically increasing function since

$$q'(\theta) = \frac{1 - \xi(\theta)}{\gamma(1 + \theta)^2} \exp \frac{\theta}{\gamma(1 + \delta\theta)} > 0,$$

and, consequently, (1.19) is satisfied. \square

We proceed now to the proof of the main result for the case of a first order reaction.

THEOREM 1.2. *Let u be the speed of propagation of the combustion wave in problem (1.8)–(1.9), where $\varphi(a) = a$. We assume that condition (1.16) is satisfied and that $\gamma < 1$. Then*

$$(1.20) \quad J(0) < u^2 < J(0)/[1 - \gamma J(0)].$$

PROOF. We show that for arbitrary $\theta \in [\theta_c, 0]$

$$J(0) = B(\rho(\theta_c), \theta_c) \leq B(\rho(\theta), \theta) \leq B(\rho(0), 0) = J(0)/[1 - \gamma J(0)].$$

It follows from Lemma 1.3 that $B(\rho(\theta), \theta)$ is a smooth function. Then

$$B(\rho(\theta), \theta) = J(0) + J(0) \frac{(-\theta)(1 - \rho)}{\rho + \theta} \geq J(0)$$

and the inequality on the left in (1.20) is established.

In fact, under the assumptions made, $B(\rho(\theta), \theta)$ is a monotonically increasing function; however, we confine the discussion to proving that if $B(\rho(\theta), \theta)$ has a maximum at point θ_m , then

$$B(\rho(\theta_m), \theta_m) \leq B(\rho(0), 0).$$

The equation $B'(\rho(\theta), \theta) = 0$ is equivalent to $\theta_m = -\xi(\theta_m)\rho(\theta_m)$. Consequently,

$$(1.21) \quad B(\rho(\theta_m), \theta_m) = J(0) \frac{\rho(\theta_m)(1 + \theta_m)}{\rho(\theta_m) + \theta_m} = J(0) \frac{1 + \theta_m}{1 - \xi(\theta_m)}.$$

Since $\xi(\theta)$ is a monotonically increasing function, we have

$$0 \leq \xi(\theta) \leq \gamma J(0)$$

and (1.20) then follows from (1.21). This completes the proof of the theorem. \square

We consider the case $0 \leq n \leq 1$ and take the test function in the form

$$(1.22) \quad \rho(\theta) = [1 - J(\theta)/J(0)]^{1/(2-n)}.$$

As above, $\rho(\theta)$ is a monotonically decreasing function satisfying the boundary conditions (1.9). Substituting (1.22) into (1.11), we obtain

$$B(\rho(\theta), \theta) = (2 - n)J(0)(1 + \theta)/[1 + \theta/(1 - J(\theta)/J(0))]^{1/(2-n)}.$$

It is easy to see that the denominator of the right-hand side is a monotonically decreasing function of n for arbitrary fixed θ . Then

$$\begin{aligned} B(\rho(\theta), \theta) &\leq (2 - n)J(0)(1 + \theta)/[1 + \theta/(1 - J(\theta)/J(0))] \\ &\leq (2 - n)J(0)/[1 - \gamma J(0)] \end{aligned}$$

as in the case of a reaction of the first order. Further,

$$B(\rho(\theta), \theta) = (2 - n)J(0)[1 + (-\theta)(1 - \rho)/(\rho + \theta)] \geq (2 - n)J(0).$$

A result of our considerations is the following theorem.

THEOREM 1.3. *Let u be the speed of the wave in problem (1.8)–(1.9). Let us assume that $0 \leq n \leq 1$, $\gamma < 1$, and that (1.16) is satisfied. Then*

$$(2 - n)J(0) < u^2 < (2 - n)J(0)/[1 - \gamma J(0)].$$

We proceed now to estimate the speed of the combustion wave in the case $1 < n \leq 3$.

The test function is taken in the form

$$(1.23) \quad \begin{aligned} \rho^{2-n}(\theta) &= 1 + \frac{n-2}{\sigma} J(\theta) & (n \neq 2), \\ \rho(\theta) &= \exp \left[-\frac{1}{\sigma} J(\theta) \right] & (n = 2). \end{aligned}$$

Parameter σ will be selected later. We note, in the case $n > 1$, that σ is selected differently when obtaining estimates from above and from below.

Substituting (1.23) into (1.11), we obtain

$$(1.24) \quad B(\rho(\theta), \theta) = \sigma \frac{\rho(\theta)(1+\theta)}{\rho(\theta) + \theta}.$$

In deriving estimates from above, the denominator in (1.24) must be positive. This condition can be written as

$$\sigma > F(\theta) \quad (\theta_c \leq \theta < 0),$$

where

$$\begin{aligned} F(\theta) &= \frac{(2-n)J(\theta)}{1 - (-\theta)^{2-n}} & (n \neq 2), \\ F(\theta) &= -J(\theta)/\ln(-\theta) & (n = 2). \end{aligned}$$

The simplest method of obtaining estimates from below consists in the following. Let θ_m be the maximum point of function $F(\theta)$. We set

$$(1.25) \quad \sigma = F(\theta_m).$$

Then

$$\begin{aligned} 1 \geq \rho(\theta) &> -\theta & (\theta_c \leq \theta < \theta_m), \\ \rho(\theta_m) &= -\theta_m, \end{aligned}$$

and we can use the minimax approach to obtain estimates of the speed from below. Taking into account (1.25) and the inequality

$$(1.26) \quad B(\rho(\theta), \theta) = \sigma \frac{\rho(\theta)(1+\theta)}{1 + \theta/\rho(\theta)} \geq \sigma \quad (\theta_c \leq \theta \leq 0)$$

we obtain

$$u^2 \geq \min_{\theta_c \leq \theta \leq \theta_m} B(\rho(\theta), \theta) \geq \sigma \geq F(\theta) \quad (\theta_c \leq \theta \leq 0).$$

Thus, each value of function $F(\theta)$, $\theta_c \leq \theta \leq 0$, can be considered as an estimate from below for u^2 :

$$u^2 \geq (2-n)J(0)/[1 - (-\theta)^{2-n}].$$

When $n \leq 1.5$, we can take $\theta = 0$, which gives $u^2 \geq (2-n)J(0)$. In case $n > 1.5$, it is better to take

$$\theta = -\left(\gamma \frac{2-n}{1-\gamma^{2-n}} \right)^{1/(n-1)}.$$

To obtain estimates of the speed of propagation from above, we must find the maximum value of $B(\rho(\theta), \theta)$. As a rule, this problem becomes involved when seeking an analytic solution. It could be solved numerically, but our principal aim here is to obtain analytical estimates. We proceed by obtaining estimates from

above for the maximum value of function B . The main idea consists in obtaining estimates of $\rho(\theta)$ from below and obtaining, thereby, a new function instead of B , one which we can study analytically.

LEMMA 1.4. *Let condition (1.16) be satisfied. Then for an arbitrary root θ_r of the equation*

$$(1.27) \quad \frac{dB(\rho(\theta), \theta)}{d\theta} = 0$$

we have the inequality

$$(1.28) \quad -\gamma < \theta_r,$$

proving that $\gamma < 1, n \leq 3$.

PROOF. Equation (1.27) can be written in the form

$$\theta + \xi(\theta)(2 - n) \frac{\rho^{2-n}}{1 - \rho^{2-n}}(1 - \rho) = 0.$$

It is easy to see that for $0 \leq n \leq 3, 0 \leq \tau \leq 1$, we have the inequality

$$(1.29) \quad 0 \leq (2 - n) \frac{\tau^{2-n}}{1 - \tau^{2-n}}(1 - \tau) \leq 1.$$

From (1.29) it follows that all solutions of equation (1.27) lie in the interval $(\theta_1, 0)$, where θ_1 is the solution of the equation

$$\theta + \xi(\theta) = 0.$$

Since $\xi(\theta) \leq \gamma$ for θ arbitrary, $\theta_c \leq \theta \leq 0$, then $\theta_1 > -\gamma$ and the lemma is thereby proved. □

REMARK. The same result (1.28) holds for solutions of the equation

$$F'(\theta) = 0,$$

since it can also be written in the form

$$\theta + \xi(\theta)(2 - n) \frac{(-\theta)^{2-n}}{1 - (-\theta)^{2-n}}(1 + \theta) = 0.$$

LEMMA 1.5. *Let condition (1.16) be satisfied, $0 \leq n \leq 3$, and let $\gamma < 1$. Then for $-\gamma \leq \theta \leq 0$*

$$(1.30) \quad J(\theta) \leq J(0)[b\theta + 1],$$

where

$$b = (1 - p)/\gamma, \quad p = J(-\gamma)/J(0).$$

PROOF. It is sufficient to show that $J''(\theta) > 0$. We have

$$J''(\theta) = \frac{1 - \gamma R(\theta)}{\gamma^2(1 + \theta)(1 + \delta\theta^2)} \exp \frac{\theta}{\gamma(1 + \delta\theta)} > 0,$$

since $\gamma R(\theta) < \gamma R(0) = \gamma < 1$. On the right-hand side of (1.30) a straight line joins

the two points $(0, J(0))$ and $(-\gamma, J(-\gamma))$, so that (1.30) is satisfied by virtue of the convexity of $J(\theta)$. □

LEMMA 1.6. *Suppose that (1.16) is satisfied and that $\gamma < 0.45$. Then*

$$\gamma < 1 - 2p.$$

PROOF. It is easy to see that for $\delta \geq 0.5$

$$(1.31) \quad p = \frac{J(-\gamma)}{J(0)} = \frac{\xi(-\gamma)}{\xi(0)} \exp \left[-\frac{1}{1 - \delta\gamma} \right] \leq \exp \left[-\frac{1}{1 - \gamma/2} \right],$$

and that the inequality

$$\gamma + 2 \exp \left[-\frac{1}{1 - \gamma/2} \right] < 1$$

is satisfied for the indicated values of γ . □

THEOREM 1.4. *Let u be the speed of propagation of the combustion wave in problem (1.8)–(1.9). Let us assume that $1 \leq n \leq 3$, $\gamma < 0.45$, and that (1.16) is satisfied. Then*

$$u^2 \leq \frac{(2 - n)J(0)}{1 - (0.64\gamma)^{2-n}}.$$

PROOF. Since the maximum of $B(\rho(\theta), \theta)$ occurs on the interval $(-\gamma, 0)$, we have

$$(1.32) \quad \begin{aligned} u^2 &\leq \max_{\theta_c \leq \theta \leq 0} B(\rho(\theta), \theta) = \max_{-\gamma \leq \theta \leq 0} \sigma \frac{1 + \theta}{1 + \theta/\rho} \\ &\leq \max_{-\gamma \leq \theta \leq 0} \frac{\sigma}{1 + \theta/[1 + (n - 2)\sigma^{-1}J(0)(b\theta + 1)]^{1/(2-n)}} \end{aligned}$$

if σ is such that the denominators of the fractions in (1.32) are positive for all θ , $-\gamma \leq \theta \leq 0$. Let us set

$$\sigma = \frac{(2 - n)J(0)}{1 - (n - 1)b^{n-2}}.$$

Then σ is positive for $1 \leq n \leq 3$ if $\gamma < 2 - 2p$. This condition is satisfied by virtue of Lemma 1.6. To prove positivity of the denominators it is sufficient to show that the last of them in (1.32) is positive. We denote it by $f(\theta)$. Then

$$f(\theta) = 1 + \frac{\theta}{[-b\theta + (n - 1)b^{n-2}(b\theta + 1)]^{1/(2-n)}}.$$

It is easy to see that $f(0) = 1$, $f'(0) = 1$, and that $f(\theta)$ has only one minimum at

$$\theta_M = \frac{(n - 2)b^{n-3}}{1 - (n - 1)b^{n-2}}$$

and

$$f(\theta_M) = \frac{1 - b^{n-2}}{1 - (n - 1)b^{n-2}}.$$

Since $\gamma < 2 - 2p$, then $f(\theta_M) > 0$, and it follows from Lemma 1.2 that $\theta_M > -\gamma$ for $\gamma < 0.45$. Thus

$$\max_{-\gamma \leq \theta \leq 0} \frac{\sigma}{f(\theta)} = \frac{(2 - n)J(0)}{1 - b^{n-2}}$$

and

$$u^2 \leq \frac{(2-n)J(0)}{1 - [(1-p)/\gamma]^{n-2}} \leq \frac{(2-n)J(0)}{1 - (0.64\gamma)^{2-n}}$$

by virtue of (1.31). This completes the proof of the theorem. □

REMARK 1. In case $0.45 < \gamma < 1$ we can set

$$\sigma = J(0)[1 - (n-1)p]$$

and, following similar arguments, we obtain

$$u^2 \leq \frac{J(0)[1 - (n-1)p]}{1 - \gamma[(1-p(n-1))/(1-p)]^{1/(n-2)}}.$$

REMARK 2. The above analysis allows us to present an approximate formula for the speed of the combustion wave:

$$u^2 = \frac{(2-n)J(0)}{1 - \gamma^{2-n}} \quad (0 \leq n \leq 3).$$

1.4. Arbitrary kinetic laws. We proceed now to estimate the speed of a combustion wave in the case of arbitrary kinetic laws. In fact, we could also consider arbitrary temperature dependences; nevertheless, for simplicity we confine the discussion to Arrhenius dependence. Thus we consider problem (1.8)–(1.9) with the function $\Phi(\theta)$ defined above, and an arbitrary function $\varphi(a)$ satisfying the conditions

$$\varphi(0) = 0, \quad \varphi(1) = 1$$

(certain other restrictions will be indicated later).

As was done above, for the test function we take a solution of the equation

$$(1.33) \quad \frac{d\rho}{d\theta} = -\frac{1}{\gamma\sigma} \frac{\varphi(\rho)\Phi(\theta)/\rho}{1 + \theta}.$$

Let

$$\Psi(\rho) = \int_{\rho}^1 \frac{\xi d\xi}{\varphi(\xi)}.$$

Then, integrating (1.33), we obtain

$$\Psi(\rho) = J(\theta)/\sigma.$$

Here the boundary condition $\rho(\theta_c) = 1$ is satisfied. For simplicity, we shall assume that $\Psi(0) < \infty$. We set

$$\sigma = J(0)/\Psi(0).$$

Then $\rho(\theta)$ is a solution of the equation

$$(1.34) \quad J(0)/\Psi(0) = J(\theta)/\Psi(\rho).$$

Since $\rho(0) = 0$, the test function is appropriate for obtaining estimates, both

from above and from below. Substituting $\rho(\theta)$ into (1.11), we obtain (1.24). The condition for positivity of the denominator in (1.24) can be written in the form

$$(1.35) \quad J(0)/\Psi(0) > J(\theta)/\Psi(-\theta) \quad (\theta_c < \theta < 0).$$

From this, as we did above, we can conclude that

$$B(\rho(\theta), \theta) \geq \sigma$$

and, consequently,

$$u^2 \geq J(0)/\Psi(0).$$

To obtain estimates from above, we estimate the roots of the equation

$$(1.36) \quad dB(\rho(\theta), \theta)/d\theta = 0,$$

and also function $\rho(\theta)$ in (1.24) by means of a linear function on this interval. The expression obtained thereby can be readily studied.

Equation (1.36) can be rewritten in the form

$$-\theta_m = g(\rho)\xi(\theta_m),$$

where

$$g(\rho) \equiv \frac{\rho^2(1-\rho)}{\varphi(\rho)\Psi(\rho)}.$$

Let

$$(1.37) \quad g_m = \max_{0 \leq \rho \leq 1} g(\rho)$$

and let us assume that condition (1.16) is satisfied. Then

$$\theta_m > -\gamma g_m$$

(compare with Lemma 1.4). As was the case above, the points at which the function on the right-hand side of (1.35) attains maxima are also situated on the interval $(-\gamma g_m, 0)$. Thus, positiveness of the denominator of B follows from the estimates presented below. Since $J''(\theta) > 0$, we have

$$\frac{J(\theta)}{J(0)} \leq 1 - \frac{\theta}{\theta_1} \left[1 - \frac{J(\theta_1)}{J(0)} \right] \quad (\theta_1 \leq \theta \leq 0),$$

where

$$\theta_1 = -\gamma g_m.$$

Taking (1.34) into account, we obtain

$$\frac{\Psi(\rho)}{\Psi(0)} \leq 1 - \frac{\theta}{\theta_1} \left[1 - \frac{J(\theta_1)}{J(0)} \right] \quad (\theta_1 \leq \theta \leq 0)$$

and, consequently,

$$-\theta \leq \frac{1}{k} \left(1 - \frac{\Psi(\rho)}{\Psi(0)} \right) \quad (\theta_1 \leq \theta \leq 0),$$

where

$$k = -[1 - J(\theta_1)/J(0)]/\theta_1.$$

Thus,

$$\begin{aligned}
 u^2 &\leq \max_{\theta_c \leq \theta \leq 0} \sigma \frac{\rho}{\rho + \theta} = \max_{\theta_1 \leq \theta \leq 0} \sigma \frac{1}{1 + \theta/\rho} \\
 &\leq \max_{0 \leq \rho \leq 1} \frac{\sigma}{1 - [1 - \Psi(\rho)/\Psi(0)]/(k\rho)}.
 \end{aligned}$$

Let

$$(1.38) \quad p_m = \max_{0 \leq \rho \leq 1} p(\rho), \quad p(\rho) = [1 - \Psi(\rho)/\Psi(0)]/\rho.$$

Then

$$u^2 \leq \frac{\sigma}{1 - \gamma g_m p_m / [1 - J(\theta_1)/J(0)]} \leq \frac{\sigma}{1 - \gamma g_m p_m / [1 - \exp(-g_m)]}.$$

As a result of these considerations, we have the following theorem.

THEOREM 1.5. *Let u be the speed of the combustion wave in problem (1.8)–(1.9) with the arbitrary kinetics $\varphi(a)$ satisfying the conditions formulated above. Let us assume that (1.16) is satisfied and that*

$$\gamma < \min \left[\frac{1 - \exp(-g_m)}{g_m p_m}, 1 \right],$$

where g_m, p_m are given by formulas (1.37), (1.38). Then

$$(1.39) \quad \frac{J(0)}{\Psi(0)} \leq u^2 \leq \frac{J(0)/\Psi(0)}{1 - \gamma g_m p_m / [1 - \exp(-g_m)]}.$$

For γ sufficiently small, (1.39) gives an accurate approximation for the propagation velocity.

We apply the results obtained to the case of exponential kinetics:

$$\varphi(a) = \exp[-m(1 - a)] \quad (a > 0),$$

$$\varphi(a) = 0 \quad (a < 0).$$

We have

$$\begin{aligned}
 \Psi(\rho) &= [(1 + m\rho) \exp(m(1 - \rho)) - (1 + m)]/m^2, \\
 (1.40) \quad g(\rho) &= m^2 \frac{\rho^2(1 - \rho)}{(1 + m\rho) - (1 + m) \exp[-m(1 - \rho)]}, \\
 p(\rho) &= \frac{1 - (1 + m\rho) \exp(-m\rho)}{[1 - (m + 1) \exp(-m)]\rho},
 \end{aligned}$$

and the problem consists in finding g_m and p_m .

LEMMA 1.7. *If $m \leq 3$, then $g_m = 1$. For $m > 3$*

$$g_m \leq A_m = (3 + m)^2 / (4m) - 2.$$

PROOF. Inequality $g(\rho) \leq 1$ is equivalent to

$$(1.41) \quad r(x) \geq 1,$$

where

$$x = 1 - \rho, \quad r(x) = \left[1 - mx + \frac{2m^2x^2}{1+m} - \frac{m^2x^3}{1+m} \right] \exp(mx).$$

Since $r(0) = 1$, $r'(x) \geq 0$ for $0 \leq x \leq 1$, $m \leq 3$, formula (1.41) is satisfied. Consider the case $m > 3$. We have $g(0) = 0$, $g(1) = 1$, and from

$$g'(\rho_*) = 0$$

it follows that

$$(1.42) \quad (1 + m) \exp[-m(1 - \rho_*)] = \frac{2m\rho_*^2 + (3 - m)\rho_* - 2}{-m\rho_*^2 + (3 + m)\rho_* - 2}.$$

Substituting (1.42) into (1.40), we obtain

$$g(\rho_*) = -m\rho_*^2 + (3 + m)\rho_* - 2 \leq A_m. \quad \square$$

LEMMA 1.8. *Let x_* be a positive solution of the equation*

$$\exp x = x^2 + x + 1$$

($x_* \approx 1.793$). *Then*

$$p_m = 1 \quad (m \leq x_*),$$

$$p_m = m\zeta(x_*) / [1 - (m + 1) \exp(-m)] \quad (m > x_*),$$

where

$$\zeta(x) = [1 - (1 + x) \exp(-x)] / x.$$

PROOF. Function $p(\rho)$ can be written in the form

$$p(\rho) = m\zeta(m\rho) / [1 - (m + 1) \exp(-m)].$$

Consequently,

$$p_m = \max_{0 \leq m\rho \leq m} \zeta(m\rho)m / [1 - (m + 1) \exp(-m)].$$

It is easy to see that function $\zeta(x)$ increases monotonically for $x < x_*$ and decreases for $x > x_*$. Consequently,

$$\max_{0 \leq m\rho \leq m} \zeta(m\rho) = \zeta(m) \quad (m < x_*),$$

$$\max_{0 \leq m\rho \leq m} \zeta(m\rho) = m\zeta(x_*) / [1 - (m + 1) \exp(-m)] \quad (m > x_*),$$

and the lemma is proved ($\zeta(x_*) = 0.298$). □

As a result, we have

$$(1.43) \quad \frac{m^2 J(0)}{\exp(m) - (m+1)} \leq u^2 \leq \frac{m^2 J(0)}{\exp(m) - (m+1)} \frac{1}{1 - \gamma c_m},$$

where

$$c_m = e/(e-1) \approx 1.582 \quad (m < x_*),$$

$$c_m = 1.582 m \zeta(x_*) / [1 - (m+1) \exp(-m)] \quad (x_* \leq m \leq 3),$$

$$c_m = A_m m \zeta(x_*) / [1 - (m+1) \exp(-m)] / [1 - \exp(-A_m)] \quad (m > 3).$$

In particular,

$$c_1 \approx 1.582, \quad c_2 \approx 1.587, \quad c_3 \approx 1.766, \quad c_4 \approx 2.130, \quad c_{10} \approx 7.438.$$

The larger the value of m , the less accurate the estimates (1.43) turn out to be. This is connected with the fact that the test function constructed above is designed for a narrow reaction zone. For large m the reaction zone becomes wide, a case to be examined in the next section.

1.5. Estimates of the speed of a combustion wave for exponential kinetics. In this case it is convenient to use the following dimensionless variables and parameters:

$$\begin{aligned} \theta &= (T - T_*)/q, & \gamma &= (RT_*^2)/(Eq), & \delta &= q/T_*, & \theta_i &= (T_i - T_*)/q, \\ \theta_c &= (T_c - T_*)/q, & \theta_b &= (T_b - T_*)/q, & h &= \theta_c - \theta_i, \\ u &= v[m\kappa k_0 \exp(-m + m\theta_b - E/RT_*)]^{-1/2}. \end{aligned}$$

The scaling temperature T_* is specified by the equation $m = RT_*^2/Eq$. Then (1.3)–(1.4) may be written in the form

$$\begin{aligned} \frac{da}{d\theta} &= -\frac{1}{u^2} \frac{\exp[ma - m\theta_b + m\theta/(1 + \delta\theta)]}{ma - m\theta_b + m\theta}, \\ a(\theta_c) &= 1, \quad a(\theta_b) = 0. \end{aligned}$$

To obtain estimates from above, we take as test function the solution of the equation

$$(1.44) \quad \frac{d\rho}{d\theta} = -\frac{1}{\sigma} \frac{\exp[m(\rho + \theta - \theta_b)]}{m(\rho + \theta - \theta_b)},$$

$$(1.45) \quad \rho(\theta_c) = 1, \quad \rho(\theta_b) = 0.$$

Parameter σ must also be found from (1.44)–(1.45). It is easy to show that $\sigma < e$. Indeed, let

$$y(\theta) = \rho(\theta) + \theta - \theta_b.$$

Then (1.44)–(1.45) takes the form

$$(1.46) \quad \begin{aligned} \frac{dy}{d\theta} &= 1 - \frac{1}{\sigma} \frac{\exp(my)}{my}, \\ y(\theta_c) &= h, \quad y(\theta_b) = 0. \end{aligned}$$

Integrating (1.46) from θ_c to θ_b , we obtain

$$(1.47) \quad \sigma \int_0^{mh} \frac{x dx}{\exp(x) - \sigma x} = m(1 - h).$$

For simplicity, we shall assume that $mh > 1$. It then follows from (1.47) that $\sigma < e$. In the opposite case the integral in (1.47) does not exist. In fact, for m large, σ can be found more precisely. Without going into the details, we give the result:

$$\sigma \approx e[1 - 2\pi^2/m^2(1 - h)^2] \quad (m \gg 1).$$

Substituting $\rho(\theta)$ specified by (1.44), (1.45) into $B(\rho(\theta), \theta)$, we obtain

$$B(\rho(\theta), \theta) \equiv -\frac{\exp[m\rho - m\theta_b + m\theta/(1 + \delta\theta)]}{m(\rho + \theta - \theta_b)d\rho/d\theta} = \sigma \exp\left[-\frac{m\delta\theta^2}{1 + \delta\theta}\right] \leq \sigma \leq e.$$

Consequently, $u^2 \leq e$, and in dimensional form we have

$$v^2 \leq \varkappa mk_0 \exp\left[1 - 2\left(\frac{Em}{Rq}\right)^{1/2} + mT_i/q\right].$$

To obtain estimates from below we consider the problem

$$(1.48) \quad \begin{aligned} \frac{d\rho}{d\theta} &= -\frac{1}{\sigma} \frac{\exp[m\rho - m\theta_b + m\theta/(1 + \delta\theta)]}{m(\rho - \theta_b)}, \\ \rho(\theta_c) &= 1, \quad \rho(0) = \theta_b. \end{aligned}$$

Obtaining σ from (1.48), we have

$$\begin{aligned} \sigma &= \int_{\theta_c}^0 \exp[-m\theta_b + m\theta/(1 + \delta\theta)] d\theta / \int_{\theta_b}^1 m(\rho - \theta_b) \exp(-m\rho) d\rho \\ &= m \int_{\theta_c}^0 \exp[m\theta/(1 + \delta\theta)] d\theta / \{1 - [1 + m(1 - \theta_b)] \exp[-m(1 - \theta_b)]\}. \end{aligned}$$

For m sufficiently large

$$m \int_{\theta_c}^0 \exp[m\theta/(1 + \delta\theta)] d\theta \approx 1$$

and

$$\sigma \approx \frac{1}{1 - [1 + m(1 - \theta_b)] \exp[-m(1 - \theta_b)]} > 1.$$

Substituting ρ defined by (1.48) into $B(\rho(\theta), \theta)$, we find

$$B(\rho(\theta), \theta) = \sigma \frac{\rho - \theta_b}{\rho + \theta - \theta_b} > \sigma > 1.$$

Thus $u^2 > 1$ and we have, finally,

$$\varkappa mk_0 \exp\left[-2\left(\frac{Em}{Rq}\right)^{1/2} + mT_i/q\right] \leq v^2 \leq \varkappa mk_0 \exp\left[1 - 2\left(\frac{Em}{Rq}\right)^{1/2} + mT_i/q\right].$$

§2. Estimates for the speed of a gas combustion wave

2.1. Minimax method. Test function. In this section we apply the minimax method for a single-stage n th order reaction in the case of similarity of the

temperature and concentration fields (i.e., for equality of the coefficients of thermal diffusivity and diffusion).

In coordinates connected with the wave, the stationary system of equations has the form

$$(2.1) \quad \varkappa T'' + vT' + qa^n k(T) = 0,$$

$$(2.2) \quad da'' + va' - a^n k(T) = 0,$$

where T is the temperature, a is the concentration of the initial substance; \varkappa and d are the coefficients of thermal diffusivity and diffusion respectively; q is the adiabatic heating of the reaction; n is the order of reaction; v is the wavespeed; and

$$k(T) = \begin{cases} k_0 \exp(-E/RT) & (T \geq T_*) \\ 0 & (T_i \leq T \leq T_*) \end{cases}$$

E is the activation energy; R is the gas constant; k_0 is a pre-exponential factor; T_i is the initial temperature; T_* is the magnitude of "cut-off" in the source;

$$x = -\infty: T = T_b \equiv T_i + q, \quad a = 0; \quad x = +\infty: T = T_i, \quad a = 1.$$

In the case $\varkappa = d$, as is readily seen, $T = T_b - qa$ and the system of equations (2.1), (2.2) is reduced to a single equation

$$\varkappa T'' + vT' + q \left(\frac{T_b - T}{q} \right)^n k(T) = 0.$$

Making variables and parameters dimensionless,

$$\gamma = \frac{RT_b^2}{E(T_b - T_i)}, \quad \beta = \frac{RT_b}{E}, \quad \theta = \frac{T - T_b}{T_b - T_i}, \quad k_* = \gamma k_0 \exp(-E/RT_b),$$

$$u = v/\sqrt{\varkappa k_*}, \quad \xi = x\sqrt{k_*/\varkappa},$$

we obtain

$$(2.3) \quad \theta'' + u\theta' + (-\theta)^n \tilde{k}(\theta)/\gamma = 0.$$

Here the prime indicates differentiation with respect to ξ ,

$$\tilde{k}(\theta) = \begin{cases} \exp \frac{\theta}{\gamma + \beta\theta} & (\theta_* \leq \theta \leq 0), \\ 0 & (-1 \leq \theta < \theta_*), \end{cases}$$

$\theta_* = (T_* - T_b)/(T_b - T_i)$. Conditions at infinity have the form

$$(2.4) \quad \theta(-\infty) = 0, \quad \theta(+\infty) = -1.$$

We go from equation (2.3) to a system of two first order equations

$$\theta' = p, \quad p' = -up - (-\theta)^n \tilde{k}(\theta)/\gamma,$$

whence we obtain the equation

$$(2.5) \quad \frac{dp}{d\theta} = -u - (-\theta)^n \tilde{k}(\theta)/(\gamma p)$$

with boundary conditions

$$(2.6) \quad p(-1) = p(0) = 0.$$

We make the change of variables

$$\theta + p/u = -a.$$

We have

$$(2.7) \quad \frac{da}{d\theta} = -\frac{1}{\gamma u^2} \frac{(-\theta)^n \tilde{k}(\theta)}{a + \theta}, \quad a(\theta_*) = 1, \quad a(0) = 0.$$

We note that this equation resembles that which is obtained for a zero coefficient of diffusion (see §1). The difference is that on the right-hand side of (2.7) we have $(-\theta)^n$ instead of a^n .

As we have already remarked several times, selection of a test function does not require a formal justification; however, a test function must express the characteristic properties of solutions, otherwise the estimates will be poor. In the given case, in choosing the test function we employ the following considerations. We consider equation (2.7) as an equation for $d = 0$ with a zero order reaction (with respect to a) and a somewhat modified temperature dependence for the reaction rate. We construct the test function as was done in §1 for a zero order reaction: we rewrite (2.7) in the form

$$(2.8) \quad a \frac{da}{d\theta} = -\frac{1}{\gamma u^2} \frac{(-\theta)^n \exp \frac{\theta}{\gamma + \beta \theta}}{1 + \theta/a},$$

and replace θ/a at the right by θ , assuming that $a(\theta)$ is different from 1 only in a narrow interval close to $\theta = 0$; we then solve the resulting equation, using the boundary condition on the left. Thus we obtain the test function

$$(2.9) \quad \rho(\theta) = \sqrt{1 - 2J_n(\theta)/\sigma},$$

where

$$(2.10) \quad J_n(\theta) = \frac{1}{\gamma} \int_{\theta_*}^{\theta} \frac{(-\tau)^n \exp \frac{\tau}{\gamma + \beta \tau}}{1 + \tau} d\tau$$

and σ is a parameter whose value is selected for obtaining best estimates.

We consider, further, the function

$$(2.11) \quad B(\theta, \rho(\theta)) = -\frac{1}{\gamma} \frac{(-\theta)^n \exp \frac{\theta}{\gamma + \beta \theta}}{(\rho + \theta)d\rho/d\theta}.$$

Then, by virtue of the minimax method,

$$(2.12) \quad \min_{\theta_* \leq \theta \leq 0} B(\theta, \rho(\theta)) \leq u^2 \leq \max_{\theta_* \leq \theta \leq 0} B(\theta, \rho(\theta)).$$

We recall that to obtain estimates from above function $\rho(\theta)$ must satisfy the conditions

$$(2.13) \quad \rho(\theta) + \theta > 0 \quad \text{for } \theta_* < \theta < 0,$$

and, for estimates from below,

$$(2.14) \quad \rho(\theta) + \theta > 0 \quad \text{for } \theta_* < \theta < \theta_0 \leq 0, \quad \rho(\theta_0) = \theta_0$$

(if $\theta_0 < 0$, then the minimum in (2.12) is taken over the interval $\theta_* \leq \theta \leq \theta_0$). Substituting (2.9), (2.10) into (2.11), we obtain

$$(2.15) \quad B(\theta, \rho(\theta)) = \sigma \frac{(1 + \theta)\rho}{\theta + \rho}.$$

We note that

$$\frac{d\rho}{d\theta} = -\frac{1}{\gamma\sigma} \frac{(-\theta)^n \exp \frac{\theta}{\gamma + \beta\theta}}{(1 + \theta)/\rho},$$

therefore, for $\sigma = 2J(0)$, $\rho(0) = 0$ and $\rho'(0) = 1/\sqrt{2J(0)\gamma}$ for $n = 1$ and $\rho'(0) = 0$ for $n > 1$.

2.2. Estimates of the speed from below. It is easy to see that $B \geq \sigma$ for $\theta + \rho > 0$. Therefore, setting $\sigma = 2J_n(0)$, we obtain an estimate from below:

$$(2.16) \quad u^2 \geq \frac{2}{\gamma} \int_{\theta_*}^0 \frac{(-\tau)^n \exp \frac{\tau}{\gamma + \beta\tau}}{1 + \tau} d\tau.$$

We note that the narrow reaction zone method also yields an estimate of the speed from below (see [Zel 5, Vag 1]):

$$u^2 > 2\tilde{J}_n = \frac{2}{\gamma} \int_{\theta_*}^0 (-\tau)^n \exp \frac{\tau}{\gamma + \beta\tau} d\tau.$$

It is easy to see that $J_n > \tilde{J}_n$, i.e., the estimate (2.16) is more precise than that obtained by the narrow zone method. Moreover, if for condensed system ($d = 0$) the difference between these estimates is small, then, in the case of the combustion of gases, this difference can be substantial. For example, for $\gamma = 0.1$, $\theta_* = -0.9$, $\beta = 0$, and $n = 1$, we have $J_1 \approx 0.13$, $\tilde{J}_1 \approx 0.10$, and for $n = 2$, $J_2 \approx 0.031$, $\tilde{J}_2 \approx 0.020$. Thus, for $n = 2$ these estimates already differ by a factor of 1.5, whereby, as n increases, the difference increases. For $n = 0$ the estimate (2.16) coincides with the estimate for $d = 0$.

Before presenting yet another estimate from below, we note that to satisfy inequality (2.13) it is obviously sufficient that the following inequality be satisfied:

$$(2.17) \quad \sigma > \frac{2J_n(\theta)}{1 - \theta^2} \equiv \Phi(\theta) \quad (\theta_* \leq \theta < 0).$$

If inequality (2.17) is not satisfied, and if for some $\theta = \tilde{\theta}$ we have the equality $\sigma = \Phi(\tilde{\theta})$, then the estimate of the speed from below, namely, $u^2 \geq \Phi(\tilde{\theta})$, follows from the inequality $B \geq \sigma$. Since σ can be selected arbitrarily, for arbitrary θ the following inequality is obviously satisfied:

$$u^2 \geq \frac{2J_n(\theta)}{1 - \theta^2}$$

(cf. §1).

2.3. Estimates from above for $0 \leq n \leq 1$. As in the case of a condensed medium, when $n = 1$ and with a corresponding choice of σ , the function $B(\theta, \rho(\theta))$ is a monotone function of θ upon the fulfillment of certain conditions on the parameters of the problem. It attains its smallest value for $\theta = \theta_* \equiv -1 + h$, and its largest value for $\theta = 0$. This makes it possible to calculate its minimum and maximum explicitly for $\theta_* \leq \theta \leq 0$.

Thus, we consider $B(\theta, \rho(\theta))$ as a function of θ for $n = 1, \sigma = 2J_1(0)$. Equating the derivative of B to zero, we obtain the equation

$$F(y) \equiv 2I_1(0) \left[1 - \frac{I_1(y)}{I_1(0)} \right] \left[1 - \sqrt{1 - \frac{I_1(y)}{I_1(0)}} \right] - y^2 \Phi(y) = 0,$$

where

$$I_1(y) = \int_{(-1+h)/\gamma}^y \frac{(-\tau)\Psi(\tau)}{1 + \gamma\tau} d\tau, \quad \Psi(y) = \exp \frac{y}{1 + \beta y}, \quad y = \frac{\theta}{\gamma}.$$

It is easy to see that $F(0) = 0, F((-1 + h)\gamma) < 0$. Function F will therefore be negative on the half-interval $(-1 + h)\gamma < y \leq 0$ if it is negative at the extremum points. From the equation $F'(y) = 0$ we obtain

$$\rho(y) \equiv \sqrt{1 - \frac{I_1(y)}{I_1(0)}} = -\frac{2\gamma y}{3} - \frac{y(1 + \gamma y)}{3(1 + \beta y)^2}.$$

Substituting into the expression for $F(y)$ the value of $\rho(y)$ found at the extremum points, and requiring the resulting function to be negative, we obtain the condition

$$(2.18) \quad \frac{2}{27} I_1(0) z^2 (3 + yz) - \exp \left(\frac{y}{1 + \beta y} \right) < 0,$$

where

$$(-1 + h)/\gamma \leq y \leq 0, \quad z = 2\gamma + (1 + \gamma y)(1 + \beta y)^{-2},$$

upon whose fulfillment function B is monotone. It is easy to see that for $\gamma = 0$ this inequality has the form

$$2 + 2y/3 < 9e^y$$

and is satisfied for all y ($I_1(0) \rightarrow 1$ as $\gamma \rightarrow 0$). We can therefore assume that (2.18) is satisfied also for small γ .

Condition (2.18) is an explicitly verifiable condition on the parameters γ, β , and h , although fairly involved. It can be established analytically under certain conditions; however, it can also be verified numerically. One of the results of a numerical verification is that (2.18) is satisfied in case $\beta = \gamma < 1$. Here we have used the estimates

$$I_1(0)|_{h \neq 0} < I_1(0)|_{h=0} = -\frac{1}{\gamma^2} + \frac{1}{\gamma} \left(1 + \frac{1}{\gamma} \right) \psi \left(\frac{1}{\gamma} \right) \leq \frac{1 + 2\gamma}{1 + 6\gamma + 6\gamma^2},$$

where

$$\psi(\eta) = \eta e^\eta E_1(\eta), \quad E_1(\eta) = \int_\eta^\infty e^{-t} \frac{dt}{t}, \quad \psi(\eta) \leq \frac{\eta^2 + 5\eta + 2}{\eta^2 + 6\eta + 6}$$

(see [Vol 34, Abr 1]).

Thus, under the above conditions on the parameters, we have the estimate

$$(2.19) \quad 2J_1(0) \leq u^2 \leq \frac{2J_1(0)}{1 - \sqrt{2J_1(0)\gamma}}.$$

Since $J_1(0) \approx \gamma$ for γ small, the ratio of the estimate from below to the estimate from above is of order $1 - \gamma\sqrt{2}$.

We now obtain a similar estimate for $0 \leq n \leq 1$. To do this we first establish the inequality

$$p_n(\theta) \leq p_1(\theta), \quad -1 + h \leq \theta \leq 0, \quad n < 1,$$

where $p_n(\theta) = J_n(\theta)/J_n(0)$. Actually, $p_n(-1 + h) = p_1(-1 + h)$, $p_n(0) = p_1(0)$. If we assume that $p_n(\theta) = p_1(\theta)$ at some intermediate point, the equation $p'_n(\theta) = p'_1(\theta)$ will then have at least two solutions in the interval $-1 + h < \theta < 0$, which is not possible. It may be easily verified that close to zero $p_n < p_1$. Consequently, this inequality is satisfied over the whole interval.

We have

$$B = 2J_n(0) \frac{1 + \theta}{1 + \frac{\theta}{\sqrt{1 - J_n(\theta)/J_n(0)}}} \leq 2J_n(0) \frac{1 + \theta}{1 + \frac{\theta}{\sqrt{1 - J_1(\theta)/J_1(0)}}}.$$

Using the monotonicity of B for $n = 1$, we obtain the estimate

$$2J_n(0) \leq u^2 \leq \frac{2J_n(0)}{1 - \sqrt{2J_1(0)\gamma}}, \quad 0 \leq n \leq 1,$$

which is valid for the same values of the parameters γ , β , and h as the estimate (2.19).

2.4. Estimates from above for arbitrary n . We shall assume that $\sigma > 2J_n(0)$. Here $\rho(0) > 0$ and $B(-1 + h) = B(0) = \sigma$, and, when inequality (2.17) is satisfied, $B \geq \sigma$ for $-1 + h \leq \theta \leq 0$. Therefore function B has a maximum on this interval, which it is sufficient to estimate from above. We first estimate the interval on which the extrema of function B are situated. From the equation $B' = 0$ we obtain

$$(2.20) \quad \eta(\theta) \frac{2\rho^2}{1 + \rho} = -\theta,$$

where

$$\eta(\theta) = (-\theta)^{-n} \gamma J_n(\theta) e^{-\theta/(\gamma + \beta\theta)}.$$

Since for $0 \leq \rho \leq 1$

$$0 \leq \frac{2\rho^2}{1 + \rho} \leq 1,$$

then all solutions of equation (2.20) lie on the interval $\theta_1 \leq \theta \leq 0$, where θ_1 is the solution of equation

$$(2.21) \quad \eta(\theta) = -\theta,$$

largest in absolute value. We present two ways to estimate solutions of equation (2.21).

1) We estimate function $\eta(\theta)$ from above. To do this, we note that the derivative $\eta'(\theta)$ vanishes for

$$\eta(\theta) = P(\theta) \equiv \gamma \frac{(-\theta)(1 + \delta\theta)^2}{(1 + \theta)[- \theta - \gamma n(1 + \delta\theta)^2]}.$$

It is easily verified that when conditions

$$(2.22) \quad h > \frac{1 - \delta}{\delta}$$

and

$$(2.23) \quad \gamma n < \frac{(1 - h)(1 + h)^2}{4h^2}$$

are satisfied, $P(\theta)$ is a monotonically increasing function with a discontinuity at $\theta = \theta_*$, $-1 + h < \theta_* < 0$, $P(\theta) > 0$ for $-1 + h \leq \theta < \theta_*$, $P(\theta) \leq 0$ for $\theta_* < \theta \leq 0$. Since $\eta(-1 + h) = 0$, then

$$\eta(\theta) < P(\theta), \quad -1 + h \leq \theta \leq \theta_*.$$

Therefore, solutions of equation (2.21) may be estimated from below by means of the solution of the equation

$$P(\theta) = -\theta,$$

which can be rewritten in the form

$$(2.24) \quad \gamma(1 + \delta\theta)^2 \left[n + \frac{1}{1 + \theta} \right] = -\theta.$$

If inequality

$$(2.25) \quad 1 - h > \gamma(n + 1)$$

is satisfied ((2.23) follows from (2.25)), then equation (2.24) has a unique solution on the interval $-1 + h \leq \theta \leq 0$, and for this solution θ we have

$$(2.26) \quad \theta > -(n + 1)\gamma$$

if

$$\gamma(1 - (n + 1)\gamma\delta)^2 \left[n + \frac{1}{1 - (n + 1)\gamma} \right] < (n + 1)\gamma$$

or, after transforming this inequality, if

$$(2.27) \quad \delta(n + 1)(2 - \gamma\delta(n + 1))(1 - \gamma n) > 1.$$

For example, for $n = 1$, $\delta = 1$ this condition is satisfied if $\gamma < 0.25$.

Thus, when conditions (2.22), (2.25), (2.27) are satisfied, the maximum point of function B satisfies inequality (2.26).

2) We write equation (2.21) in the form

$$(2.28) \quad \xi(\theta) = (-\theta)^{n+1},$$

where $\xi(\theta) = \gamma J(\theta)e^{-\theta/(\gamma + \beta\theta)}$. From the equation $\xi'(\theta) = 0$ it follows that

$$(2.29) \quad \xi(\theta) = (-\theta)^n(\gamma + \beta\theta)^2/(\gamma(1 + \theta)).$$

To simplify things, we confine the discussion to the case $\beta = \gamma$ ($\delta = 1$), although

this is not mandatory. Since the function on the right of (2.29) has the maximum value $\gamma n^n(n+1)^{-(n+1)}$, it follows that

$$\xi(\theta) \leq \gamma n^n(n+1)^{-(n+1)}, \quad -1+h \leq \theta \leq 0.$$

Consequently, solutions of equation (2.28) and the extrema of function B satisfy the condition

$$(2.30) \quad \theta \geq -\frac{n}{n+1} \left(\frac{\gamma}{n}\right)^{1/(n+1)}.$$

We note that the extrema of function Φ satisfy the equation

$$(-\theta)^{n+1} = \xi(\theta) \frac{2\theta^2}{1-\theta}$$

and, by virtue of the same considerations, are situated on the same interval as the extrema of function B . Therefore, if function B is positive and bounded from above on this interval, then inequality (2.17) is valid on this interval and, consequently, it is valid for all θ .

Let us estimate function B on the interval $\theta_2 \leq \theta \leq 0$ for some $\theta_2, -1+h < \theta_2 < 0$. We consider first the simplest estimate. Since $J_n(\theta) \leq J_n(0)$, we have

$$B \leq \sigma \frac{1+\theta}{1+\theta(1-2J_n(0)/\sigma)^{-1/2}} \leq \sigma \frac{1+\theta_2}{1+\theta_2(1-2J_n(0)/\sigma)^{-1/2}}.$$

Setting, for example, $\sigma = 2J_n(0)/(1+\theta_2)^{-1}$, we obtain

$$(2.31) \quad B \leq 2J_n(0)/(1-(-\theta_2)^{1/2}).$$

We show how this estimate can be improved, using as an example a reaction of the first order ($n = 1$). To do this, we use the inequality ($\beta \geq 0.5\gamma$)

$$J_1(\theta) \leq J_1(0)(1+\theta)/(1-\gamma),$$

which follows from the fact that $J_1(\theta) \leq J_1(0)$ and the derivative $J_1''(\theta)$ is positive for $\theta \leq -\gamma$. For $\beta \geq 0.5\gamma$ we have

$$B \leq \sigma \frac{1+\theta}{1+\theta(1-b(1+\theta))^{-1/2}},$$

where $b = 2J_1(0)/(\sigma(1-\gamma))$. Let us take $\sigma = 2J_1(0)/(1-\gamma)$. Then

$$B \leq 2J_1(0)(1+(-\theta)^{1/2})/(1-\gamma).$$

Thus,

$$(2.32) \quad B \leq 2J_1(0)(1+(-\theta_2)^{1/2})/(1-\gamma).$$

This approach can also be used for other n .

From (2.26), (2.30), (2.32) we obtain the following estimates:

$$2J_n(0) \leq u^2 \leq 2J_n(0) \frac{1}{1 - \sqrt{(n+1)\gamma}}$$

(when (2.22), (2.25), (2.27) are satisfied) and

$$2J_n(0) \leq u^2 \leq 2J_n(0) \frac{1}{1 - \sqrt{\frac{n}{n+1} \left(\frac{\gamma}{n}\right)^{1/(n+1)}}}$$

(for $\beta = \gamma$). For $n = 1$ and under similar conditions

$$2J_1(0) \leq u^2 \leq 2J_1(0) \frac{1 + \sqrt{0.5\sqrt{\gamma}}}{1 - \gamma}$$

(for $\beta = \gamma$) and

$$2J_1(0) \leq u^2 \leq 2J_1(0) \frac{1 + \sqrt{2\gamma}}{1 - \gamma}$$

(for $\beta \geq 0.5\gamma$ and when (2.22), (2.25), (2.27) are satisfied).

In particular, these estimates imply the following asymptotics of the speed:

$$(2.33) \quad u^2 \sim 2J_n(0) \sim a_n \gamma^n \quad \text{as } \gamma \rightarrow 0,$$

where

$$a_n = \int_{-\infty}^0 (-\tau)^n e^\tau d\tau$$

($a_n = n!$ for integer n), since the asymptotics of estimates from above and from below agree with one another and coincide with (2.33).

§3. Determination of asymptotics of the speed by the method of successive approximations

3.1. Introduction. As in §1, we consider the system of equations

$$(3.1) \quad \begin{aligned} \theta'' - u\theta' + \frac{1}{\gamma} a^n \Phi(\theta) &= 0, \\ ua' + \frac{1}{\gamma} a^n \Phi(\theta) &= 0. \end{aligned}$$

Here θ is the dimensionless temperature; a is the concentration of the initial reactant; u is the wavespeed; primes indicate differentiation with respect to the spatial variable x ; and

$$(3.2) \quad \Phi(\theta) = \begin{cases} 0 & (-1 \leq \theta < -1 + h), \\ \exp \frac{\theta}{\gamma + \beta\theta} & (-1 + h \leq \theta \leq 0). \end{cases}$$

Parameters β , γ , and h were defined in §1; n is the order of the reaction. Boundary conditions as $x \pm \infty$ have the form

$$\theta(-\infty) = -1, \quad a(-\infty) = 1; \quad \theta(+\infty) = 0.$$

The method of successive approximations makes it possible to obtain estimates of the speed from above and from below; moreover, a fortunate choice of an initial approximation yields agreement in the asymptotics of estimates of the speed from

above and from below already for first approximations, making it possible to obtain asymptotics of the speed. Asymptotics of the speed of a combustion wave for the indicated model was considered in [Berm 2, Gal 1, Il 4, Khu 2]. At the present time we can consider as solved the problem of determining the two leading terms of a nonuniform asymptotics when $n < 2$. Nonuniformity of the asymptotics is to be understood here in the following sense: the limit of the asymptotics with respect to small γ as $n \rightarrow 2$ is equal to zero and does not coincide with the asymptotics with respect to γ obtained for $n = 2$. Such a situation is typical for the case of an application of the method of matched asymptotic expansions in powers of γ . The origin of nonuniformity of the asymptotics is easily observed in the function

$$P(\gamma) = \frac{(2 - n)J(0)}{1 - \gamma^{2-n}}.$$

In §1 it was shown that this function yields a good approximation for the square of the speed. Expansion of $P(\gamma)$ in series in powers of the small parameter γ yields, in the leading terms,

$$P(\gamma) \sim (2 - n)(1 + \gamma^{2-n}) \rightarrow 0 \quad \text{as } n \rightarrow 2,$$

while $P(\gamma) = 1/\ln(1/\gamma)$ for $n = 2$.

The method of successive approximations makes it possible to construct a uniform asymptotics for $n \leq 2$.

3.2. Realization of the method of successive approximations for $0 \leq n \leq 1$. The system of equations (3.1) has a first integral and can be reduced to a single equation in the usual way:

$$(3.3) \quad \frac{da}{d\theta} = -\frac{1}{\gamma u^2} \frac{a^n \exp(\theta/(\gamma + \beta\theta))}{a(\theta) + \theta}$$

with boundary conditions

$$(3.4) \quad a(-1 + h) = 1, \quad a(0) = 0.$$

Here θ is a new independent variable, $-1 + h \leq \theta \leq 0$, $a(\theta)$ is the unknown function. From (2.1), (2.2) we readily obtain

$$(3.5) \quad a^{2-n}(\theta) = 1 - \frac{2 - n}{\gamma u^2} \int_{-1+h}^{\theta} \frac{\exp(\tau/(\gamma + \beta\tau))}{1 + \tau/a} d\tau,$$

$$(3.6) \quad u^2 = \frac{2 - n}{\gamma} \int_{-1+h}^{\theta} \frac{\exp(\tau/(\gamma + \beta\tau))}{1 + \tau/a} d\tau.$$

Let us set

$$(3.7) \quad a_{i+1}^{2-n}(\theta) = 1 - \frac{2 - n}{\gamma u^2} \int_{-1+h}^{\theta} \frac{\exp(\tau/(\gamma + \beta\tau))}{1 + \tau/a_i(\tau)} d\tau, \quad a_0(\theta) \equiv 1.$$

Since $a_0(\theta) \geq a(\theta)$ for $-1 + h \leq \theta \leq 0$, then, by virtue of (3.5), (3.7), $a(\theta) \leq a_1(\theta) \leq a_0(\theta)$ for $-1 + h \leq \theta \leq 0$. From this, by induction,

$$(3.8) \quad a(\theta) \leq a_{i+1}(\theta) \leq a_i(\theta) \quad (-1 + h \leq \theta \leq 0).$$

We denote by $\tilde{a}(\theta)$ the limit of the sequence of functions $\{a_i(\theta)\}$. Upon passing to the limit in equation (3.7) (we can pass to the limit under the integral sign by Lebesgue's theorem, using inequality (3.8)), we find that \tilde{a} satisfies equation (3.5)

and, consequently, equation (3.3). It is also clear that if u is the wavespeed, then $\tilde{a}(-1+h) = 1, \tilde{a}(0) = 0$.

Thus we have obtained a decreasing sequence of functions, converging to the solution, and a corresponding sequence of inequalities for the speed

$$(3.9) \quad u^2 > F_i(u^2) \equiv \frac{2-n}{\gamma} \int_{-1+h}^0 \frac{\exp(\tau/(\gamma + \beta\tau))}{1 + \tau/a_i(\tau)} d\tau \quad (i = 0, 1, 2, \dots),$$

the right-hand sides of which are functions of u^2 . It is easy to see that the F_i decrease monotonically with respect to u^2 and that $F_{i+1} > F_i$. If we denote by u_i^2 the solution of the equation

$$(3.10) \quad u^2 = F_i(u^2),$$

then for the functions (3.7) we have $a_{i+1}(0) = 0$, where we have replaced u by u_i . Therefore, function $F_{i+1}(u^2)$ is defined for $u^2 > u_i^2$. Thus, a solution of equation (3.10) exists, is unique, and the sequence of numbers $\{u_i\}$ converges, increasing, to the value of the speed.

We note that the successive approximations (3.7) are defined and converge to the solution for arbitrary values of $n \geq 0$; however, expression (3.6) for the speed and inequalities (3.9) are valid only for $n < 2$.

Along with the functions $a_i(\theta)$ we define the functions $\alpha_i(\theta)$:

$$(3.11) \quad \alpha_i^{2-n}(\theta) = \frac{2-n}{\gamma u^2} \int_{\theta}^0 \frac{\exp(\tau/(\gamma + \beta\tau))}{1 + \tau/\alpha_i(\tau)} d\tau \quad (i = 0, 1, 2, \dots).$$

From the representation of the solution

$$(3.12) \quad a^{2-n}(\theta) = \frac{2-n}{\gamma u^2} \int_{\theta}^0 \frac{\exp(\tau/(\gamma + \beta\tau))}{1 + \tau/a(\tau)} d\tau$$

and inequalities (3.8), it follows that

$$(3.13) \quad \alpha_i(\theta) \leq \alpha_{i+1}(\theta) \leq a(\theta), \quad i = 0, 1, 2, \dots \quad (-1+h \leq \theta \leq 0).$$

Existence of the integral in (3.11) follows from the existence of the integral in (3.12) and the inequalities (3.8).

Using the representation (3.6) for the speed and the inequalities (3.13), we obtain

$$(3.14) \quad u^2 < \frac{2-n}{\gamma} \int_{-1+h}^0 \frac{\exp(\tau/(\gamma + \beta\tau))}{1 + \tau/\alpha_i(\tau)} d\tau \quad (i = 0, 1, 2, \dots).$$

Existence of the integral in (3.14) for all i obviously follows from existence of the integral for $i = 0$. For existence of the latter it is sufficient to require existence of the inequalities

$$(3.15) \quad \alpha_0(\theta) > -\theta \quad (0 \geq \theta \geq -1+h)$$

and

$$(3.16) \quad \lim_{\theta \rightarrow 0} (-\theta/\alpha_0(\theta)) < 1.$$

For $n > 1$ inequality (3.15) does not hold near zero. In case $n \leq 1$, which we consider in this section, this follows from the inequality $\alpha_0^2(\theta) > -\theta$, i.e.,

$$J_0 \equiv \frac{2-n}{\gamma u^2} \int_{\theta}^0 \frac{\exp(\tau/(\gamma + \beta\tau))}{1 + \tau} d\tau > -\theta \quad (-1 + h \leq \theta < 0).$$

It is easy to verify that $J_0''(\theta) < 0$ for $\gamma < h$. Since $J_0(0) = 0$ and $J_0(-1 + h) \rightarrow 1$ as $\gamma \rightarrow 0$ ($u^2 \rightarrow 2 - n$ as $\gamma \rightarrow 0$; see §1), it follows that inequality (3.15) is satisfied for γ sufficiently small. The value of the limit in (3.16) is equal to zero for $n < 1$ and to γu^2 for $n = 1$.

Let us denote the right-hand side of (3.14) by $\Phi_i(u^2)$. It is easy to see that for $u = u_i$ the functions a_{i+1} and α_i coincide; therefore, $\Phi_i(u_i^2) = F_{i+1}(u_i^2)$. Further, the functions $\Phi_i(u^2)$ are increasing, and, in the domain of definition, $\Phi_{i+1} < \Phi_i$. If we denote by \tilde{u}_i^2 the solution of the equation

$$(3.17) \quad u^2 = \Phi_i(u^2)$$

(more exactly, the smallest of the solutions), we then obtain a decreasing sequence of numbers \tilde{u}_i^2 , converging to the value of the speed. Solvability of equation (3.17) for $i > 0$ follows from its solvability for $i = 0$, the latter being true for γ sufficiently small, as will be seen later.

3.3. Asymptotics of the speed for $0 \leq n \leq 1$. The following inequality was proved above:

$$F_1(u^2) < u^2 < \Phi_0(u^2).$$

In this section we present the two leading terms in the asymptotic expansion of functions F_1 and Φ_0 as $\gamma \rightarrow 0$. It proves to be the case that these expansions coincide and, in this way, asymptotics of the speed are obtained. We note that for the functions F_i and Φ_{i-1} ($i > 1$) a larger number of terms of the expansion coincide, i.e., with their aid we can obtain the next terms of the asymptotics of the speed. The estimate (3.9) for $i = 0$ coincides with the estimate obtained in §1 by the minimax method, while function $a_1(\theta)$ coincides with the basic test function used there.

Function F_1 can be represented in the form $F_1 = F_{11} + F_{12}$, where

$$F_{11} = (2-n) \int_{\frac{-1+h}{\gamma}}^0 \exp \frac{\theta}{1 + \beta\theta} d\theta,$$

$$F_{12} = (2-n)\gamma \int_{\frac{-1+h}{\gamma}}^0 \frac{-\theta \exp(\theta/(1 + \beta\theta)) d\theta}{\gamma\theta + \left[1 - \frac{2-n}{u^2} \int_{\frac{-1+h}{\gamma}}^{\theta} \frac{\exp(\tau/(\gamma + \beta\tau))}{1 + \tau} d\tau\right]^{\frac{1}{2-n}}}.$$

In the expression for F_{11} we make the change of variables $x = \beta^{-1}(1 + \beta\theta)^{-1}$

under the integral sign and employ the asymptotic representation for the incomplete gamma-function:

$$\begin{aligned} & \int_{\frac{-1+h}{\gamma}}^0 \exp \frac{\theta}{1+\beta\theta} d\theta \\ &= \frac{1}{\beta^2} \exp(1/\beta) \left[-\frac{e^{-x}}{x} \Big|_{x=1/\beta}^{x=\frac{1/\beta}{1+\beta(-1+h)/\gamma}} - \Gamma(0, 1/\beta) + \Gamma\left(0, \frac{1/\beta}{1+\beta(-1+h)/\gamma}\right) \right] \\ &= 1 - 2\gamma + o(\gamma). \end{aligned}$$

We denote by I_{12} the integral in the expression for F_{12} . If in this integral we formally let $\gamma \rightarrow 0$, we obtain

$$(3.18) \quad \lim_{\gamma \rightarrow 0} I_{12} = \int_{-\infty}^0 \frac{-\theta \exp \theta d\theta}{(1 - \exp \theta)^{1/(2-n)}}$$

and the asymptotic representation for function F_1 has the form

$$F_1 = (2-n) \left[1 - 2\beta - \gamma \int_{-\infty}^0 \frac{-\theta \exp \theta d\theta}{(1 - \exp \theta)^{1/(2-n)}} + o(\gamma) \right].$$

To justify the passage to the limit in (3.18), we break up the integral I_{12} into two integrals with limits from $(-1+h)/\gamma$ to $-N$ and from $-N$ to 0, respectively. For sufficiently large N and small γ the first of these integrals is small, while in the second integral with constant limits we can pass to the limit as $\gamma \rightarrow 0$ according to Lebesgue's theorem.

Similarly, we may obtain an asymptotic representation of the function $\Phi_0(u^2)$. We note that if use is not made of the convergence $u^2 \rightarrow 2-n$ as $\gamma \rightarrow 0$, then, for fixed u^2 ,

$$\Phi_0(u^2) = (2-n) \left[1 - 2\beta + \gamma \left(\frac{u^2}{2-n} \right)^{\frac{1}{2-n}} \int_{-\infty}^0 \frac{-\theta \exp \theta d\theta}{(1 - \exp \theta)^{1/(2-n)}} + o(\gamma) \right].$$

From this follows, in particular, solvability of (3.17) for small γ , $i = 0$. Thus, for $0 \leq n \leq 1$ the two leading terms of the asymptotics of estimates from above and from below coincide; therefore, the asymptotics of the speed has the form

$$(3.19) \quad u^2 = (2-n) \left[1 - 2\beta + \gamma \int_0^\infty \frac{x \exp(-x) dx}{(1 - \exp(-x))^{1/(2-n)}} + o(\gamma) \right].$$

The coefficient of γ can be written in the form

$$\int_0^\infty \frac{x \exp(-x) dx}{(1 - \exp(-x))^{1/(2-n)}} = \frac{2-n}{1-n} \left[\Psi \left[\frac{3-2n}{2-n} \right] - \Psi(1) \right],$$

where

$$\Psi(z) = \Gamma'(z)/\Gamma(z),$$

$\Gamma(z)$ is the gamma-function, $\Psi(z)$ is the digamma-function.

The asymptotics of the speed (3.19) coincides for $0 \leq n \leq 1$ with the asymptotics, obtained in [Berm 2, Khu 2], through matching of asymptotic expansions.

3.4. Method of successive approximations for $1 < n \leq 2$. The initial approximation considered in the preceding section does not allow us to obtain asymptotics of the estimate from above for $n > 1$. Therefore we consider here another approximation. To this end, we consider the equation

$$(3.20) \quad \frac{db}{d\theta} = -\frac{1}{\gamma u^2} \frac{b^n}{b + \theta}.$$

Comparing equations (3.3) and (3.20), we see that if $b(\theta) = a(\theta)$, then $db/d\theta < da/d\theta$, i.e., the trajectories of equation (3.20) intersect the trajectories of equation (3.3) from above downwards. Therefore, the solution of equation (3.20), with the boundary condition $b(0) = 0$, for some $\theta = \theta_0$ becomes equal to one. As initial approximation we take the function $b_0(\theta)$, which coincides with the indicated solution when it is less than one, and is equal to one for $-1 + h \leq \theta \leq \theta_0$. Thus,

$$(3.21) \quad a(\theta) \leq b_0(\theta) \leq 1 \quad (-1 + h \leq \theta \leq 0),$$

where $a(\theta)$ is the solution of problem (3.3), (3.4). As before, we specify the successive approximations in the form

$$b_{i+1}^{2-n}(\theta) = 1 - \frac{2-n}{\gamma u^2} \int_{-1+h}^{\theta} \frac{\exp(\tau/(\gamma + \beta\tau))}{1 + \tau/b_i(\tau)} d\tau \quad (i = 0, 1, 2, \dots).$$

From inequality (3.21) we have the inequality

$$a(\theta) \leq b_i(\theta) \leq a_i(\theta), \quad i = 0, 1, 2, \dots \quad (-1 + h \leq \theta \leq 0)$$

and from it, in turn, we have convergence of the successive approximations $b_i(\theta)$ to the solution $a(\theta)$ and the inequalities

$$u^2 > \frac{2-n}{\gamma} \int_{-1+h}^0 \frac{\exp(\tau/(\gamma + \beta\tau))}{1 + \tau/b_i(\tau)} d\tau \quad (i = 0, 1, 2, \dots).$$

To obtain estimates of the speed from above, we need to specify yet another sequence of functions estimating the solution from below:

$$\beta_i^{2-n}(\theta) = \frac{2-n}{\gamma u^2} \int_{\theta}^0 \frac{\exp(\tau/(\gamma + \beta\tau))}{1 + \tau/b_i(\tau)} d\tau \quad (i = 0, 1, 2, \dots).$$

If

$$(3.22) \quad \beta_i(\theta) > -\theta \quad (-1 + h \leq \theta < 0),$$

then

$$(3.23) \quad u^2 < \frac{2-n}{\gamma} \int_{-1+h}^{\theta} \frac{\exp(\tau/(\gamma + \beta\tau))}{1 + \tau/\beta_i(\tau)} d\tau \quad (i = 0, 1, 2, \dots).$$

We note that (3.22) does not yet imply finiteness of the integral in (3.23). Inequality (3.23) will be used later for $i = 0$; therefore, we need to verify that it is satisfied in this case.

For $\theta \leq \theta_0$, $b_0(\theta) \equiv 1$, we may therefore prove inequality (3.22) the same way we proved inequality (3.15). Further, function β_0 satisfies the equation

$$(3.24) \quad \frac{d\beta_0}{d\theta} = -\frac{1}{\gamma u^2} \frac{\beta_0^{n-1} b_0 \exp(\theta/(\gamma + \beta\theta))}{b_0 + \theta}$$

with the boundary condition $\beta_0(0) = 0$. Therefore, validity of inequality (3.22) for $\theta_0 \leq \theta < 0$ will follow from the inequality

$$(3.25) \quad -\frac{1}{\gamma u^2} \frac{(-\theta)^{n-1} b_0 \exp(\theta/(\gamma + \beta\theta))}{b_0 + \theta} < -1,$$

which means that the trajectories of equation (3.24) intersect the line $\beta_0 = -\theta$ from above downwards. Introducing the notation

$$(3.26) \quad \begin{aligned} \varepsilon &= (\gamma\sigma m)^m / \gamma, & \psi_m(z) &= z^{1-m} E_m(z) \exp z, \\ m &= 1/(n-1), & z &= \gamma\sigma m [b_0(\theta)]^{-1/m}, \end{aligned}$$

where E_m is the integral exponential function,

$$E_m(z) = \int_1^\infty \frac{e^{-zt}}{t^m} dt,$$

we obtain, solving (3.20),

$$\theta/b_0(\theta) = -z E_m(z) \exp z,$$

and we write inequality (3.25) in the form

$$(3.27) \quad m[\psi_m(z)]^{1/m} \exp \frac{-\varepsilon\psi_m(z)}{1 - \beta\varepsilon\psi_m(z)} \geq 1 - z E_m(z) \exp z \quad (z > \gamma\sigma m).$$

Validity of (3.27) may be verified through simple calculations in which the inequalities

$$\frac{1}{z+m} \leq E_m(z) \exp z \quad (z \geq 0, \quad m > 1)$$

and

$$\psi_m(z) \leq -\theta_0/\gamma\varepsilon \quad (z > \gamma\sigma m)$$

are taken into account; these inequalities follow from properties of these special functions.

3.5. Asymptotics of the speed for $1 < n \leq 2$. As in §3.3, we obtain asymptotic representation of estimates from above and below.

Let J denote the right-hand side in the estimate (3.23) for $i = 0$; after simple manipulations, using the notation (3.26), we obtain

$$J = (2 - n) \left[\int_{\frac{-1+h}{\gamma}}^0 \exp \frac{\theta}{1 + \beta\theta} d\theta + J_1 + J_2 \right],$$

where

$$J_1 = -\gamma \int_{\frac{-1+h}{\gamma}}^{\theta_0/\gamma} \theta \exp \frac{\theta}{1 + \beta\theta} / \left\{ \gamma\theta + \left[\frac{2-n}{u^2} \left(\int_{\theta}^0 \exp \frac{\tau}{1 + \beta\tau} d\tau - \gamma \int_{\theta}^{\theta_0/\gamma} \left(\tau \exp \frac{\tau}{1 + \beta\tau} / (1 + \gamma\tau) \right) d\tau + \varepsilon \int_{\gamma u^2 m}^{\infty} \psi_m(z) \exp \frac{-\varepsilon\psi_m(z)}{1 - \beta\varepsilon\psi_m} dz \right) \right]^{\frac{1}{2-n}} \right\} d\theta$$

(3.28)

$$J_2 = -\varepsilon \int_{\theta_0/\gamma\varepsilon}^0 \tau \exp \frac{\varepsilon\tau}{1 + \beta\varepsilon\tau} / \left\{ \tau + (m-1)^{1/(m-1)} \left[\frac{1}{\varepsilon} \int_{\varepsilon\tau}^0 \exp \frac{\tau_1}{1 + \beta\tau_1} d\tau_1 + \int_{z_0(\tau)}^{\infty} \psi_m(z) \exp \frac{-\varepsilon\psi_m(z)}{1 - \beta\varepsilon\psi_m} dz \right]^{\frac{m}{m-1}} \right\} d\tau.$$

(3.29)

Thus, the problem of determining asymptotics of the estimate from above is reduced to determining asymptotics of integrals J_1 and J_2 .

It is not difficult to show that

$$J_1 = -\gamma \int_{-\infty}^{-1} \frac{\theta \exp \theta d\theta}{(1 - \exp \theta)^{1/(2-n)}} + o(\gamma),$$

(3.30)

$$J_2 = -\gamma \int_{-1}^0 \frac{\theta \exp \theta d\theta}{(1 - \exp \theta)^{1/(2-n)}} + o(\gamma) \quad \left(1 < n < \frac{3}{2} \right),$$

(3.31)

$$J_2 = -\varepsilon \int_{-\infty}^0 \frac{\tau d\tau}{\tau + (m-1)^{m/(m-1)} \left[-\tau + \int_{z_0(\tau)}^{\infty} \psi_m(z) dz \right]^{\frac{m}{m-1}}} + o(\varepsilon)$$

$$= \varepsilon + \int_0^{\infty} \psi_m(z) dz + o(\varepsilon) = \varepsilon \frac{\Gamma(2-m)}{m-1} + o(\varepsilon) \quad \left(\frac{3}{2} < n < 2 \right).$$

(3.32)

In (3.30), (3.31) we have taken into account that $u^2 \rightarrow 2 - n$ as $\gamma \rightarrow 0$, which has no influence on the form of the leading terms. In (3.32) a change of this kind, generally

speaking, cannot be made since it leads to a nonuniformity of the asymptotics. If, however, we have nonuniform asymptotics in mind, then, by virtue of (3.30)–(3.32), for an estimate from above it has the form

$$(3.33) \quad \bar{u}^2 = (2 - n) \left[1 - 2\beta + \gamma \int_0^\infty \frac{x \exp(-x) dx}{(1 - \exp(-x))^{1/(2-n)}} + o(\gamma) \right] \quad \left(1 < n < \frac{3}{2} \right),$$

$$(3.34) \quad \bar{u}^2 = (2 - n) \left[1 + \gamma^{\frac{2-n}{n-1}} \left(\frac{2-n}{n-1} \right)^{\frac{2-n}{n-1}} \Gamma \left(\frac{2n-3}{n-1} \right) + o \left(\gamma^{\frac{2-n}{n-1}} \right) \right] \quad \left(\frac{3}{2} < n < 2 \right).$$

The expressions (3.33), (3.34) cannot be used for $n = 3/2$ since the value of discarded terms depends on n and increases as $n \rightarrow 3/2$. Asymptotics of the integrals (3.28), (3.29) for $n = 3/2$ yields

$$(3.35) \quad \bar{u}^2 = \frac{1}{2} (1 - \gamma \ln \gamma + o(\gamma)) \quad \left(n = \frac{3}{2} \right).$$

Asymptotics of the estimate from below is obtained in a similar way, coincides with (3.33)–(3.35), and coincides with that obtained in [Berm 2, II 4].

Being limited to the leading term in the expansion of the integrals J_1 and J_2 in powers of γ , we cannot, as is evident from the expressions given above, obtain a general representation for asymptotics of the speed for $1 < n < 2$. For an estimate of the speed from above, the general representation mentioned has the form

$$(3.36) \quad \bar{u}^2 = (2 - n) \left[1 - 2\beta - \frac{\varepsilon_0 \psi_{m-2}(\gamma(m-1))}{(m-2)(m-1)} + \frac{\varepsilon_0}{(m-2)(m-1)^{1/(m-1)}} + \frac{1}{(m-1)^{1/(m-1)}} \sum_{r=1}^\infty \frac{\varepsilon_0^{1/(m-1)} - \varepsilon_0^r}{r(r-1/(m-1))} + O \left(\left(\frac{\varepsilon_0 - \gamma}{2-m} \right)^2 \right) \right],$$

where $\varepsilon_0 = \gamma^{m-1}(m-1)^m$. We note that the asymptotics (3.36) is written out to within the square terms; this leads to the appearance of additional terms in the expansion in comparison with (3.33)–(3.35). In this regard, it cannot be essentially simplified for all n , $1 < n \leq 2$.

A similar representation can be written down for asymptotics of the estimate from below; however, only two of the leading terms in their expansions agree.

In conclusion, we turn our attention to the problem concerning uniform asymptotics of the speed as $n \rightarrow 2$. As already pointed out, the method of successive approximations makes it possible to obtain estimates of the speed from above and from below in terms of functions depending, in turn, on the speed. Agreement of the two leading terms in the asymptotics of these functions allows us to write an asymptotic equation for the speed ($3/2 < n < 2$):

$$(3.37) \quad u^2 = (2 - n) \left[1 + \left(\frac{\gamma u^2}{n-1} \right)^{\frac{2-n}{n-1}} \Gamma \left(\frac{2n-3}{n-1} \right) \frac{u^2}{2-n} + o \left(\gamma^{\frac{2-n}{n-1}} u^{\frac{2}{n-1}} \right) \right].$$

Analysis of the integrals J_1 and J_2 shows that the terms discarded remain bounded as $n \rightarrow 2$, which allows for a passage to the limit. As a result, for $n = 2$ we obtain

$$u^2 \ln \frac{1}{\gamma u^2} \sim 1,$$

whence

$$u^2 \sim \frac{1}{\ln(1/\gamma)},$$

which agrees with the leading term in the asymptotics obtained in [Berm 2]. Neglecting the higher order terms in (3.37), we obtain

$$u^2 = \frac{2-n}{1 - \left(\frac{\gamma u^2}{n-1}\right)^{\frac{2-n}{n-1}} \Gamma\left(\frac{2n-3}{n-1}\right)}.$$

This transcendent equation for u^2 can be solved by the method of successive approximations, enabling us to write

$$(3.38) \quad u^2 \sim \frac{2-n}{1 - \gamma^{\frac{2-n}{n-1}} \left(\frac{2-n}{n-1}\right)^{\frac{2-n}{n-1}} \Gamma\left(\frac{2n-3}{n-1}\right) \frac{1}{(1-\gamma^{2-n})^{2-n}}}.$$

Expression (3.38) gives uniform asymptotics as $n \rightarrow 2$ and two of the leading terms of a nonuniform asymptotics for $3/2 < n < 2$.

Bibliographic commentaries

A variational method for determining wavespeed for a scalar equation was employed in [Ros 1, 2]. In [Had 2], also for a scalar equation, a minimax representation of the speed was obtained, and in [Vol 3] it was used for the analysis of waves. For a system of two equations describing propagation of a combustion wave in a condensed medium, a minimax representation of the speed was obtained in [Vol 38] and used in [Vol 34, 35, 40] to obtain estimates of the speed. A minimax representation was obtained in [Vol 7, 24–26, 41] for monotone systems describing combustion of gases in the case of equality of transport coefficients.

Asymptotics of the speed of a combustion wave in a condensed medium by the method of matched asymptotic expansions was studied in [Berm 2, Gal 1, Il 1, 4, Khu 2, Zel 5], and by the method of successive approximations in [Vol 28]. The method of successive approximations for combustion problems was also considered in [Wil 1].

Estimates of the speed from below for a model of gasless combustion were obtained in [Vag 1]. For a scalar equation estimates of the speed appear in [Ald 18, Vol 9, Wil 1, Zel 5]. For certain sources of a particular type the speed of a wave can be found explicitly ([Ald 18, Kha 2, Mas 1]).

There is also a number of papers in which approximate formulas were obtained for the speed (see the supplement to Part III).

SUPPLEMENT

Asymptotic and Approximate Analytical Methods in Combustion Problems

In Chapters 8–10 methods developed earlier were applied to the study of waves in chemical kinetics and combustion. Along with strict mathematical methods in combustion problems, approximate analytical methods are often applied, which make it possible to determine quantitative characteristics of waves for various models. These approaches can, in a number of cases, be justified by means of asymptotic methods, which may also be applied independently, although, as a rule, rather formally. Therefore, approximate analytical and asymptotic investigations are often accompanied by a numerical analysis of the models in question.

We present here a survey of the literature, which reflects the contemporary state of the problem. As a rule, we confine the discussion to models of the combustion of premixed reactants, without taking hydrodynamics into account. In a number of cases the notation used in individual papers has been changed. In our presentation we follow [Vol 20].

§1. Narrow reaction zone method. Speed of a stationary combustion wave

As has already been noted in the Introduction, combustion processes are characterized by the fact that the basic chemical transformation takes place over a narrow temperature interval close to the maximum temperature. This has enabled Zel'dovich and Frank-Kamenetskiĭ [Zel 2, 3, Fran 1] to propose the infinitely-narrow reaction zone method in which it is assumed that the reaction zone is concentrated at a point, and, outside of this reaction zone, the nonlinear source is set equal to zero. This makes it possible to replace nonlinear differential equations by linear equations and algebraic matching conditions across the reaction zone. With such an approach, the solution is continuous, but not smooth: its derivative undergoes a discontinuity in the reaction zone.

If the width of the reaction zone is small but finite, the solution can be sought in the form of an expansion in a small parameter connected with the width of the reaction zone. In this case the infinitely narrow reaction zone method yields a zero term in the expansion.

The narrow reaction zone method and various modifications of it are widely applied in various problems of combustion and they make it possible to determine approximately the speed of a wave, its structure, and stability. In using the method for new models the possibility of its application must be based on physical considerations or established mathematically, while the accuracy is estimated in some manner, for example, using a selective comparison with the results of a

numerical analysis.

Later in this section we consider some problems connected with the stationary propagation of a planar flame front through a pre-mixed combustible mixture in the case of a single-stage reaction with kinetics $\varphi(\alpha)$ and an Arrhenius temperature dependence in the reaction rate. In coordinates connected with the wave front the stationary system of equations describing the indicated process has the form

$$(S.1) \quad \varkappa \frac{d^2 T}{dx^2} - u \frac{dT}{dx} + q\varphi(a)F(T) = 0,$$

$$(S.2) \quad D \frac{d^2 a}{dx^2} - u \frac{da}{dx} - \varphi(a)F(T) = 0.$$

In the laboratory system of coordinates the wave propagates from right to left with speed u ; boundary conditions in the initial reactants ($x = -\infty$) and combustion products ($x = +\infty$) have the form

$$(S.3) \quad x = -\infty: T = T_i, \quad a = 1; \quad x = +\infty: \frac{dT}{dx} = 0, \quad a = 0.$$

Here T is the temperature of the combustible mixture, a is the concentration of the initial reactant, x is a spatial coordinate, \varkappa and D are the coefficients of thermal diffusivity and diffusion, respectively, q is the heat release of the reaction, $\varphi(a)$ is the kinetic function,

$$F(T) = k_0 \exp(-E/RT),$$

E is the activation energy, R is the gas constant, k_0 is a pre-exponential factor, and T_i is the initial temperature.

The thermal diffusion model described in connection with gas combustion assumes density of the gas to be constant and an absence of gasdynamic effects associated with this. The problem consists in clarifying the structure of a combustion wave and in obtaining the speed u . Since the appearance of the papers by Zel'dovich and Frank-Kamenetskii [**Zel 2, 3, Fran 1**], this formulation of the problem has been the object of numerous investigations. Results of studies relating, mainly, to the combustion of gases have appeared, in sufficient detail, for the simplest kinetic functions $\varphi(a)$ in the monograph of Zel'dovich, Barenblatt, et al. [**Zel 5**]. We turn our attention to some papers on the theory of waves of gasless combustion ($D = 0$).

In the case of gasless combustion system (S.1)–(S.3) has a first integral

$$(S.4) \quad \frac{\varkappa}{u} \frac{dT}{dx} = T - T_b + qa, \quad T_b = T_i + qa,$$

and, upon going over in (S.2), (S.4) to the independent variable T , we obtain the equation

$$(S.5) \quad \frac{da}{dT} = - \frac{\varkappa}{u^2} \frac{\varphi(a)F(T)}{T - T_b + qa}.$$

In dimensionless variables we may write (S.5) as

$$(S.6) \quad \frac{da}{d\theta} = - \frac{1}{\gamma v^2} \frac{\varphi(a) \exp(\theta/(\gamma + \beta\theta))}{a + \theta}$$

with the boundary conditions

$$(S.7) \quad \theta = -1, \quad a = 1; \quad \theta = 0, \quad a = 0.$$

Here θ is the dimensionless temperature, $\theta = (T - T_b)/(T_b - T_i)$,

$$\gamma = \frac{RT_b^2}{E(T_b - T_i)}, \quad \beta = \frac{RT_b}{E},$$

v is the dimensionless speed of the front; $u^2 = \gamma \varkappa v^2 F(T_b)$. In these dimensionless variables the initial temperature is equal to -1 ; the burning temperature is equal to zero. (We shall not consider here problems connected with nonvanishing of the source at the initial temperature, in that we assume that the procedure of a “cut-off of the source” was applied, as has been studied in detail in the paper by Aldushin, Lugovoi, et al. [**Ald 10**].)

Problem (S.6), (S.7) for a first order reaction ($\varphi(a) = a$) was solved by Novozhilov [**Nov 1**]. The presentations in [**Zel 2, 3, Fran 1**], relating to narrowness of the reaction zone and its localization at maximum temperatures, make it possible, in obtaining the speed, to put $\theta = 0$ in the denominator of the right-hand side of (S.6) and to solve the resulting equation by separating the variables. This same approach can be used for the power-law kinetics $\varphi(a) = a^n$ with reactions of small order ($n \leq 3/2$) and other kinetic laws with weak concentrational dependence of the reaction rate and gives

$$u^2 \approx \left(\int_0^1 \frac{ada}{\varphi(a)} \right)^{-1} \varkappa \frac{RT_b}{Eq} k_0 e^{-E/RT_b}.$$

Fundamental new results concerning the structure and speed of a combustion wave were obtained in the papers of Aldushin, Merzhanov, Khaikin, et al. [**Ald 4, 5, 7**]. In these papers the authors considered kinetic laws typical for heterogeneous combustion that express a decrease in the rate of heat liberation on account of a product layer increasing with reactive diffusion,

$$\varphi(a) = \frac{1}{(1-a)^n} e^{-m(1-a)}.$$

It has been shown in the case of strong kinetic deceleration of the reaction rate ($m \gg 1$ or $n \gg 1$) that wide reaction zones and the presence of a burnout zone are typical. The zone of propagation responsible for the speed of a wave is disposed at temperatures essentially less than the adiabatic temperature of combustion. Expressions are obtained for the speed of the front.

In connection with the consideration of problems of heterogeneous combustion, we refer to the paper of Aldushin and Khaikin [**Ald 8**], in which, using the simplest model of a layered sample, the authors display the thermal homogeneity of a combustion wave.

For an equation of the type (S.6), with kinetics $\varphi(a)$ of the form

$$\varphi(a) = \frac{a^{7/3}}{(1-a)^2(1-a^{1/3})},$$

Booth [**Bot 1**] has studied propagation of the front of a reaction in an ($Fe - BaO_2$)-mixture under the assumption of a spherical geometry of reactant particles. In his paper Booth's concern was to obtain the speed of the front, for which he made use of the following method, applied earlier in another situation by Boys and

Corner [**Boy 1**]. In the kinetic function $\varphi(a)$ a factor $\varphi_0(a)$ is identified, which determines behavior of the kinetics as $a \rightarrow 0$: $\varphi = \varphi_0 \cdot \varphi_1$. For the case in question,

$$\varphi_0(a) = a^{7/3}, \quad \varphi_1(a) = \frac{1}{(1-a)^2(1-a^{1/3})}.$$

Next, the equation

$$(S.8) \quad \frac{da}{d\theta} = -\frac{1}{\gamma v^2} \frac{\varphi_0(a)}{a + \theta}$$

is solved and the solution

$$\theta_*(a) = -\exp\left(\frac{3}{4}\gamma v^2 a^{-4/3}\right) \int_0^a \gamma v^2 \xi^{-4/3} \exp\left(-\frac{3}{4}\gamma v^2 \xi^{-4/3}\right) d\xi$$

is substituted into the denominator of the right-hand side of (S.6):

$$(S.9) \quad \frac{da}{d\theta} = -\frac{1}{\gamma v^2} \frac{\varphi(a) \exp(\theta/(\gamma + \beta\theta))}{a + \theta_*(a)}.$$

The variables in (S.9) can be separated, and as a result of an integration, an equation is obtained for the determination of v^2 :

$$(S.10) \quad \gamma v^2 \int_0^1 \frac{a + \theta_*(a)}{\varphi(a)} da = \int_{-1}^0 \exp \frac{\theta}{\gamma + \beta\theta} d\theta.$$

We note that the quantity v^2 appears in (S.10) not only as a factor on the left-hand side of the equation, but also in the function $\theta_*(a)$, so that the equation turns out to be rather involved. In [**Bot 1**] it was solved numerically. Actually, equation (S.10) can be solved approximately analytically, using the fact that γ is small.

Let us consider the possibilities of the method described above. This method is to be applied for the case in which the order of the reaction satisfies $n \geq 3/2$ but not large (more exactly, when $\varphi_0 = a^n$, $n \geq 3/2$). For $n \leq 3/2$ this method leads to the same results as the method of Novozhilov [**Nov 1**], but is more involved.

In [**Har 1**] Hardt and Phung also study propagation of a combustion front in a heterogeneous system. A model involving parallel alternating layers of two metals is considered, the layers being disposed perpendicular to the direction of propagation (see also [**Str 1**, **Fir 1**]). Taking into account deceleration of the rate of the reaction by the growth of a product layer we get, according to the parabolic law, an equation of the type (S.6) with the kinetics $\varphi(a) = (1-a)^{-1}$. The problem was solved numerically and approximately analytically. The problem concerning structure of a wave and speed of a front was also solved in [**Ald 4**, **5**] in a more general setting, where, in the case of the parabolic law of oxidation, the result obtained was $v^2 = 6$, or, in dimensional form,

$$(S.11) \quad u^2 \approx 6 \frac{RT_b}{Eq} k_0 \exp\left(-\frac{E}{RT_b}\right).$$

We note that the approximate formula (S.11) is an estimate of the square of the speed from below, and its accuracy, for realistic values of the parameters, amounts to several percent. This is a strict mathematical result, which can be obtained by an application of the minimax method, making it possible to obtain precise estimates of the speed from above and from below (see Chapter 10).

In a paper by Margolis and Green [**Mar 3**] a heterogeneous condensed combustible mixture consists of pre-mixed particles of metal and a metal-gas combination (for example, an oxide). Reduction of the metal from the oxide must precede reaction between the metals. In the paper a numerical analysis of a model problem is given and a detailed study is made of the behavior of the solution of a differential equation in a neighborhood of a singular point.

Mathematical studies and results relating to the asymptotics of a stationary combustion wave, including that in a condensed medium, were presented in [**II 4**] and [**Khu 2**].

The paper by Puszynski, Degreve, and Hlavacek [**Pus 1**] is of a survey nature. In it results are presented of an approximate analytical and numerical study of the propagation of a combustion front in a condensed medium for a first order reaction.

§2. Stability of a stationary combustion wave

Various qualitative concepts dealing with the possibility of an instability of a planar flame front were discussed for the first time in the papers of Zel'dovich [**Zel 3**] and Lewis and von Elbe [**Lew 1**].

A mathematical analysis of stability in the framework of a thermal-diffusion formulation,

$$(S.12) \quad \begin{aligned} \frac{\partial T}{\partial t} &= \varkappa \left(\frac{\partial^2 T}{\partial x^2} + \frac{\partial^2 T}{\partial y^2} \right) - u \frac{\partial T}{\partial x} + q\varphi(a)F(T), \\ \frac{\partial a}{\partial t} &= D \left(\frac{\partial^2 a}{\partial x^2} + \frac{\partial^2 a}{\partial y^2} \right) - u \frac{\partial a}{\partial x} - \varphi(a)F(T), \end{aligned}$$

where y is a coordinate perpendicular to the direction of wave propagation, was carried out in [**Baren 3**] by Barenblatt, Zel'dovich, and Istratov. The solution of system (S.12) was represented as the sum of a stationary solution and a small perturbation

$$(S.13) \quad \begin{aligned} T(t, x, y) &= T_{\text{st}}(x) + \tilde{T}(x) \exp(\omega t +iky), \\ a(t, x, y) &= a_{\text{st}}(x) + \tilde{a}(x) \exp(\omega t +iky), \end{aligned}$$

and a perturbation was also imposed on the position of the reaction zone. Here ω is the perturbation frequency, k is the wave number. Substitution of (S.13) into (S.12) and the replacement of the distributed reaction zone by the combustion surface, on which solutions, obtained in the zones of heating and combustion products, must be matched, lead to the dispersion relation

$$(S.14) \quad \begin{aligned} Z &= \frac{\Gamma(\Gamma_L - Le)}{1 - \Gamma - (Le - \Gamma_L)}, \\ \Gamma_L &= ((Le)^2 + 4\Omega Le + 4s^2)^{1/2}, \quad \Gamma = \sqrt{1 + 4\Omega + 4s^2}, \end{aligned}$$

where $Z = \varkappa F(T_b)/u^2$ is the temperature coefficient of the wave speed, $s = \varkappa k/u$ is a dimensionless wave number, $\Omega = \varkappa \omega/u^2$ is the dimensionless perturbation frequency, and $Le = \varkappa/D$ is the Lewis number.

The dispersion relation allows us to make conclusions concerning the stability of a combustion wave. If all eigenvalues Ω , obtained from (S.14) as functions of the parameters of the problem, have negative real parts, then the stationary wave is stable. If at least one Ω has a positive real part, the stationary wave is unstable. The

case $\text{Re } \Omega = 0$ corresponds to the boundary of stability providing that the remaining eigenvalues lie in the left half of the complex plane. Loss of stability of a planar wave occurs either on account of the fact that a pair of complex conjugate eigenvalues pass from the left half-plane into the right half-plane through the imaginary axis ($D < \varkappa$), which leads to an oscillatory instability, or if an eigenvalue passes through 0 ($D > \varkappa$). The latter can take place only in the multi-dimensional case and leads to the appearance of stationary curved fronts.

The dispersion relation (S.14) was studied in [Baren 3] for the case of long-wave perturbations ($s \ll 1$). An analysis of the dispersion relation (S.14) for the case of arbitrary Lewis numbers and lengths of perturbation waves is contained in papers of Grishin and Zelenskiĭ [Gris 1, 2] and Sivashinskiĭ [Siv 1, 4]. We refer also to the paper of Aldushin and Kasparyan [Ald 11], which differs from [Baren 3] by a matching condition for solutions in the reaction zone, and from [Ald 9] in which a model step source is considered. A numerical analysis of the linearized problem on eigenvalues is given in [Boris 1].

We turn our attention in more detail to the case $D = 0$. The dispersion relation (S.14) then has the form

$$4\Omega^3 + \Omega^2(1 + 4Z - Z^2 + 4s^2) + \Omega Z(1 + 4s^2) + s^2 Z^2 = 0.$$

The boundary of oscillatory instability with respect to perturbations with wave number s is specified by the equation

$$Z = \left[2 + 6s^2 + \sqrt{4(1 + 3s^2)^2 + (1 + 4s^2)^3} \right] / (1 + 4s^2).$$

The frequency on the stability boundary is pure imaginary, $\Omega = i\psi$,

$$\psi^2 = \frac{1}{4} \left[2 + 6s^2 + \sqrt{4(1 + 3s^2)^2 + (1 + 4s^2)^3} \right].$$

The curve $Z(s^2)$ has a minimum for $s = 1/2$, $Z = 4$. Loss of stability with respect to one-dimensional perturbations ($s = 0$) appears for the larger value $Z = 2 + \sqrt{5}$.

These results were obtained in papers by Maksimov and Shkadinskiĭ [Mak 2], Makhviladze and Novozhilov [Makh 1, 2], Khaikin and Shkadinskiĭ [Kha 8], and Matkowskiĭ and Sivashinskiĭ [Mat 1]. A detailed numerical analysis of the nonstationary problem was carried out in a paper by Shkadinskiĭ, Khaikin, and Merzhanov [Shk 3], and the case of nonstationary propagation of a combustion front for strong kinetic dependence of the reaction rate was studied numerically by Aldushin et al. in [Ald 6].

§3. Nonadiabatic combustion

For the combustion of gases, Zel'dovich [Zel 1] has obtained what has become a classical result concerning the limits of combustion in the presence of heat loss. As shown in the paper by Maksimov, Merzhanov, and Shkiro [Mak 1], this result carries over without difficulty to gasless systems in the case of narrow reaction zones. The effect of heat loss on the propagation of a combustion wave for gasless systems with strong kinetic dependence of the reaction rate was investigated in [Ald 6] and [Shk 2] by Aldushin, Merzhanov, Khaikin, Shkadinskiĭ, et al., and, as shown in these papers, leads to the incompleteness of the conversion into final products and an increase in the probability of extinction during self-oscillating propagation in combustion with narrow zones of reactions.

The stability of a nonadiabatic combustion wave, propagating in a condensed medium, was the subject of study in papers by Makhviladze and Novozhilov [Makh 1] and Khaikin and Shkadinskiĭ [Kha 8]. This problem was solved for arbitrary Lewis numbers by Agranat and co-authors in [Agranat 1] and by Aldushin and Kasparyan in [Ald 12].

The effect of heat loss on the propagation of a stationary wave of combustion was also investigated in papers by Spalding [Spa 1], Adler [Adl 1], Buckmaster [Buc 1], Joulin and Clavin [Jou 2], and by Puszynski and co-authors in [Pus 1] (see also [Alek 1, 2, Dvo 1, Fir 2, Kape 1, Ryb 1–3, Str 4, Thi 1]). The method of matched asymptotic expansions was applied in the solution of the problem in [Buc 1] and [Jou 2]; in [Jou 2] it was shown that there is a possibility of incomplete conversion during the course of reactions of order higher than the first order.

Investigations of the effect of heat loss on the stability of a combustion wave are of great interest.

In a paper by Joulin and Clavin [Jou 3] consideration is given to the traditional formulation in which the reflecting heat loss term $-\alpha_*(T - T_i)$ is included in the heat conduction equation (S.12). Here, the boundary condition in the product zone is changed at $x = \infty$: $T = T_i$, $a = 0$. The problem was solved by the method of matched asymptotic expansions. In this paper the dispersion relation was obtained for the case of a Lewis number close to one, $Le = 1 + \gamma l_0$, and it has the form

$$(1 - \Gamma) \left\{ \frac{\alpha}{2} (\Gamma + 1) - \Gamma^2 \right\} = \frac{1}{2} l_0 (1 - \Gamma + 2\Omega).$$

The parameter α appearing in the equation is connected with heat losses:

$$(S.15) \quad \alpha = \frac{2\kappa\alpha_*}{\gamma u^2}.$$

In the study of the stationary problem the leading term with respect to γ obtained was

$$(S.16) \quad \alpha = -2 \ln \frac{u}{u_{\text{ad}}},$$

where u_{ad} is the propagation speed of an adiabatic combustion wave. Comparing (S.15) and (S.16), we obtain

$$\frac{2\kappa}{\gamma u_{\text{ad}}^2} \alpha_* = - \left(\frac{u}{u_{\text{ad}}} \right)^2 \ln \left(\frac{u}{u_{\text{ad}}} \right)^2.$$

A consequence of this relation is the result, given in [Zel 1], concerning the limits of combustion and the presence of two propagation speeds when

$$\alpha_* < \frac{u_{\text{ad}}^2}{2\kappa} \gamma e^{-1} :$$

a fast speed corresponding to $0 \leq \alpha < 1$ and coinciding with u_{ad} for $\alpha = 0$, and a slow speed corresponding to $\alpha > 1$.

It is readily found from an analysis of the dispersion relation that the slow wave is always unstable with respect to one-dimensional perturbations. For a fast wave, the stability boundaries obtained have the form $l_0 = -2(1 - \alpha)$, the boundary of cellular instability with respect to two-dimensional perturbations; $l_0 = 4 - 2\alpha + 4\sqrt{3 - 2\alpha}$ is the boundary of oscillatory instability with respect to one-dimensional

perturbations. The boundary of oscillatory instability $\widehat{l}_0(\alpha)$ with respect to two-dimensional perturbations is obtained numerically. \widehat{l}_0 varies monotonically from the value ≈ 10.5 for $\alpha = 0$ to the value 3.6 for $\alpha = 1$. With a change of parameters, the two-dimensional instability occurs earlier than the one-dimensional instability, and this difference between the stability boundaries increases as the combustion limit is approached.

The paper by Sohrab and Chao [Soh 1] is close, in its formulation and method of investigation, to [Jou 3]. The problem of concern here is how heat losses, taken separately in the combustion products and in a fresh mixture, affect the stability of a wave. Here the term $-\alpha_*(T - T_i)$ in the heat combustion equation, which is associated with heat losses, is neglected either before or after the zone of reaction. Without going into the details of the study, we supply the dispersion relations:

$$(1 - \Gamma) \left(\frac{\alpha}{2} - \Gamma^2 \right) = \frac{1}{2} l_0 (1 - \Gamma + 2\Omega)$$

in the case of heat loss before the reaction zone, and

$$(1 - \Gamma) \left(\frac{\alpha}{2} \Gamma - \Gamma^2 \right) = \frac{1}{2} l_0 (1 - \Gamma + 2\Omega)$$

in the case of heat loss in the products. The main qualitative conclusion is that the propagation of combustion waves turns out to be less stable for heat loss in the products than in the case of two-sided heat loss, which, in turn, is less stable than in the case of heat loss before the reaction zone.

§4. Stage combustion

The existing papers on stage combustion can be divided into three groups. The first group examines the propagation of combustion waves in the course of which there are the sequential reactions

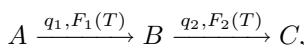

wherein the initial reacting substance A is transformed into the intermediate product B , after which final product C is formed; the second group involves the independent reactions



in which the initial mixture contains the mutually nonreacting substances A and C , and the interaction of the stages is effected through thermal factors; the third group deals with parallel (competing) reactions



in which transformation of the initial substance A into the final products can take place in two ways, through the formation of different intermediate products B and C , the transformation of which into the final products is retarded and shows no effect on the speed of propagation of the combustion wave. We denote by q_1 and q_2 the adiabatic heating in the reactions,

$$F_i(T) = k_i \exp \left(- \frac{E_i}{RT} \right),$$

E_i is the activation energy, k_i are pre-exponential factors.

We turn our attention briefly to papers, known to us, concerning each of the three reaction schemes presented above.

4.1. Sequential reactions. A detailed study of the propagation of the front of a two-stage chemical reaction was carried out for the first time in a paper by Khaikin, Filonenko, and Khudyaev [**Kha 3**]. They proposed a classification of modes and derived conditions under which they may be realized. The terminology, including control, coalescence, and separation regimes, was introduced afterwards in [**Mer 6**]. The classification of regimes was developed on the basis of a comparison of the speeds of a single-stage process which, from our point of view, expresses the physical essence of the problem better than a comparison of thermal dependences of reaction rates, carried out in subsequent papers. We turn our attention briefly to the results presented in [**Kha 3**]. Let $u_1(T_b)$ and $u_2(T_b)$ denote propagation rates of a single-stage process at the burning temperature T_b , and let $u_1(T_a)$ be the speed of propagation of the front of the first reaction in the absence of the second at temperature $T_a = T_i + q_1$. Then, with satisfaction of the inequalities

$$u_1(T_b) > u_2(T_b) > u_1(T_a)$$

the control mode is in effect, wherein the speed $u = u_2(T_b)$ of a two-stage wave and the distance between zones is such that heat from the zone of the second reaction, supplied to the zone of the first reaction, ensures uniform propagation of the wave. If $u_1(T_b) < u_2(T_b)$, then the coalescence regime is in effect, $u \approx u_1(T_b)$. For $u_1(T_a) > u_2(T_b)$ we have a separation regime, $u \approx u_1(T_a)$, and the zone of the second reaction propagates in a self-ignition combustion mode. The numerical calculations carried out in [**Kha 3**] show that regions where the parameters change, corresponding to a change of regimes, are narrow; this furnishes a basis for selecting, as the speed of the two-stage wave, the corresponding single-stage speed.

A study of the stability of a two-stage combustion wave with two narrow spatially-separated reaction zones was carried out for the case of a condensed medium in a paper by Vol'pert and Krishenik [**Vol 37**]. We mention also a paper by Merzhanov, Rumanov, and Khaikin on a many-zone combustion of condensed systems [**Mer 6**]; the papers of Nekrasov and Timokhin [**Nek 1, 2**] and the paper of Borovikov, Burovoi, and Goldschleger [**Borov 1**] on the stationary propagation of a two-stage combustion wave with an endothermic stage; and, finally, the paper of Vol'pert and Krishenik [**Vol 36**] on the stability of a two-stage wave with a nonactivated endothermic stage.

In [**Kor 1**] Korman, by introducing an ignition temperature and replacing the Arrhenius temperature dependence by a step-function, obtained an approximate analytical solution of the problem. He showed that if the ratio of the rate of the first reaction to the second is less than some critical value, then the combustion wave has a two-zone structure. As this critical value is attained, the distance between zones becomes infinite and the influence of the second front on the speed of the wave vanishes. In this paper numerical calculations of the structure of the front are also carried out.

In [**Kapi 1**] Kapila and Ludford generalized results of Berman and Ryazan-tsev [**Berm 1**]. They pointed out the restrictive character of the proposition in [**Berm 1**] concerning identical orders of pre-exponential factors and they rid themselves of this condition. The investigation, as is also the case in [**Berm 1**], is conducted by the method of matched asymptotic expansions. It is assumed that

the Lewis number of both stages is equal to one. As was the case in [Berm 1], the existence of three different modes was proved. If the condition

$$\frac{F_2(T_b)}{F_1(T_b)} \gg 1$$

is satisfied, then the intermediate substances are consumed as soon as they are formed and the speed of propagation of the wave is determined by the rate of the first reaction at the temperature $T_b = T_i + q_1 + q_2$ (coalescence regime). If the indicated ratio is less than one, two cases are possible. We introduce temperature T_{cr} such that

$$F_2(T_b) = F_1(T_{cr}).$$

If $T_{cr} < T_a$, the first reaction then propagates, with no essential influence from the side of the second reaction, which follows behind the first (separation regime). In case $T_{cr} > T_a$, the combustion wave has a two-zone structure, the distance between zones of the order of a heated layer of the second reaction; the wavespeed is determined by the rate of the second reaction at temperature T_b . The study of a transition mode between the regimes of control and full coalescence presents certain analytical difficulties, and, in the present paper, is developed only in the case of strongly different activation energies of the stages.

In [Jou 1] Joulin and Clavin investigate a mode which is intermediate between control and full coalescence regimes. They considered the case of activation energies of the stages, close in magnitude, but assumed thermal effect of the first stage equal to zero. The same problem was considered by Margolis and Matkowskii [Mar 5] without assuming $q_1 = 0$, but with a simplifying additional relation between parameters of the problem. Using the method of matched asymptotic expansions, the authors obtain the distance between points of completion of the reactions and the wavespeed, as functions of the parameters of the problem. In [Mar 6] Margolis and Matkowskii are concerned with an analysis of the stability of propagation of a combustion wave, described by the model of [Mar 5], with the additional condition of proximity to one of both Lewis numbers. First, an analysis of the problem is carried out by the method of matched asymptotic expansions, and, based on this analysis, a simplified model of the process is deduced, in which the Arrhenius heat source is replaced by a δ -function of the spatial variable with a corresponding weight factor. Next, a linear and a nonlinear stability analysis of the new model is carried out. Results of the nonlinear stability analysis are discussed in a later section; results of the linear stability analysis obtained in [Mar 6] and [Pel 1] are discussed below.

Pelaez and Linan [Pel 1] also study the structure of the front and stability of propagation of a two-stage combustion wave in a mode intermediate between control and coalescence regimes. This paper is the most complete of all those presented, in the sense that it contains the smallest number of limitations on the parameters of the problem. In it only equality of activation energies of both stages is assumed. The system of equations describing the indicated process and studied in the paper

has the form

$$(S.18) \quad \begin{aligned} \frac{\partial T}{\partial t} &= \varkappa \Delta T + q_1 F_1(T) + q_2 F_2(T), \\ \frac{\partial a}{\partial t} &= D_a \Delta a - a F_1(T), \\ \frac{\partial b}{\partial t} &= D_b \Delta b + a F_1(T) - b F_2(T), \end{aligned}$$

where D_a , D_b are diffusion coefficients. It is assumed that the combustion wave propagates along the x -axis and that the boundary conditions have the form

$$\begin{aligned} x = -\infty: \quad & a = 1, \quad b = 0, \quad T = T_i; \\ x = +\infty: \quad & a = b = 0, \quad \partial T / \partial x = 0. \end{aligned}$$

The stationary propagation speed has the form

$$(S.19) \quad u^2 = \frac{\varkappa \gamma^2}{\Lambda} k_1 \exp(-E/RT_b).$$

The dimensionless eigenvalue Λ of the problem and the distance $\gamma h \varkappa / u$ between the reaction zones must be found by solving the stationary formulation of (S.18). After an asymptotic analysis of the stationary problem it turns out that the system of equations for the leading terms of the expansions in the reaction zone does not yield an analytic solution except for the case, considered in [Mar 5], of a “similarity” in the parameters of the problem when

$$q_* = \frac{L_b k_2}{L_a k_1}, \quad q_* \equiv \frac{q_1}{q_1 + q_2}, \quad L_a = \frac{\varkappa}{D_a}, \quad L_b = \frac{\varkappa}{D_b};$$

here we find that $\Lambda = (2q_* L_a)^{-1}$. In the general case a numerical solution was carried out and the following limiting cases were considered:

$$\frac{L_b k_2}{L_a k_1} \gg 1, \quad \frac{L_b k_2}{L_a k_1} \ll 1,$$

in which we obtained, respectively, the results

$$\Lambda \approx \frac{1}{2L_a} + \frac{1 - q_*}{L_b} \frac{k_1}{k_2}; \quad \Lambda \approx \frac{(1 - q_*)^2}{2L_b} \frac{k_1}{k_2}.$$

These limiting cases correspond to regimes of full coalescence and control with the speeds (S.19) corresponding to single-stage processes. One could avoid analytical difficulties by considering zero order reactions which maintain all the quantitative characteristics of a more realistic kinetics.

In studying the nonstationary problem (S.18), the authors, as in [Mar 6] also, carried out a matching of asymptotic expansions, on the basis of which they proposed a model of a process with infinitely narrow reaction zones. Following this,

they studied the stability of a stationary wave for the simplified model and derived the dispersion relation

$$(S.20) \quad \begin{aligned} l_0(\Gamma - 1 - 2\Omega) + 2\Gamma^2(\Gamma - 1) &= h\Gamma[\Gamma - 1 + 2\Omega(L_b - 1) + 2L_b\Gamma_b], \\ l_0 &= (L_a - 1)/\gamma, \quad \Gamma_b = \frac{1}{2} \left[L_b - \sqrt{L_b^2 + 4\Omega L_b + 4s^2} \right]. \end{aligned}$$

The authors studied in detail the limiting case $h \gg 1$, $|L_b - 1| \ll 1$, so that $\delta = h(L_b - 1) \sim 1$. The dispersion relation in this case acquires the form

$$(S.21) \quad l_0(\Gamma - 1 - 2\Omega) + 2\Gamma^2(\Gamma - 1) + \delta(\Gamma - 1)(\Gamma - 1 - 2\Omega) = 0$$

and on the plane of the parameters (l_0, δ) regions are defined that correspond to the stable propagation of a combustion wave. In crossing the stability boundary various types of stability loss are possible on different parts of the boundary. Thus, we can have cellular instability ($\Omega = 0$), oscillatory instability with respect to one-dimensional perturbations ($\text{Re } \Omega = 0, s = 0$), oscillatory instability with respect to two-dimensional perturbations ($\text{Re } \Omega = 0, s \neq 0$), or a loss of stability with passage of a real eigenvalue through an infinity ($\Omega \sim (\delta - 4)^{-1}$). The latter type of stability loss testifies, apparently, to the inapplicability in these cases of representations concerning quasistationarity of a reaction zone. A study of the dispersion relation (S.20) shows that both the boundaries of stability and the types of stability loss are qualitatively the same as for (S.21).

In a paper by Pelaez [Pel 2] a study was made of the stability of propagation of a combustion wave in the control regime. System (S.18) was considered without the assumption of equality of activation energies of the stages. A scheme of the investigation is as follows: asymptotic analysis of the stationary problem; derivation of a simplified model with infinitely narrow reaction zones for the nonstationary problem; a study of stability within the framework of the simplified model. The stability boundaries and types of stability loss with passage through a boundary are analogous to the results presented in [Pel 1].

4.2. Independent reactions. The problem concerning propagation of a combustion wave, during the course of which there are independent reactions, is close to the problem involving sequential reactions. In [Vol 39] Vol'pert, Khaikin, and Khudyaev deduced conditions for the existence of various regimes in terms of the rates of single-stage processes, similar to what was done in [Kha 3]. Margolis and Matkowskii [Mar 9] investigated the coalescence regime.

4.3. Competing reactions. In the course of competing reactions one can expect phenomena connected with the nonuniqueness of a combustion wave since a reaction can proceed along either one of two parallel paths.

Nonuniqueness of a stationary combustion wave, in the case of the occurrence of parallel (competing) reactions (S.17), was first observed in papers of Khaikin and Khudyaev [Kha 4–7]. In these papers a physical clarification was given of the nature of nonuniqueness, followed by an analysis of the problem using the method of matched asymptotic expansions and by carrying out a numerical solution.

We turn our attention briefly to qualitative results obtained in [Kha 4–7] for the reaction scheme (S.17). For brevity, we shall assume that the activation energy E_1 is larger than E_2 (both activation energies are assumed to be large). We denote by T_j combustion temperatures during a separate passing of the stages, $T_j = T_i + q_j a_0$ ($j = 1, 2$), and by T_b the combustion temperature reached during

their joint passage. We consider separately the cases $q_1 > q_2$ and $q_1 < q_2$. In the first case, $T_1 > T_2$, and if

$$F_1(T_1) \gg F_2(T_1), \quad F_1(T_2) \ll F_2(T_2),$$

then, for the same values of the parameters, two different transformation modes are possible, in the first one the main part of the reactant is consumed in the first of the reactions, and T_b is close to T_1 ; in the second one, the converse is true. These two modes are separated by an unstable intermediate solution. In the second case, in which $T_2 > T_1$, nonuniqueness is not present.

Analysis of the stability of combustion waves corresponding to the scheme (S.17) is contained in a paper by Aldushin and Kasparyan [Ald 13]. We mention also the papers of Borovikov and Goldschleger [Borov 2] on parallel reactions with endothermic stages and of Nekrasov and Timokhin [Nek 3] on sequential-parallel reactions.

Along with the model reactions considered above, the literature contains even more involved reaction schemes. In [Zel 5] a rather detailed discussion is given of the application of approximate methods and of the matched asymptotic expansions method for some examples of chain flames and flames with a complex structure. In a paper by Clavin, Fife, and Nicolaenko [Cla 1] both (S.17) and



were considered. In the paper the origin of presented idealized schemes is discussed; physical considerations are given that testify to nonuniqueness of the combustion wave; in agreement with the above discussion an analysis of the stationary problem by the matched asymptotic expansions method is proposed; instability of the intermediate branch in the case of the presence of three solutions in the scheme (S.17) is proved. A conclusion is also drawn concerning the presence of a plateau in the dependence of T_b on a_0 in the case $T_2 > T_1$: over a wide range of variation of a_0 , T_b can be close to T_* , where T_* is determined from the equation $F_1(T_*) = F_2(T_*)$.

The reactions scheme (S.17) was discussed earlier, although not in such detail, in the paper by Fife and Nicolaenko [Fife 9]. In [Fife 10–12] the authors worked out general systematic methods, making it possible to clarify qualitative peculiarities of combustion waves for complex kinetic schemes.

§5. Transformations in a combustion wave

The effect of melting of reactants on propagation of a stationary combustion wave in a condensed medium was studied by Aldushin and Merzhanov [Ald 2, Mer 3]. The problem was considered in a very general setting and it was shown that under certain conditions on the temperature profile a plateau can arise at $T = T_m$, indicating two possible propagation modes: a Stefan mode and a chemical transformation mode. The effect of melting on the stability of a combustion wave propagating in a Stefan mode was investigated by Aldushin, Vol'pert, and Filipenko in [Ald 1].

Papers by Margolis [Mar 1, 2] and by Bayliss and Matkowskii [Bay 1] are devoted to these same problems. The formulations presented in all three of these papers are close to one another: the initial reactant, being found in deficit, melts instantaneously upon reaching the melting temperature T_m with latent heat L_m ; the final products are solid particles and heat losses in melting are compensated

by an increase of the thermal effect of the reaction after melting by L_m . The formulations in [Mar 1, 2] differ in the kinetics of the reactions; in [Bay 1] a numerical calculation is carried out based on the model presented in [Mar 1].

The system of equations in [Mar 1] has the form

$$\begin{aligned} \frac{\partial a}{\partial t} &= - \begin{pmatrix} 1 \\ \nu \end{pmatrix} aF(T) && \begin{pmatrix} x < \Pi(t, y, z) \\ x > \Pi(t, y, z) \end{pmatrix}, \\ \frac{\partial T}{\partial t} &= \varkappa \Delta T + \begin{pmatrix} q \\ \nu(q+l) \end{pmatrix} aF(T) && \begin{pmatrix} x < \Pi(t, y, z) \\ x > \Pi(t, y, z) \end{pmatrix}. \end{aligned}$$

Existence of a surface is assumed on which melting takes place,

$$x = \Pi(t, y, z), \quad T(t, \Pi, y, z) = T_m,$$

and the equations considered in regions before melting ($x < \Pi$) and after melting ($x > \Pi$) have a different form, since in the model it is assumed that there is an increase in the pre-exponential factor ($\nu > 1$) and in the thermal effect after melting. On the surface $x = \Pi$ there is specified the condition

$$(S.22) \quad \varkappa \bar{n} \nabla T \Big|_{x=\Pi-0}^{x=\Pi+0} = -l u_n a, \quad l = \frac{L_m}{c},$$

where \bar{n} is a unit vector to the surface Π ; u_n is the normal speed,

$$\bar{n} = \frac{\left(-\frac{\partial \Pi}{\partial y}, -\frac{\partial \Pi}{\partial z}, 1\right)}{\sqrt{1 + \left(\frac{\partial \Pi}{\partial y}\right)^2 + \left(\frac{\partial \Pi}{\partial z}\right)^2}}, \quad u_n = \left(0, 0, \frac{\partial \Pi}{\partial t}\right) \cdot \bar{n}.$$

Boundary conditions have the form

$$(S.23) \quad x = -\infty: \quad T = T_i, \quad a = 1; \quad x = +\infty: \quad T = T_b, \quad a = 0.$$

It is assumed that the melting temperature T_m is close to the combustion temperature $T_b = T_i + q$, i.e., melting takes place in the reaction zone.

The problem is solved by the method of matched asymptotic expansions with γ as a small parameter. In solving the stationary problem the propagation speed of a wave is found having a leading term in γ of the form

$$u^2 = \varkappa \gamma F(T_b) \left\{ \frac{\nu}{1 + q/l} - \left(\frac{\nu}{1 + q/l} - 1 \right) e^{E(T_m - T_b)/RT_b^2} \right\}.$$

Asymptotic analysis of the nonstationary problem was directed towards deriving a simplified model with an infinitely narrow reaction zone in which the heat liberation function is replaced by a δ -function of the spatial variable with a weight

reflecting the presence of melting in the reaction zone. In dimensionless variables this model has the form

$$(S.24) \quad \frac{\partial \theta}{\partial \tau} - \frac{\partial P}{\partial \tau} \frac{\partial \theta}{\partial \xi} = \Delta \theta - \frac{\partial P}{\partial \tau} \delta(\xi),$$

$$(S.25) \quad \frac{\partial P}{\partial \tau} = -\widehat{Q} \sqrt{1 + \left(\frac{\partial P}{\partial \eta}\right)^2 + \left(\frac{\partial P}{\partial \zeta}\right)^2},$$

$$(S.26) \quad \xi = -\infty: \theta = -1; \quad \xi = +\infty: \theta = 0,$$

$$(S.27) \quad \widehat{Q} = \left\{ \frac{\exp \tilde{\theta}/\gamma - M}{1 - M} \right\}^{1/2},$$

$$(S.28) \quad M = \left\{ 1 - \frac{1 + l/q}{\nu} \right\} \exp \frac{\theta_m}{\gamma}.$$

Here $\tilde{\theta} = \theta|_{s=0}$ is the nonstationary combustion temperature,

$$\theta_m = \frac{T_m - T_b}{T_b - T_i}, \quad P = \Pi \frac{u}{\varkappa},$$

$$\xi = \frac{u}{\varkappa} x, \quad \eta = \frac{u}{\varkappa} y, \quad \zeta = \frac{u}{\varkappa} z, \quad \tau = \frac{u^2}{\varkappa} t.$$

The system of coordinates in (S.24)–(S.25) is connected with the front of the nonstationary combustion wave (the reaction zone in the nonstationary process is located at $\xi = 0$); in this system of coordinates the Laplace operator Δ has the form

$$\Delta = \frac{\partial^2}{\partial \eta^2} + \frac{\partial^2}{\partial \zeta^2} + \left[1 + \left(\frac{\partial P}{\partial \eta}\right)^2 + \left(\frac{\partial P}{\partial \zeta}\right)^2 \right] \frac{\partial^2}{\partial \xi^2} - 2 \frac{\partial P}{\partial \eta} \frac{\partial^2}{\partial \eta \partial \xi}$$

$$- 2 \frac{\partial P}{\partial \zeta} \frac{\partial^2}{\partial \xi \partial \zeta} - \left(\frac{\partial^2 P}{\partial \eta^2} + \frac{\partial^2 P}{\partial \zeta^2} \right) \frac{\partial}{\partial \xi}.$$

A study of the stability for the simplified model leads to a dispersion relation with a single parameter, namely, the temperature coefficient Z_m of the wave speed; the dispersion relation itself coincides in form with that obtained in [Makh 1]. The difference resides in the expression for the temperature coefficient

$$(S.29) \quad Z_m = \left. \frac{\partial \widehat{Q}}{\partial \tilde{\theta}} \right|_{\tilde{\theta}=0} = \frac{1}{2\gamma(1 - M)},$$

taking melting in the reaction zone into account. The value $M = 0$ corresponds to the case without melting, and we then have $Z_m = Z$.

In [Mar 2] Margolis considers the same problem [Mar 1], but instead of a reaction of the first order, the kinetics is studied with deceleration of the reaction rate by means of products of the reaction

$$\varphi(a) = \frac{\exp(-m(1 - a))}{(1 - a)^n}.$$

In addition, it is assumed that the reaction does not proceed to the point where

melting occurs ($x < \Pi(t, y, z)$) and a second surface $x = \Phi(t, y, z)$ is introduced on which the reaction terminates ($a = 0$). Thus, the system of equations has the form

$$\begin{aligned} \frac{\partial a}{\partial t} &= - \begin{pmatrix} 0 \\ 1 \\ 0 \end{pmatrix} \varphi(a)F(T) && \begin{pmatrix} x < \Pi \\ \Pi < x < \Phi \\ \Phi < x \end{pmatrix}, \\ \frac{\partial T}{\partial t} &= \varkappa \Delta T + \begin{pmatrix} 0 \\ q+l \\ 0 \end{pmatrix} \varphi(a)F(T) && \begin{pmatrix} x < \Pi \\ \Pi < x < \Phi \\ \Phi < x \end{pmatrix}, \end{aligned}$$

with boundary conditions (S.23) and with conditions (S.22) on the melting surface.

The stationary propagation speed, with a leading term in γ , has the form

$$(S.30) \quad u^2 = \frac{\varkappa \gamma}{\lambda_{m,n}} F(T_b),$$

where

$$\lambda_{0,n} = \frac{1 + l/q}{(n+1)(n+2)(1 - \exp \theta_m/\gamma)}$$

($m = 0$, $n \geq 0$, real),

$$\lambda_{m,n} = \frac{1 + l/q}{(1 - \exp \theta_m/\gamma)} \left\{ \frac{(-1)^n (n+1)! (e^m - 1 - m/(n+1))}{m^{n+2}} - e^m \sum_{r=0}^n \frac{(-1)^r r n!}{m^{r+1} (n+1-r)} \right\}$$

($m > 0$, real; $n \geq 0$, integral). In case $-\theta_n \gg \gamma$ (i.e., $(T_b - T_m)E/RT_b^2 \gg 1$), melting shows no essential influence on the speed of propagation and formulas (S.30) agree with those obtained in [Ald 5].

The simplified asymptotic model coincides with (S.24)–(S.27), where M is given by the expression

$$M = \exp \frac{\theta_m}{\gamma}.$$

In [Bay 1] numerical calculations were carried out for a one-dimensional model [Mar 1] (see also [Bay 2]). A numerical algorithm was discussed in detail. The self-oscillational character of the propagation upon crossing the stability boundary was pointed out; also pointed out was the complication in the form of the oscillations and the doubling of the period upon receding from the boundary. For the model without melting a sequence of additional period doubling occurs, after which chaotic solutions are found, while the model with melting exhibits a route to chaos through intermittency [Bay 4].

In [Boo 3] a study was made of a stationary wave of combustion and its stability in the course of sequential reactions in the coalescence regime with reactant melting taken into account.

§6. Application of the methods of bifurcation theory to the study of nonstationary modes of propagation of combustion waves

In 1973 Merzhanov, Filonenko, and Borovinskaya [Mer 7] observed spinning modes of propagation of combustion waves in a condensed medium. This paper, although with great delay, attracted the attention of theoreticians and led to the

appearance of an increasing number of papers in which nonstationary combustion modes were investigated by the methods of bifurcation theory. Yet another starting point was furnished by the numerical results of Ivleva, Merzhanov, and Shkadinskiĭ [Ivl 2], which demonstrated the possibility of describing these modes using the simplest model of gasless combustion.

Before giving an account of papers dealing with the application of bifurcation theory, we point out experimental and numerical studies that appeared after [Mer 7] and [Ivl 2].

In [Fil 1–3] Filonenko and Vershinnikov studied regularities in spin combustion on hybrid systems (combustion of metal powders in nitrogen and in a mixture of nitrogen with an inert gas).

In [Mak 3, 4] Maksimov and co-authors investigated gasless systems of the type Ti–B, Ti–C, and others, with easily melted additions, and, depending on the dilution by the easily melted addition, succeeded in obtaining various nonstationary combustion modes in the same system.

In [Str 2, Dvo 2, Mer 5, Str 3, Vol 32, Dvo 3] Strunina, Dvoryankin, and Merzhanov investigated nonstationary combustion of thermite compounds. Close attention in these papers was given to the influence of the geometry of the specimen on non-one-dimensional modes of combustion.

Numerical studies of Ivleva, Merzhanov, and Shkadinskiĭ [Ivl 1, 3] are concerned with a two-dimensional formulation modeling the combustion of a cylindrical shell and a thin plate of a gasless composition. Three-dimensional problems were considered in subsequent papers by Scherbak and Radev [Rad 1, Sch 1, 2]: combustion of a specimen of a gasless compound in the shape of a circular cylinder and a long rod of square cross-section.

We mention also the papers of Aldushin, Zel'dovich, and Malomed [Ald 14, 16, 19, 20, Mal 1], carried out in the framework of a phenomenological approach, wherein the combustion front is interpreted as a system of thermally coupled oscillators.

The methods of bifurcation theory were first employed for the study of nonstationary non-one-dimensional modes of combustion to a problem in a general mathematical setting in [Vol 4, 13, 21, 29–31] (see Part II). Investigations were conducted of various nonstationary modes appearing at the loss of stability of a planar front.

Papers on application of the methods of bifurcation theory can be divided into three groups: papers concerned with models of gasless combustion; papers on gaseous combustion (our concern is with thermal diffusion models only); papers of a mathematical nature in which a problem is considered in a general mathematical setting.

We begin with the group of papers on gasless combustion and pause to consider in detail only one of them, the paper of Matkowskiĭ and Sivashinskiĭ [Mat 1], in which bifurcations of one-dimensional self-oscillational modes are studied.

The passage from a model of combustion with a distributed Arrhenius source to a model with a combustion surface (source in the form of a δ -function) brings us in [Mat 1] to a problem which, in dimensionless form in coordinates connected with the front of a nonstationary wave, may be written as

$$(S.31) \quad \frac{\partial \theta}{\partial \tau} + e^{Z\theta(\tau,0)} \frac{\partial \theta}{\partial \xi} = \frac{\partial^2 \theta}{\partial \xi^2}.$$

This equation must be solved for $\xi < 0$ (heating zone) and for $\xi > 0$ (combustion products) with the boundary conditions

$$(S.32) \quad \xi = -\infty: \theta = -1; \quad \sigma = +\infty: \frac{\partial \theta}{\partial \xi} = 0,$$

and the solutions in the product and heating regions are to be matched in the reaction zone ($\xi = 0$) in accordance with the formula

$$(S.33) \quad [\theta] = 0, \quad \left[\frac{\partial \theta}{\partial \xi} \right] + e^{Z\theta(\tau, 0)} = 0,$$

where the square brackets denote a jump of the function across the reaction zone:

$$[f] \equiv f(\xi + 0) - f(\xi - 0).$$

The stationary solution has the form

$$\theta_{st}(\xi) = \begin{cases} -1 + e^\xi & (\xi < 0), \\ 0 & (\xi > 0). \end{cases}$$

Problems of stability were discussed above: the stability boundary has the form $Z_0 = 2 + \sqrt{5}$; the frequency ψ_0 on the stability boundary is $\psi_0 = \sqrt{Z_0}/2$.

In obtaining periodic solutions of problem (S.31)–(S.33) (with period $2\pi/\psi$; the quantity ψ must be determined in solving the problem), which appear with the loss of stability of the stationary wave, we change over to a new time scale $\tau_1 = \psi\tau$, so that the unknown solutions will be 2π -periodic. Solutions are sought in the form of series in powers of a small parameter ε (ε is proportional to the amplitude of the self-oscillations that appear):

$$(S.34) \quad \theta(\tau_1, \xi) = \theta_{st}(\xi) + \varepsilon\theta_1(\tau_1, \xi) + \varepsilon^2\theta_2(\tau_1, \xi) + \dots,$$

$$(S.35) \quad Z = Z_0 + \varepsilon Z_1 + \varepsilon^2 Z_2 + \dots,$$

$$(S.36) \quad \psi = \psi_0 + \varepsilon\psi_1 + \varepsilon^2\psi_2 + \dots.$$

The substitution of (S.34)–(S.36) into equation (S.31), along with the conditions (S.32)–(S.33) and the separation of terms with identical powers of ε , leads to a chain of linear differential equations from which the coefficients in expansions (S.34)–(S.36) can be obtained. As a result, we find that $Z_1 = \psi_1 = 0$; $Z_2 > 0$, which means that the bifurcation is supercritical, the self-oscillating modes are stable and exist for $Z > Z_0$; $\psi_2 < 0$, which means that the dimensionless frequency decreases with the distance from the stability boundary. Moreover, the presented analysis shows that the average speed of propagation of a self-oscillational mode is less than the speed of a stationary wave (unstable for these values of the parameters); this result is in agreement with numerical simulations [Shk 3].

The leading term θ_1 of the expansion (S.34), giving the form of the self-oscillating mode close to the stability boundary, can be written as

$$\theta_1(\tau_1, \xi) = \begin{cases} e^{\mu\xi} [\cos(\tau_1 + \nu\xi) + 4\psi_0 \sin(\tau_1 + \nu\xi) - 4\psi_0 e^\xi \sin \tau_1] & (\xi < 0), \\ e^{(1-\mu)\xi} \cos(\tau_1 - \nu\xi) & (\xi > 0), \end{cases}$$

where

$$\mu = \frac{1 + \rho}{2}, \quad \nu = \frac{2\psi_0}{\rho}, \quad \rho^2 = \frac{1}{2} \left[1 + \sqrt{1 + 16\psi_0^2} \right].$$

We do not present the following term θ_2 of the expansion because of its complexity.

It should be noted that even in the simplest problems in the series of bifurcational problems the calculations turn out to be very involved; the study of bifurcations of non-one-dimensional nonstationary modes of wave propagation strongly requires the use of computers with programs of analytical operations (see, e.g., [Garb 3]).

In a paper by Sivashinskiĭ [Siv 2] spinning modes are described based on a linear analysis of the stability of a gasless combustion model with a source in the form of a δ -function. As the author remarks, a similar analysis does not answer a question concerning stability of appearing spinning modes and also the question as to whether bifurcations are supercritical or subcritical; these questions are not equivalent since the discussion here concerns bifurcations with multiple eigenvalues. In fact, the spinning modes obtained in the study of this model are unstable. In the papers of Matkowskĭ and co-authors [Mar 4, Garb 1, 2] nonlinear stability analysis was carried out on a model due to Margolis [Mar 1], a model which was described above and takes into account reactant melting in the reaction zone.

Before proceeding to a description of paper [Mar 4], we remark that although melting definitely plays a great role in gasless combustion systems, in the numerical studies [Rad 1, Sch 1, 2] stable spinning modes were observed close to the stability boundary in a model of gasless combustion without melting.

In [Mar 4] use was made of the model of [Mar 1] in which the combustion of a circular cylinder of a gasless compound with melting in the reaction zone was discussed. The stability boundary of a stationary wave, as noted above, is determined by a single parameter, the temperature coefficient Z_m of the wave speed, represented in the form of a combination of γ and M . Nonstationary modes present can, generally speaking, depend not on Z_m , but on the individuality of γ and M separately. Therefore, in [Mar 4], in an expansion in series in powers of a small parameter analogous to (S.34)–(S.36), instead of (S.35) we have

$$\begin{aligned}\gamma &= \gamma_0(1 + \gamma_2\varepsilon^2 + \dots), \\ M &= M_0(1 + M_2\varepsilon^2 + \dots),\end{aligned}$$

where γ_0 and M_0 are connected by relation (S.29) with $Z_m = 4$ (the authors consider the case in which loss of stability takes place across the minimum point of the function $Z(s^2)$). In this paper use is made of an approach connected with the introduction of various time scales. Without going into the details of the study, we present the results. The existence of spinning modes of combustion are shown for which the leading term θ_1 of an addition to the stationary solution in an expansion analogous to (S.34) has the form

$$\begin{aligned}(S.37) \quad \theta_1 &\sim \operatorname{Re} \left\{ \tilde{\theta}(\xi) e^{i\tilde{k}\varphi + i\tau_1} \right\} J_{\tilde{k}} \left(\frac{r\sigma_{\tilde{k}\tilde{n}}}{R} \right), \\ \theta_1 &\sim \operatorname{Re} \left\{ \tilde{\theta}(\xi) e^{-i\tilde{k}\varphi + i\tau_1} \right\} J_{\tilde{k}} \left(\frac{r\sigma_{\tilde{k}\tilde{n}}}{R} \right),\end{aligned}$$

which corresponds to left-turning and right-turning spinning modes. Here $\sigma_{\tilde{k}\tilde{n}}$ is the \tilde{n} th zero of the Bessel function of order \tilde{k} ; r , φ are polar coordinates in a cylinder cross-section; R is the cylinder radius. A proof was given for the existence of modes referred to as radial modes (limiting modes, in the terminology of [Mak 3, 4]),

which correspond to $\tilde{k} = 0$ in (S.37), and modes, referred to as standing modes (symmetric, in the terminology of [Vol 13, 21, 29–31]), with

$$\theta_1 \sim \operatorname{Re} \left\{ \tilde{\theta}(\xi) e^{i\tau_1} \right\} \cos \tilde{k}\varphi J_{\tilde{k}} \left(\frac{r\sigma_{\tilde{k}\tilde{n}}}{R} \right).$$

A study of the stability shows that for $M = 0$ (case without melting) spinning modes are subcritical (and, consequently, unstable), symmetric modes are supercritical, but also unstable. When M increases, a change in the stability of the modes can take place, for example, in the following sequence (the case $\tilde{k} = \tilde{n} = 2$ was considered): first, spinning modes become supercritical and stable while symmetric modes become supercritical and unstable; next, spinning modes are supercritical unstable, the symmetric modes supercritical and stable; then the spinning modes become supercritical unstable, the symmetric subcritical; after this, all modes are subcritical. In the case of one-spot spinning modes ($\tilde{k} = 1$) stable symmetric modes are not observed. Also described is the change of stability of the radial modes (for $\tilde{k} = 0, \tilde{n} = 2$): they are stable for $M = 0$ and lose stability as M increases.

These nonstationary combustion modes for a specimen in the shape of a circular cylinder are described in the Introduction and Chapters 6 and 7 to express where mathematical proofs are presented of the possibility, solutions in the form of a series in powers of a small parameter for distributed kinetics (for the model in [Mat 1] with a δ -function the mathematical proofs are contained in a paper by Roytburg [Roy 1]). A general mathematical formulation of the problem was also considered in the paper by Erneux and Matkowskii [Ern 3]. The use of many time scales in a two-parameter problem enabled the authors to study secondary bifurcations, leading to the appearance of quasiperiodic solutions.

In the paper by Booty and co-authors [Boo 1] a study was also made of the model in [Mar 1], with melting in the reaction zone taken into account. The situation considered was that in which the cylinder radius R is such that two wave numbers, $s_1 = \sigma_{k_1 n_1}/R$ and $s_2 = \sigma_{k_2 n_2}/R$, correspond to the same value of the temperature coefficient Z_m at the stability boundary: $Z_m(s_1^2) = Z_m(s_2^2)$. As a result, the authors arrive at a bifurcation with multiple eigenvalues, and they use the approach of [Reiss 1] connected with the splitting of the eigenvalues by means of a variation of the additional parameter (in the given case, the cylinder radius). Secondary and sequential bifurcations were obtained, leading to quasiperiodic modes.

Several papers are connected with the study of nonstationary modes of combustion of gases that are described by thermal diffusion models. Matkowskii and Olagunju [Mat 3] investigate the one-dimensional model of [Mat 2] and establish the existence in it of self-oscillational modes. Self-oscillational modes for sequential reactions occurring in a coalescence regime are described in the already-mentioned paper [Mar 6]. Supercriticality of the bifurcations and a decrease in the average speed of propagation in comparison with the uniformly propagating wave is shown. In later papers [Mat 5, 6] Matkowskii and Olagunju investigate non-one-dimensional nonstationary modes of gas combustion. Bifurcations connected with the loss of stability of a planar wave were also considered in [Ter 5] in which a study was made of the birth of periodic and stationary modes. In [Mar 8], similarly [Boo 1], Margolis and Matkowskii investigate degenerate bifurcations, the appearance of which is connected with a special selection of dimensions of the rectangular channel considered, in which a nonstationary gas combustion front is propagating. The appearance of secondary bifurcations of quasiperiodic modes

with the splitting of a multiple eigenvalue was investigated. (In connection with this approach, see also [Mar 10].) Nonstationary modes of nonadiabatic combustion were investigated in [Boo 2].

Interesting results were obtained by Matkowskii and co-authors in [Mat 4] and [Bay 5], and also by Buckmaster in [Buc 2, 3], in connection with gas combustion in a flow. In particular, in [Buc 3] a description are given of bifurcations of polyhedral flames, among them, flames rotating about an axis. A large number of papers are connected with cellular flames (see, for example, [Bay 3] and [Siv 5], and references therein).

§7. Surveys and monographs

Problems of the theory of combustion of condensed systems are discussed in the surveys of Merzhanov, Khaikin, and Aldushin [Ald 3, Mer 1, 2, Kha 1, Mer 8]. In some surveys problems of the theory of gasless combustion are touched upon partly. Such is the survey of Sivashinskiĭ [Siv 3], where the presentation is mainly carried out in terms of the Kuramoto-Sivashinskiĭ equation, now receiving world-wide dissemination, and the survey of Margolis and Matkowskii [Mar 7] mainly devoted to non-one-dimensional and nonstationary modes of combustion. The survey of Clavin [Cla 2] is concerned for the most part with the gasdynamics of combustion, but also contains sections which concern our present discussions. We mention also the monographs of Buckmaster and Ludford [Buc 5, 6] and the collections [Buc 4] and [Dyn 1].

Bibliography

- [Abr1] M. Abramowitz and I. A. Stegun, *Handbook of mathematical functions with formulas, graphs, and mathematical tables*, Applied Mathematics Series, vol. 55, National Bureau of Standards, Washington, D.C., 1964.
- [Adl1] J. Adler, *One-dimensional laminar flame propagation with distributed heat losses: Thin-flame theory*, *Combust. and Flame* **7** (1963), 39–49.
- [Agranat1] V. M. Agranat, V. N. Bertsun, and A. M. Grishin, *Chislennii metodi mekhaniki sploshnoi sredi*, vol. 10, 1979. (Russian)
- [Agranov1] M. S. Agranovich and M. I. Vishik, *Elliptic problems with a parameter and parabolic problems of general type*, *Russian Math. Surveys* **19** (1964), 53–175.
- [Ald1] A. P. Aldushin, V. A. Volpert, and V. P. Filipenko, *Effect of reagent melting on combustion stability of gasless systems*, *Combust., Expl. and Shock Waves* **23** (1987), 408–414.
- [Ald2] A. P. Aldushin and A. G. Merzhanov, *Gasless combustion with phase transformations*, *Dokl. Phys. Chem.* **236** (1977), 973–977.
- [Ald3] ———, *Theory of filtration combustion*, Propagation of Thermal Waves in Heterogeneous Media, “Nauka”, Novosibirsk, 1988, pp. 9–52. (Russian)
- [Ald4] A. P. Aldushin, A. G. Merzhanov, and B. I. Khaikin, *Some features of combustion of condensed systems with high-melting-point reaction products*, *Dokl. Phys. Chem.* **204** (1972), 475–477.
- [Ald5] A. P. Aldushin, T. M. Martemyanova, A. G. Merzhanov, B. I. Khaikin, and K. G. Skadinskiĭ, *Propagation of the front of an exothermic reaction in condensed mixtures with the interaction of the components through a layer of high melting product*, *Combust., Expl. and Shock Waves* **8** (1972), 159–167.
- [Ald6] ———, *Auto-vibrational propagation of the combustion front in heterogeneous condensed media*, *Combust., Expl. and Shock Waves* **9** (1973), 531–543.
- [Ald7] A. P. Aldushin, *Stationary propagation of an exothermic reaction front in a condensed medium*, *J. Appl. Mech. Tech. Phys.* **15** (1975), 363–370.
- [Ald8] A. P. Aldushin and B. I. Khaikin, *On propagation of combustion front through condensed mixture under reaction diffusion conditions*, *Theory and Technology Metallothermic Processes*, “Nauka”, Novosibirsk, 1974, pp. 11–22. (Russian)
- [Ald9] A. P. Aldushin and S. G. Kasparyan, *Thermally diffusive instability of combustion waves*, Preprint, *Inst. Chem. Phys., Chernogolovka*, 1978. (Russian)
- [Ald10] A. P. Aldushin, V. D. Lugovoi, A. G. Merzhanov, and B. I. Khaikin, *Conditions for degeneration of a steady combustion wave*, *Soviet Phys. Dokl.* **23** (1978), 914–916.
- [Ald11] A. P. Aldushin and S. G. Kasparyan, *Thermally diffusive instability of a combustion front*, *Soviet Phys. Dokl.* **24** (1979), 29–31.
- [Ald12] ———, *Effect of heat loss on combustion wave stability*, *Combust., Expl. and Shock Waves* **17** (1981), 177–180.
- [Ald13] ———, *Two-dimensional instability of the combustion front with parallel reactions*, *Khimicheskaya Fizika* **1** (1982), no. 10, 1412–1420; English transl. in *Soviet J. Chem. Phys.*
- [Ald14] A. P. Aldushin, Ya. B. Zel’dovich, and B. A. Malomed, *Spinning modes of propagation of the pulsating combustion front*, *Chemical Physics of the Processes of Combustion and Explosion. Combustion of Condensed and Heterogeneous Systems*, *Inst. Chem. Phys., Chernogolovka*, 1980, pp. 104–108. (Russian)

- [Ald15] ———, *Phenomenology of unstable combustion for small and large Lewis numbers*, Preprint No. 596, Space Research Inst., Moscow, 1980. (Russian)
- [Ald16] ———, *On the phenomenological theory of spin combustion*, Soviet Phys. Dokl. **25** (1980), 273–275.
- [Ald17] A. P. Aldushin, Ya. B. Zel'dovich, and S. I. Khudyaev, *Numerical investigation of flame propagation in a mixture reaction at the initial temperature*, Combust., Expl. and Shock Waves **15** (1979), 705–710.
- [Ald18] ———, *Flame propagation in a reacting gaseous mixture*, Arch. Combust. **1** (1981), 9–21.
- [Ald19] A. P. Aldushin and B. A. Malomed, *Phenomenological description of nonstationary nonuniform combustion waves*, Combust., Expl. and Shock Waves **17** (1981), 1–8.
- [Ald20] A. P. Aldushin, B. A. Malomed, and Ya. B. Zel'dovich, *Phenomenological theory of spin combustion*, Combust. and Flame **42** (1981), 1–6.
- [Alek1] V. V. Aleksandrov, Yu. A. Kovalenko, and N. P. Poddubnyi, *Simulation of nonadiabatic gasless combustion with account for variable thermophysical properties and non one-dimensional fronts*, Propagation of Thermal Waves in Heterogeneous Media, "Nauka", Novosibirsk, pp. 93–107. (Russian)
- [Alek2] V. V. Aleksandrov, A. A. Davydenko, Yu. A. Kovalenko, and N. P. Poddubnyi, *Influence of two-dimensionality of the front with heat losses on the limits of stationary gasless combustion*, Combust., Expl. and Shock Waves **23** (1987), 182–191.
- [Ale1] J. C. Alexander, *Asymmetric rotating wave solutions of reaction-diffusion equations*, Nonlinear Functional Analysis and Its Applications. Part 1 (Berkeley, CA, 1983), Proc. Sympos. Pure Math., vol. 45, Amer. Math. Soc., Providence, RI, 1986, pp. 7–15.
- [Ale2] J. Alexander, R. Gardner, and C. Jones, *A topological invariant arising in the stability analysis of travelling waves*, J. Reine Angew. Math. **410** (1990), 167–212.
- [Ang1] S. B. Angenent and B. Fiedler, *The dynamics of rotating waves in scalar reaction diffusion equations*, Trans. Amer. Math. Soc. **307** (1988), 545–568.
- [Ami1] C. J. Amick, *Semilinear elliptic eigenvalue problems on an infinite strip with an application to stratified fluids*, Ann. Scuola Norm. Sup. Pisa Cl. Sci. (4) **11** (1984), 441–499.
- [Aro1] D. G. Aronson and H. F. Weinberger, *Nonlinear diffusion in population genetics, combustion, and nerve pulse propagation*, Partial Differential Equations and Related Topics (New Orleans, LA, 1974), Lecture Notes in Math., vol. 446, Springer-Verlag, Berlin and New York, 1975, pp. 5–49.
- [Aro2] ———, *Multidimensional nonlinear diffusion arising in population genetics*, Adv. Math. **30** (1978), 33–76.
- [Atk1] C. Atkinson, G. E. H. Reuter, and C. J. Ridler-Rowe, *Traveling wave solution for some nonlinear diffusion equations*, SIAM J. Math. Anal. **12** (1981), 880–892.
- [Auc1] J. F. G. Auchmuty, *Bifurcating waves*, Bifurcation Theory and Applications in Scientific Disciplines (New York, 1977), Ann. New York Acad. Sci., vol. 316, New York Acad. Sci., New York, 1979, pp. 263–278.
- [Auc2] ———, *Bifurcation analysis of reaction diffusion equations. V. Rotating waves on a disc*, Partial Differential Equations and Dynamical Systems, Res. Notes in Math., vol. 101, Pitman, Boston, 1984, pp. 35–63.
- [Aut1] *Autowave processes in systems with diffusion*, Inst. Appl. Phys., Gorky, 1981. (Russian)
- [Aza1] V. V. Azatyan, R. G. Aivazyan, V. A. Kalkanov, A. G. Merzhanov, S. A. Tsyganov, and A. A. Shavard, *Principles of nonthermal flame propagation in mixtures of silane and oxygen*, Khimicheskaya Fizika **4** (1985), no. 10, 1409–1416; English transl. in Soviet J. Chem. Phys.
- [Bac1] R. D. Bachelis and V. G. Melamed, *Concerning the nonuniqueness of the stationary solutions of the system of equations of combustion theory when the rate constant and the coefficient of thermal conduction and diffusion are piecewise constant*, Soviet Phys. Dokl. **10** (1966), 730–733.
- [Bare1] V. V. Bareiko, *Self-organization phenomena and autowave processes in heterogeneous chemical and physical systems*, Self-organization, Springer Ser. Synergetics, vol. 28, Springer-Verlag, Berlin and New York, 1984, pp. 164–167.

- [Ban1] C. Bandle and A. Tesei, *On space-periodic solutions for a class of semilinear elliptic problems*, Stability Appl. Anal. Contin. Media **1** (1991), 109–126.
- [Baren1] G. I. Barenblatt, *Comments to: A study of the equation of diffusion with increase in the quantity of matter, with application to a biological problem*, Selected Works. Mathematics and Mechanics, “Nauka”, Moscow, 1985. (Russian)
- [Baren2] G. I. Barenblatt and Ya. B. Zel’dovich, *On stability of flame propagation*, Prikl. Mat. Mekh. **21** (1957), 856–859. (Russian)
- [Baren3] G. I. Barenblatt, Ya. B. Zel’dovich, and A. G. Istratov, *On thermal-diffusive stability of a laminar flame*, Zh. Prikl. Mekh. i Tekhn. Fiz. **1962**, no. 4, 21–26; English transl. in J. Appl. Mech. Tech. Phys.
- [Baren4] G. I. Barenblatt and Ya. B. Zel’dovich, *Intermediate asymptotics in mathematical physics*, Russian Math. Surveys **26** (1971), 45–61.
- [Baren5] G. I. Barenblatt, *Similarity, self-similarity, and intermediate asymptotics*, Consultants Bureau, New York and London, 1979.
- [Bark1] D. Barkley, *Linear stability analysis of rotating spiral waves in excitable media*, Phys. Rev. Lett. **68** (1992), 2090–2093.
- [Barles1] G. Barles, L. Bronsard, and P. E. Souganidis, *Front propagation for reaction-diffusion equations of bistable type*, Ann. Inst. H. Poincaré Anal. Non Linéaire **9** (1992), 479–496.
- [Bar1] D. L. Barrow and P. W. Bates, *Bifurcation of periodic travelling waves for a reaction-diffusion system*, Ordinary and Partial Differential Equations (Dundee, 1982), Lecture Notes in Math., vol. 964, Springer-Verlag, Berlin and New York, 1982, pp. 69–76.
- [Bar2] ———, *Bifurcation and stability of periodic travelling waves for a reaction-diffusion system*, J. Differential Equations **50** (1983), 218–233.
- [Bay1] A. Bayliss and B. J. Matkowsky, *Fronts, relaxation oscillations, and period doubling in solid fuel combustion*, J. Comput. Phys. **71** (1987), 147–168.
- [Bay2] A. Bayliss, B. J. Matkowsky, and M. Minkoff, *Period doubling gained, period doubling lost*, SIAM J. Appl. Math. **49** (1989), 1047–1063.
- [Bay3] ———, *Cascading cellular flames*, SIAM J. Appl. Math. **49** (1989), 1421–1432.
- [Bay4] ———, *Two routes to chaos in condensed phase combustion*, SIAM J. Appl. Math. **50** (1990), 437–459.
- [Bay5] ———, *From traveling waves to chaos in combustion* (to appear).
- [Beb1] J. Bebernes and D. Eberly, *Mathematical problems from combustion theory*, Appl. Math. Sci., vol. 83, Springer-Verlag, New York, 1989.
- [Beg1] V. P. Begishev, V. A. Volpert, S. P. Davtyan, and A. Ya. Malkin, *Some features of the anionic activated ϵ -caprolactam polymerization under wave propagation conditions*, Dokl. Phys. Chem. **29** (1984), 1075–1077.
- [Bel1] J. Bell, *A note on the stability of traveling-wave solutions to a class of reaction-diffusion systems*, Quart. Appl. Math. **38** (1981), 489–496.
- [Bel2] J. Bell and C. Cosner, *Stability properties of a model of parallel nerve fibers*, J. Differential Equations **40** (1981), 303–315.
- [Bel3] J. Bell and L. P. Cook, *On the solutions of a nerve conduction equation*, SIAM J. Appl. Math. **35** (1978), 678–688.
- [Bel4] J. Bell and C. Cosner, *Wave-like solutions to reaction-diffusion equations on a cylinder: dependence on cylinder width*, SIAM J. Appl. Math. **47** (1987), 534–543.
- [Beres1] H. Berestycki, B. Larrouturou, and P. L. Lions, *Multi-dimensional travelling wave solutions of a flame propagation model*, Arch. Rational Mech. Anal. **111** (1990), 33–49.
- [Beres2] H. Berestycki and B. Larrouturou, *A semi-linear elliptic equation in a strip arising in a two-dimensional flame propagation model*, J. Reine Angew. Math. **396** (1989), 14–40.
- [Beres3] H. Berestycki and L. Nirenberg, *Travelling front solutions of semilinear equations in n dimensions*, Frontiers in Pure Appl. Math., North-Holland, Amsterdam, 1991, pp. 31–41.
- [Beres4] H. Berestycki, B. Nicolaenko, and B. Scheurer, *Travelling wave solutions to combustion models and their singular limits*, SIAM J. Math. Anal. **16** (1985), 1207–1242.
- [Beres5] H. Berestycki and L. Nirenberg, *Some qualitative properties of solutions of semilinear elliptic equations in cylindrical domains*, Analysis, et cetera (P. H. Rabinovitz and E. Zehnder, eds.), Academic Press, Boston, 1990, pp. 115–164.

- [Beres6] H. Berestycki, B. Larroutourou, and J. M. Roquejoffre, *Stability of travelling fronts in a model for flame propagation. Part I: Linear analysis*, Arch. Rational Mech. Anal. **117** (1992), 97–117.
- [Beres7] H. Berestycki and L. Nirenberg, *Travelling fronts in cylinders*, Ann. Inst. H. Poincaré Anal. Non Linéaire **9** (1992), 497–572.
- [Berg1] M. Berger and R. V. Kohn, *A rescaling algorithm for the numerical calculation of blowing-up solutions*, Comm. Pure Appl. Math. **41** (1988), 841–863.
- [Berm1] V. S. Berman and Yu. S. Ryazantsev, *Asymptotic analysis of stationary propagation of the front of a two-stage exothermic reaction in a gas*, J. Appl. Math. Mech. **37** (1973), 995–1004.
- [Berm2] ———, *Asymptotic front propagation analysis for a single-stage reaction of order n in a condensed phase*, Combust., Expl. and Shock Waves **11** (1976), 155–162.
- [Bern1] A. J. Bernoff, *Spiral wave solutions for reaction-diffusion equations in a fast reaction/slow diffusion limit*, Phys. D **53** (1991), 125–150.
- [Bil1] J. Billingham and D. J. Needham, *The development of travelling waves in quadratic and cubic autocatalysis with unequal diffusion rates. I. Permanent form travelling waves*, Philos. Trans. Roy. Soc. London Ser. A **334** (1991), 1–24.
- [Bil2] ———, *The development of travelling waves in quadratic and cubic autocatalysis with unequal diffusion rates. II. An initial value problem with an immobilized or nearly immobilized autocatalyst*, Philos. Trans. Roy. Soc. London Ser. A **336** (1991), 497–539.
- [Bil3] ———, *The development of travelling waves in quadratic and cubic autocatalysis with unequal diffusion rates. III. Large time development in quadratic autocatalysis*, Quart. Appl. Math. **50** (1992), 343–372.
- [Bon1] A. Bonnet, *Travelling waves for planar flames with complex chemistry reaction network*, Comm. Pure Appl. Math. **45** (1992).
- [Bon2] ———, *Non-uniqueness for flame propagation when Lewis number is less than 1* (to appear).
- [Boo1] M. R. Booty, S. B. Margolis, and B. J. Matkowsky, *Interaction of pulsating and spinning waves in condensed phase combustion*, SIAM J. Appl. Math. **46** (1986), 801–843.
- [Boo2] ———, *Interaction of pulsating and spinning waves in nonadiabatic flame propagation*, SIAM J. Appl. Math. **47** (1987), 1241–1286.
- [Boo3] M. R. Booty, J. B. Holt, and B. J. Matkowsky, *Condensed phase combustion with a merged sequential reaction mechanism*, Quart. J. Mech. Appl. Math. **43** (1990), 223–249.
- [Boris1] O. A. Borisova, B. V. Lidskiĭ, M. G. Neigauz, and B. V. Novozhilov, *Stability of gasless system combustion against two-dimensional perturbations*, Khimicheskaya Fizika **5** (1986), no. 6, 822–830; English transl. in Soviet J. Chem. Phys.
- [Borov1] M. V. Borovikov, I. A. Burovoĭ, and U. I. Goldshleger, *Combustion wave propagation in system of sequential reactions with endothermic stages*, Combust., Expl. and Shock Waves **20** (1984), 241–248.
- [Borov2] M. V. Borovikov and U. I. Goldshleger, *On nonuniqueness of the stationary combustion waves for occurrence of competing exo- and endothermic reactions*, Preprint, Inst. Chem. Phys., Chernogolovka, 1984.
- [Bot1] F. Booth, *The theory of self-propagating exothermic reactions in solid systems*, Trans. Faraday Soc. **49** (1953), 272–281.
- [Bow1] J. R. Bowen, N. Manson, A. K. Oppenheim, and R. I. Soloukhin (eds.), *Dynamics of flames and reactive systems*, Progress in Astronautics and Aeronautics, vol. 95, Amer. Inst. Aeronautics and Astronautics, New York, 1984.
- [Boy1] S. F. Boys and J. Corner, *The structure of the reaction zone in a flame*, Proc. Roy. Soc. London Ser. A **197** (1949), 90–106.
- [Bra1] M. Bramson, *Convergence of solutions of the Kolmogorov equation to travelling waves*, Mem. Amer. Math. Soc. **285** (1983), 1–190.
- [Brau1] C. M. Brauner and Cl. Schmidt-Lainé, *Existence of a solution to a certain plane premixed flame problem with two-step kinetics*, SIAM J. Math. Anal. **18** (1987), 1406–1415.
- [Brau2] C. M. Brauner, A. Lunardi, and Cl. Schmidt-Lainé, *Stability of travelling waves with interface conditions*, Nonlinear Anal. **19** (1992), 455–474.

- [Brau3] C. M. Brauner, S. Noor Ebad, and Cl. Schmidt-Lainé, *Nonlinear stability analysis of singular travelling waves in combustion — a one phase problem*, *Nonlinear Anal.* **16** (1991), 881–892.
- [Brazh1] P. K. Brazhnik, V. A. Davydov, V. S. Zykov, and A. S. Mikhailov, *Vortex rings in excitable media*, *Soviet Phys. JETP* **66** (1987), 984–990.
- [Bri1] N. F. Britton, *Threshold phenomena and solitary travelling waves in a class of reaction-diffusion systems*, *SIAM J. Appl. Math.* **42** (1982), 188–217.
- [Bron1] L. Bronsard and R. V. Kohn, *Motion by mean curvature as the singular limit of Ginzburg-Landau dynamics*, *J. Differential Equations* **90** (1991), 211–237.
- [Bron2] ———, *On the slowness of phase boundary motion in one space dimension*, *Comm. Pure Appl. Math.* **43** (1990), 983–997.
- [Brow1] K. J. Brown and A. A. Lacey (eds.), *Reaction-diffusion equations*, Clarendon Press, Oxford, 1990.
- [Buc1] J. Buckmaster, *The quenching of deflagration waves*, *Combust. and Flame* **26** (1976), 151–162.
- [Buc2] ———, *Stability of the porous plug burner flame*, *SIAM J. Appl. Math.* **43** (1983), 1335–1349.
- [Buc3] ———, *Polyhedral flames — an exercise in bimodal bifurcation analysis*, *SIAM J. Appl. Math.* **44** (1984), 40–55.
- [Buc4] ———, *The mathematics of combustion*, *Frontiers Appl. Math.*, vol. 2, SIAM, Philadelphia, PA, 1985.
- [Buc5] J. Buckmaster and G. S. Ludford, *Theory of laminar flames*, Cambridge Univ. Press, Cambridge, 1982.
- [Buc6] ———, *Lectures on mathematical combustion*, *CBMS-NSF Regional Conf. Ser. in Appl. Math.*, vol. 43, SIAM, Philadelphia, PA, 1983.
- [Buc7] J. D. Buckmaster and T. Takeno (eds.), *Mathematical modeling in combustion science*, *Lecture Notes in Phys.*, vol. 299, Springer-Verlag, New York, 1988.
- [Byk1] V. I. Bykov, *Modeling of critical phenomena in chemical kinetics*, “Nauka”, Moscow, 1988. (Russian)
- [Cag1] G. Caginalp and Y. Nishiura, *The existence of traveling waves for phase field equation and convergence to sharp interface models in the singular limit*, *Quart. Appl. Math.* **49** (1991), 147–162.
- [Car1] G. A. Carpenter, *Nerve impulse equations*, *Lecture Notes in Math.*, vol. 525, Springer-Verlag, New York, 1976, pp. 58–76.
- [Car2] ———, *A geometric approach to singular perturbation problems with applications to nerve impulse equations*, *J. Differential Equations* **23** (1977), 335–367.
- [Car3] ———, *Periodic solutions of nerve impulse equations*, *J. Math. Anal. Appl.* **58** (1977), 152–173.
- [Cas1] R. Casten, H. Cohen, and P. Lagerstrom, *Perturbation analysis of an approximation to Hodgkin-Huxley theory*, *Quart. Appl. Math.* **32** (1975), 365–402.
- [Chu1] K. N. Chueh, *On the asymptotic behaviour of solutions of semilinear parabolic partial equations*, Ph.D. Thesis., Univ. Wisconsin, 1975.
- [Chu2] ———, *A compact positively invariant set of solutions of the Nagumo equation*, *J. Differential Equations* **28** (1978), 35–42.
- [Cla1] P. Clavin, P. Fife, and B. Nicolaenko, *Multiplicity and related phenomena in competing reaction flames*, *SIAM J. Appl. Math.* **47** (1987), 296–331.
- [Cla2] P. Clavin, *Dynamic behavior of premixed flame fronts in laminar and turbulent flows*, *Progr. Energy Combust. Sci.* **11** (1985), 1–59.
- [Coh1] D. S. Cohen, J. C. Neu, and R. R. Rosales, *Rotating spiral wave solutions of reaction-diffusion equations*, *SIAM J. Appl. Math.* **35** (1978), 536–547.
- [Col1] P. Collet and J.-P. Eckman, *Instabilities and fronts in extended systems*, *Princeton Ser. Phys.*, Princeton Univ. Press, Princeton, NJ, 1990.
- [Con1] C. C. Conley, *Isolated invariant sets and the Morse index*, *CBMS Regional Conf. Ser. in Math.*, vol. 38, Amer. Math. Soc., Providence, RI, 1978.
- [Con2] C. C. Conley and R. Gardner, *An application of generalized Morse index to travelling wave solutions of a competitive reaction-diffusion model*, *Indiana Univ. Math. J.* **33** (1984), 319–343.
- [Con3] C. C. Conley and J. A. Smoller, *Remarks on travelling wave solutions of nonlinear diffusion equations*, *Lecture Notes in Math.*, vol. 525, Springer-Verlag, Berlin and

- New York, 1976, pp. 77–89.
- [Con4] C. C. Conley, *On traveling wave solutions of nonlinear diffusion equations*, Dynamical Systems, Theory and Applications, Lecture Notes in Phys., vol. 38, Springer-Verlag, Berlin, 1975, pp. 539–549.
- [Con5] C. C. Conley and P. Fife, *Critical manifolds, traveling waves, and an example from population genetics*, J. Math. Biol. **14** (1982), 159–176.
- [Con6] C. C. Conley and J. A. Smoller, *Isolated invariant sets of parameterized systems of differential equations*, The Structure of Attractors in Dynamical Systems, Lecture Notes in Math., vol. 668, Springer-Verlag, Berlin, 1978, pp. 30–47.
- [Dal1] Ju. L. Daletckii and M. G. Krein, *Stability of solutions of differential equations in Banach space*, Transl. Math. Monographs, vol. 43, Amer. Math. Soc., Providence, RI, 1974.
- [Dan1] V. G. Danilov, *Asymptotic solutions of traveling wave type for semilinear parabolic equations with a small parameter*, Mat. Zametki **48** (1990), no. 2, 148–151; English transl. in Math. Notes **24** (1990).
- [Dan2] V. G. Danilov and P. Yu. Subochev, *Wave solutions of semilinear parabolic equations*, Theoret. and Math. Phys. **89** (1991), 1029–1046.
- [Den1] E. T. Denisov, *Kinetics of homogeneous chemical reaction*, Vysshaya Shkola, Moscow, 1978. (Russian)
- [Den2] Yu. N. Denisov and Ya. K. Troshin, *Structure of gaseous detonation in tubes*, Soviet Physics – Technical Physics **5** (1960), 419–431.
- [Den3] ———, *On the discrete character of a change in structure of a gas detonation wave*, Zh. Prikl. Mekh. i Tekhn. Fiz. **1967**, no. 2, 90–92; English transl. in J. Appl. Mech. Tech. Phys.
- [Deng1] B. Deng, *The existence of infinitely many traveling front and back waves in the FitzHugh-Nagumo equations*, SIAM J. Math. Anal. **22** (1991), 1631–1650.
- [Dik1] A. S. Dikansky, *Diffusion equations with nonlinear kinetics*, Preprint No. 14055-80, deposited at VINITI, 1980. (Russian)
- [Dim1] P. Dimitriou, J. Puszynski, and V. Hlaváček, *On the dynamics of equations describing gasless combustion in condensed systems*, Combust. Sci. and Technol. **68** (1989), 101–111.
- [Duf1] M. R. Duffy, N. F. Britton, and J. D. Murray, *Spiral wave solutions of practical reaction-diffusion systems*, SIAM J. Appl. Math. **39** (1980), 8–13.
- [Dun1] S. R. Dunbar, *Travelling wave solutions of diffusive Lotka-Volterra equations: a heteroclinic connection in \mathbb{R}^4* , Trans. Amer. Math. Soc. **286** (1984), 557–594.
- [Dun2] ———, *Travelling wave in diffusive predator-prey equations: periodic orbits and point-to-periodic heteroclinic orbits*, SIAM J. Appl. Math. **46** (1986), 1057–1078.
- [Doc1] J. D. Dockery, J. P. Keener, and J. J. Tyson, *Dispersion of traveling waves in the Belousov-Zhabotinskiĭ reaction*, Phys. D **30** (1988), 177–191.
- [Doc2] J. D. Dockery and R. Lui, *Existence of traveling wave solutions for a bistable evolutionary ecology model*, SIAM J. Math. Anal. **23** (1992), 870–888.
- [Dvo1] A. V. Dvoryankin, A. G. Strunina, and A. G. Merzhanov, *Temperature fields and combustion stability in gasless systems*, Combust., Expl. and Shock Waves **24** (1984), 467–471.
- [Dvo2] ———, *Trends in the spin combustion of thermites*, Combust., Expl. and Shock Waves **18** (1982), 134–139.
- [Dvo3] ———, *Stability of combustion in thermite systems*, Combust., Expl. and Shock Waves **21** (1985), 421–425.
- [Dyn1] P. C. Fife, A. Linan, and F. Williams (eds.), *Dynamical issues in combustion theory*, IMA Vol. Math. Appl., vol. 35, Springer-Verlag, New York, 1991.
- [Ema1] N. M. Emanuel' and D. G. Knorre, *Course in chemical kinetics*, Vysshaya Shkola, Moscow, 1984. (Russian)
- [Eng1] H. Engler, *Relations between travelling wave solutions of quasilinear parabolic equations*, Proc. Amer. Math. Soc. **93** (1985), 297–302.
- [Erm1] G. B. Ermentrout, *Stable small-amplitude solutions in reaction-diffusion systems*, Quart. Appl. Math. **39** (1981), 61–86.
- [Erm2] G. B. Ermentrout and J. Rinzel, *Waves in a simple, excitable or oscillatory, reaction-diffusion model*, J. Math. Biol. **11** (1981), 269–294.
- [Erm3] G. B. Ermentrout, S. P. Hastings, and W. C. Troy, *Large amplitude stationary waves*

- in an excitable lateral-inhibitory medium*, SIAM J. Appl. Math. **44** (1984), 1133–1149.
- [Erm4] G. B. Ermentrout and J. Rinzel, *One dimensional $\lambda - \omega$ target patterns: empirical stability tests*, J. Math. Biol. **10** (1980), 97–100.
- [Ern1] T. Erneux, *Stability of rotating chemical waves*, J. Math. Biol. **12** (1981), 199–214.
- [Ern2] T. Erneux and M. Herschkowitz-Kaufman, *Rotating waves as asymptotic solutions of a model chemical reaction*, J. Chem. Phys. **66** (1977), 248–253.
- [Ern3] T. Erneux and B. J. Matkowsky, *Quasiperiodic waves along a pulsating propagating front in a reaction-diffusion system*, SIAM J. Appl. Math. **44** (1984), 536–544.
- [Esc1] M. Escobedo and O. Kavian, *Variational problems related to self-similar solutions of the heat equation*, Nonlinear Anal. **11** (1987), 1103–1133.
- [Esq1] J. Esquinas and M. A. Herrero, *Traveling wave solutions to a semilinear diffusion system*, SIAM J. Math. Anal. **21** (1990), 123–136.
- [Eva1] J. W. Evans, *Nerve axon equations. I. Linear approximations*, Indiana Univ. Math. J. **21** (1972), 877–885.
- [Eva2] ———, *Nerve axon equations. II. Stability at rest*, Indiana Univ. Math. J. **22** (1972), 75–90.
- [Eva3] ———, *Nerve axon equations. III. Stability of the nerve impulse*, Indiana Univ. Math. J. **22** (1972), 577–593.
- [Eva4] ———, *Nerve axon equations. IV. The stable and the unstable impulse*, Indiana Univ. Math. J. **24** (1975), 1169–1190.
- [Eva5] J. W. Evans, N. Fenichel, and J. A. Feroe, *Double impulse solutions in nerve axon equations*, SIAM J. Appl. Math. **42** (1982), 219–234.
- [Eva6] J. W. Evans and J. A. Feroe, *Local stability theory of the nerve impulse*, Math. Biosci. **37** (1977), 23–50.
- [Fei1] M. Feinberg and D. Terman, *Traveling composition waves on isothermal catalyst surfaces*, Arch. Rational Mech. Anal. **116** (1991), 35–69.
- [Fer1] J. A. Feroe, *Temporal stability of solitary impulse solutions of a nerve equation*, Biophys. J. **21** (1978), 103–110.
- [Fer2] ———, *Travelling waves of infinitely many pulses in nerve equations*, Math. Biosci. **55** (1981), 189–203.
- [Fer3] ———, *Existence and stability of multiple impulse solutions of a nerve equation*, SIAM J. Appl. Math. **42** (1982), 235–246.
- [Fie1] R. J. Field and W. C. Troy, *The existence of solitary traveling wave solutions of a model of the Belousov-Zhabotinskiĭ reaction*, SIAM J. Appl. Math. **37** (1979), 561–587.
- [Fife1] P. C. Fife, *Asymptotic states for equations of reaction and diffusion*, Bull. Amer. Math. Soc. **84** (1978), 693–726.
- [Fife2] ———, *The bistable nonlinear diffusion equations, basic theory and some applications*, Applied Nonlinear Analysis, Academic Press, New York and London, 1979, pp. 143–160.
- [Fife3] ———, *Mathematical aspects of reacting and diffusing systems*, Lecture Notes in Biomath., vol. 28, Springer-Verlag, Berlin, 1979.
- [Fife4] ———, *Wave-fronts and target patterns*, Applications of Nonlinear Analysis in the Physical Sciences, Pitman, Boston and London, 1981.
- [Fife5] ———, *On the question of existence and nature of homogeneous-center target patterns in the Belousov-Zhabotinskiĭ reaction*, Analytical and Numerical Approaches to Asymptotic Problems in Analysis, North-Holland Math. Stud., vol. 47, North-Holland, Amsterdam and New York, 1981.
- [Fife6] P. C. Fife and J. B. McLeod, *The approach of solutions of nonlinear diffusion equations to travelling wave solutions*, Bull. Amer. Math. Soc. **81** (1975), 1076–1078.
- [Fife7] ———, *The approach of solutions of nonlinear diffusion equations to travelling front solutions*, Arch. Rational Mech. Anal. **65** (1977), 335–361.
- [Fife8] ———, *A phase plane discussion of convergence to travelling fronts for nonlinear diffusion*, Arch. Rational Mech. Anal. **75** (1981), 281–314.
- [Fife9] P. Fife and B. Nicolaenko, *How chemical structure determines spatial structure in flame profiles*, Modelling of Patterns in Space and Time (Heidelberg, 1983), Lecture Notes in Biomath., vol. 55, Springer-Verlag, Berlin and New York, 1984, pp. 73–86.
- [Fife10] ———, *The singular perturbation approach to flame theory with chain and competing*

- reactions, Ordinary and Partial Differential Equations (Dundee, 1982), Lecture Notes in Math., vol. 964, Springer-Verlag, Berlin and New York, 1982, pp. 232–250.
- [Fife11] ———, *Flame fronts with complex chemical networks*, Phys. D **12** (1984), 182–197.
- [Fife12] ———, *Reduction methods in flame theory*, Nonlinear Systems of Partial Differential Equations in Applied Mathematics, Part 2 (Santa Fe, NM, 1984), Lectures in Appl. Math., vol. 23, Amer. Math. Soc., Providence, RI, 1986, pp. 314–329.
- [Fife13] P. C. Fife, *On modelling pattern formation by activator-inhibitor systems*, J. Math. Biol. **4** (1977), 353–362.
- [Fife14] ———, *Asymptotic analysis of reaction-diffusion wave fronts*, Rocky Mountain J. Math. **7** (1977), 389–415.
- [Fife15] ———, *Diffusive waves in inhomogeneous media*, Proc. Edinburgh Math. Soc. (2) **32** (1989), 291–315.
- [Fill1] A. K. Filonenko, *Spin-combustion, a new form of the propagation of a chemical reaction*, Arch. Termodyn. Spalania **6** (1975), no. 1, 25–36. (Russian)
- [Fil2] ———, *Nonsteady-state phenomena during combustion of heterogeneous systems forming refractory products*, Protsesty Goreninya v Khim. Teknol. i Metallurgii, Chernogolovka, 1975, pp. 274–283. (Russian)
- [Fil3] A. K. Filonenko and V. I. Vershinnikov, *Mechanism of spin burning of titanium in nitrogen*, Combust., Expl. and Shock Waves **11** (1975), 301–309.
- [Fir1] A. N. Firsov and K. G. Skadinskiĭ, *Nonstationary combustion regimes of gasless condensed substances periodically diluted by inert admixtures*, Combust., Expl. and Shock Waves **24** (1988), 726–730.
- [Fir2] ———, *Combustion of gasless compositions in the presence of heat losses*, Combust., Expl. and Shock Waves **23** (1987), 288–294.
- [Fis1] R. A. Fisher, *The wave of advance of advantageous genes*, Ann. Eugenics **7** (1937), 355–369.
- [Fra1] J. M. Fraile and J. Sabina, *Kinetic conditions for the existence of wave fronts in reaction-diffusion systems*, Proc. Roy. Soc. Edinburgh Sect. A **103** (1986), 161–177.
- [Fra2] ———, *Boundary value conditions for wave fronts in reaction-diffusion systems*, Proc. Roy. Soc. Edinburgh Sect. A **99** (1984), 127–136.
- [Fra3] ———, *General conditions for the existence of a “critical point-periodic wave front” connection for reaction-diffusion systems*, Nonlinear Anal. **13** (1989), 767–786.
- [Fran1] D. A. Frank-Kamenetskiĭ, *Diffusion and heat transfer in chemical kinetics*, Plenum Press, New York, 1969.
- [Fre1] M. I. Freidlin, *Propagation of a concentration wave in random motion conjugated with the growth of a substance*, Soviet Math. Dokl. **20** (1979), 503–507.
- [Fre2] ———, *Coupled reaction-diffusion equations*, Ann. Probab. **19** (1991), 29–57.
- [Fre3] ———, *Propagation of concentration waves in random motion conjugated with the substance growth*, Dokl. Akad. Nauk SSSR **246** (1979), no. 3, 544–548; English transl. in Soviet Math. Dokl. **20** (1979).
- [Fre4] ———, *On wave front propagation in multicomponent media*, Trans. Amer. Math. Soc. **276** (1983), 181–191.
- [Fri1] A. Friedman, *Partial differential equations*, Krieger, Huntington, NY, 1976.
- [Gal1] V. N. Galkina, V. I. Lubchenko, and G. N. Marchenko, *Propagation velocity of combustion wave in a condensed medium*, Dokl. Phys. Chem. **286** (1986), 43–47.
- [Garb1] M. Garbey, H. G. Kaper, G. K. Leaf, and B. J. Matkowsky, *Nonlinear analysis of condensed phase surface combustion*, European J. Appl. Math. **1** (1990), 73–89.
- [Garb2] ———, *Quasi-periodic waves and the transfer of stability in condensed phase surface combustion*, SIAM J. Appl. Math. **52** (1992), 384–395.
- [Garb3] ———, *Using MAPLE for the analysis of bifurcation phenomena in condensed-phase surface combustion*, J. Symbolic Comput. **12** (1991), 89–113.
- [Gard1] R. Gardner, *On the detonation of a combustible gas*, Trans. Amer. Math. Soc. **277** (1983), 431–468.
- [Gard2] ———, *Existence and stability of travelling wave solutions of competition models: a degree theoretic approach*, J. Differential Equations **44** (1982), 343–364.
- [Gard3] ———, *Existence of multidimensional travelling wave solutions of an initial-boundary value problem*, J. Differential Equations **61** (1986), 335–379.
- [Gard4] R. Gardner and J. Smoller, *The existence of periodic travelling waves for singularly perturbed predator-prey equations via the Conley index*, J. Differential Equations **47**

- (1983), 133–161.
- [Gard5] R. Gardner, *Existence of traveling wave solutions of predator–prey systems via the connection index*, SIAM J. Appl. Math. **44** (1984), 56–79.
- [Gard6] R. A. Gardner and C. K. R. T. Jones, *Traveling waves of a perturbed diffusion equation arising in a phase field model*, Indiana Univ. Math. J. **39** (1990), 1197–1222.
- [Gard7] ———, *Stability of traveling wave solutions of diffusive predator-prey systems*, Indiana Univ. Math. J. **39** (1990), 1197–1222.
- [Gard8] R. A. Gardner, *On the structure of the spectra of periodic travelling waves* (to appear).
- [Gard9] R. A. Gardner and C. K. R. T. Jones, *Stability of one-dimensional waves in weak and singular limits*, Viscous Profile and Numerical Methods for Shock Waves, SIAM, Philadelphia, PA, 1991, pp. 32–48.
- [Ger1] Yu. Gertner, *Nonlinear diffusion equations and excitable media*, Soviet Math. Dokl. **22** (1980), 571–574.
- [Ger2] Yu. Gertner and M. I. Freidlin, *The propagation of concentration waves in periodic and random media*, Soviet Math. Dokl. **20** (1979), 1282–1286.
- [Gib1] R. G. Gibbs, *Travelling waves in the Belousov-Zhabotinskiĭ reaction*, SIAM J. Appl. Math. **38** (1980), 422–444.
- [Gig1] Y. Giga and R. V. Kohn, *Nondegeneracy of blowup for semilinear heat equations*, Comm. Pure Appl. Math. **42** (1989), 845–884.
- [Gild1] B. H. Gilding and R. Kersner, *Diffusion-convection-réaction, frontières libres et une équation intégrale*, C. R. Acad. Sci. Paris Sér. I Math **313** (1991), 743–746.
- [Gils1] S. A. van Gils and J. Mallet-Paret, *Hopf bifurcation and symmetry: travelling and standing waves on the circle*, Proc. Roy. Soc. Edinburgh Sect. A **104** (1986), 279–307.
- [Gio1] V. Giovangigli, *Nonadiabatic plane laminar flames and their singular limits*, SIAM J. Math. Anal. **21** (1990), 1305–1325.
- [Gokh1] I. C. Gohberg and M. G. Kreĭn, *The basis propositions on defect numbers, root numbers and indices of linear operators*, Uspekhi Mat. Nauk **12** (1957), no. 2, 43–118; English transl. in Amer. Math. Soc. Transl. Ser. 2 **13** (1960).
- [Gom1] J. Gomatam and P. Grindrod, *Three-dimensional waves in excitable reaction-diffusion systems*, J. Math. Biol. **25** (1987), 611–622.
- [Goo1] J. Goodman, *Nonlinear asymptotic stability of viscous shock profiles for conservation laws*, Arch. Rational Mech. Anal. **95** (1986), 325–344.
- [Goo2] ———, *Stability of viscous scalar shock fronts in several dimensions*, Trans. Amer. Math. Soc. **311** (1989), 683–695.
- [Gray1] P. Gray, J. H. Merkin, D. J. Needham, and S. K. Scott, *The development of travelling waves in a simple isothermal chemical system. III. Cubic and mixed autocatalysis*, Proc. Roy. Soc. London Ser. A **430** (1990), 509–524.
- [Gray2] P. Gray and S. K. Scott, *Chemical oscillations and instabilities. Non-linear chemical kinetics*, Clarendon Press, Oxford, 1990.
- [Gre1] J. M. Greenberg, *Periodic solutions to reaction-diffusion equations*, SIAM J. Appl. Math. **30** (1976), 199–205.
- [Gre2] ———, *Axi-symmetric, time-periodic solutions of reaction-diffusion equations*, SIAM J. Appl. Math. **34** (1978), 391–397.
- [Gre3] ———, *Spiral waves for $\lambda - \omega$ systems*, SIAM J. Appl. Math. **39** (1980), 301–309.
- [Gre4] ———, *Spiral waves for $\lambda - \omega$ systems. II*, Adv. in Appl. Math. **2** (1981), 450–454.
- [Grin1] P. Grindrod and J. Gomatam, *The geometry and motion of reaction-diffusion waves on closed two-dimensional manifolds*, J. Math. Biol. **25** (1987), 597–610.
- [Grin2] P. Grindrod and B. D. Sleeman, *Weak travelling fronts for population models with density dependent dispersion*, Math. Methods Appl. Sci. **9** (1987), 576–586.
- [Grin3] P. Grindrod, *Patterns and waves*, Oxford Appl. Math. Comput. Sci. Ser., Oxford Univ. Press, New York, 1991.
- [Grin4] P. Grindrod, M. A. Lewis, and J. D. Murray, *A geometrical approach to wave-type solutions of excitable reaction-diffusion systems*, Proc. Roy. Soc. London Ser. A **433** (1991), 151–164.
- [Gris1] A. M. Grishin and E. E. Zelenskii, *Relaxational oscillations in combustion of gases and porous reacting systems*, Proceedings of the 4th Conference on Mathematics and Mechanics, Part 2, Tomsk. Gos. Univ., Tomsk, 1974, pp. 674–675. (Russian)

- [Gris2] ———, *Diffusional-thermal instability of the normal combustion of a three-component gas mixture*, *Combust., Expl. and Shock Waves* **24** (1988), 18–26.
- [Gus1] L. K. Gusachenko, V. E. Zarko, V. A. Zyryanov, and V. P. Bobryshev, *Modeling of combustion of solid fuels*, “Nauka”, Novosibirsk, 1985. (Russian)
- [Had1] K. P. Hadeler, *Nonlinear diffusion equations in biology*, *Ordinary and Partial Differential Equations*, Lecture Notes in Math., vol. 564, Springer-Verlag, Berlin, 1976, pp. 163–206.
- [Had2] K. P. Hadeler and F. Rothe, *Travelling fronts in nonlinear diffusion equations*, *J. Math. Biol.* **2** (1975), 251–263.
- [Had3] K. P. Hadeler, *Traveling front in parabolic and hyperbolic equations*, *Dynamical Systems*, Lecture Notes in Econom. and Math. Systems, vol. 287, Springer-Verlag, Berlin, 1987, pp. 154–164.
- [Hag1] P. S. Hagan, *The instability of nonmonotonic wave solutions of parabolic equations*, *Stud. Appl. Math.* **64** (1981), 57–88.
- [Hag2] ———, *Target patterns in reaction-diffusion systems*, *Adv. in Appl. Math.* **2** (1981), 400–416.
- [Hag3] ———, *Travelling wave and multiple travelling wave solutions of parabolic equations*, *SIAM J. Math. Anal.* **13** (1983), 717–738.
- [Hag4] ———, *Spiral waves in reaction-diffusion equations*, *SIAM J. Appl. Math.* **42** (1982), 762–786.
- [Har1] A. P. Hardt and P. V. Phung, *Propagation of gasless reactions in solids. I. Analytical study of exothermic intermetallic reaction rates*, *Combust. and Flame* **21** (1973), 77–89.
- [Her1] M. A. Herrero and J. L. Vazquez, *Thermal waves in absorbing media*, *J. Differential Equations* **74** (1988), 218–233.
- [Has1] S. P. Hastings, *The existence of periodic solutions to Nagumo’s equation*, *Quart. J. Math. Oxford Ser. (2)* **25** (1974), 369–378.
- [Has2] ———, *On the existence of homoclinic and periodic orbits for the FitzHugh-Nagumo equations*, *Quart. J. Math. Oxford Ser. (2)* **27** (1976), 123–134.
- [Has3] ———, *On travelling wave solutions of the Hodgkin-Huxley equations*, *Arch. Rational Mech. Anal.* **60** (1976), 229–257.
- [Has4] ———, *Single and multiple pulse waves for the FitzHugh-Nagumo equations*, *SIAM J. Appl. Math.* **42** (1982), 247–260.
- [Has5] S. P. Hastings, C. Lu, and Y. H. Wan, *Existence of a travelling flame front in a model with no cold boundary difficulty*, *SIAM J. Appl. Math.* **47** (1987), 1229–1249.
- [Hei1] S. Heinze, *Traveling waves in combustion processes with complex chemical networks*, *Trans. Amer. Math. Soc.* **304** (1987), 405–416.
- [Hei2] ———, *Traveling waves for semilinear parabolic partial differential equations in cylindrical domains*, Preprint No. 506, Heidelberg, 1989.
- [Hen1] D. Henry, *Geometric theory of semilinear parabolic equations*, *Lecture Notes in Math.*, vol. 840, Springer-Verlag, Berlin and New York, 1981.
- [Hil1] D. Hilhorst and J. Hulshof, *An elliptic-parabolic problem in combustion theory: convergence to travelling waves*, *Nonlinear Anal.* **17** (1991), 519–546.
- [Hil2] D. Hilhorst, E. Logak, and Y. Nishiura, *Singular limit for an Allen-Cahn equation with a nonlocal term* (to appear).
- [Hil3] D. Hilhorst and J. Hulshof, *A free boundary focusing problem*, Report No. W92-14, Mathematical Institute, University of Leiden, 1992.
- [How1] L. N. Howard and N. Kopell, *Wave trains, shock fronts, and transition layers in reaction-diffusion equations*, *Mathematical Aspects of Chemical and Biochemical Problems and Quantum Chemistry*, SIAM-AMS Proceedings, vol. 8, Amer. Math. Soc., Providence, RI, 1974, pp. 1–12.
- [How2] ———, *Slowly varying waves and shock structures in reaction-diffusion equations*, *Stud. Appl. Math.* **56** (1977), 95–145.
- [Hut1] V. C. L. Hutson and G. T. Vickers, *Travelling waves and dominance of ESS’s*, *J. Math. Biol.* **30** (1992), 451–471.
- [Ike1] H. Ikeda, M. Mimura, and Y. Nishiura, *Global bifurcation phenomena of travelling wave solutions for some bistable reaction diffusion systems*, *Nonlinear Anal.* **13** (1989), 507–526.
- [III] A. M. Il’in, *Matching of asymptotic expansions of solutions of boundary value*

- problems, "Nauka", Moscow, 1989; English transl., Transl. Math. Monographs, vol. 102, Amer. Math. Soc., Providence, RI, 1992.
- [Il2] A. M. Il'in and O. A. Oleinik, *Behavior of solutions of the Cauchy problem for certain quasilinear equations for unbounded increase of the time*, Dokl. Akad. Nauk SSSR **120** (1958), 25–28; English transl. in Amer. Math. Soc. Transl. Ser. 2 **42** (1964).
- [Il3] ———, *Asymptotic behavior of solutions of the Cauchy problem for some quasilinear equations for large values of the time*, Mat. Sb. **51** (1960), no. 2, 191–216. (Russian)
- [Il4] A. M. Il'in and S. I. Khudyaev, *On the asymptotics of stationary combustion wave in condensed medium*, Khimicheskaya Fizika **8** (1989), no. 4, 525–532; English transl. in Soviet J. Chem. Phys.
- [Iva1] G. R. Ivanitsky, V. I. Krinskiĭ, and E. E. Sel'kov, *Mathematical biophysics of cells*, "Nauka", Moscow, 1978. (Russian)
- [Ivl1] T. P. Ivleva, A. G. Merzhanov, and K. G. Skadinskiĭ, *Principles of the spin mode of combustion front propagation*, Combust., Expl. and Shock Waves **16** (1980), 133–139.
- [Ivl2] ———, *Mathematical model of spin combustion*, Soviet Phys. Dokl. **23** (1978), 255–256.
- [Ivl3] T. P. Ivleva and K. G. Skadinskiĭ, *On a regime of burning of a thin plate*, Fizika Goreniya i Vzryva **17** (1981), no. 1, 138–140. (Russian)
- [Ito1] M. Ito, *Travelling train solutions of FitzHugh-Nagumo systems*, Recent Topics in Nonlinear PDE III (Tokyo, 1986), North-Holland Math. Stud., vol. 148, North Holland, Amsterdam and New York, 1987, pp. 75–104.
- [Jon1] C. K. R. T. Jones, *Spherically symmetric solutions of a reaction-diffusion equation*, J. Differential Equations **49** (1983), 142–169.
- [Jon2] ———, *Asymptotic behaviour of a reaction-diffusion equation in higher space dimensions*, Rocky Mountain J. Math. **13** (1983), 355–364.
- [Jon3] ———, *Stability of the travelling wave solutions of the FitzHugh-Nagumo system*, Trans. Amer. Math. Soc. **286** (1984), 431–469.
- [Jon4] C. Jones, R. Gardner, and T. Kapitula, *Stability of travelling waves for non-convex scalar viscous conservation laws*, Comm. Pure Appl. Math. **46** (1993), 505–526.
- [Jou1] G. Joulin and P. Clavin, *Asymptotic analysis of a premixed laminar flame governed by a two-step reaction*, Combust. and Flame **23** (1975), 389–392.
- [Jou2] ———, *Asymptotic analysis of conditions of extinction for laminar flames*, Acta Astronautica **3** (1976), 223–240.
- [Jou3] ———, *Linear stability analysis of nonadiabatic flames: diffusional thermal model*, Combust. and Flame **35** (1979), 139–153.
- [Kag1] Z. I. Kaganova, *Secondary limit of isothermal flame propagation during decomposition of nitrogen chloride (NCl_3)*, Khimicheskaya Fizika **3** (1984), no. 3, 292–294; English transl. in Soviet J. Chem. Phys.
- [Kag2] ———, *Heterogeneous mechanism of isothermal flame propagation*, Khimicheskaya Fizika **3** (1984), no. 4, 598–602; English transl. in Soviet J. Chem. Phys.
- [Kag3] Z. I. Kaganova and B. V. Novozhilov, *Kinetics of branched chain reactions in the presence of an inhibitor*, Kinetics and Catalysis **21** (1980), 972–977.
- [Kag4] ———, *Inverse problem of the theory of combustion as exemplified by an isothermal flame of nitrogen trichloride decomposition*, Khimicheskaya Fizika **1** (1982), no. 8, 1110–1121; English transl. in Soviet J. Chem. Phys.
- [Kalan1] V. K. Kalantarov and O. A. Ladyzhenskaya, *Stabilization of solutions of a certain class of quasilinear parabolic equations as $t \rightarrow \infty$* , Siberian Math. J. **19** (1978), 737–744.
- [Kalen1] A. Kalen, *Thresholds and travelling waves in an epidemic model for rabies*, Nonlinear Anal. **8** (1984), 851–856.
- [Kam1] Y. Kametaka, *On the nonlinear diffusion equation of Kolmogorov-Petrovskiĭ-Piskunov type*, Osaka J. Math. **13** (1976), 11–66.
- [Kan1] Ya. I. Kanel', *The behavior of solutions of the Cauchy problem when the time tends to infinity, in the case of quasilinear equations arising in the theory of combustion*, Soviet Math. Dokl. **1** (1960), 533–536.
- [Kan2] ———, *Some problems involving burning-theory equations*, Soviet Math. Dokl. **2** (1961), 48–51.

- [Kan3] ———, *Stabilization of solutions of the Cauchy problem for equations encountered in combustion theory*, Mat. Sb. **101** (1962), 245–288. (Russian)
- [Kan4] ———, *The stationary solution of the set of equations in the theory of combustion*, Dokl. Phys. Chem. **149** (1963), 241–243.
- [Kan5] ———, *Stabilization of the solutions of the equations of combustion theory with finite initial functions*, Mat. Sb. **107** (1964), 398–413. (Russian)
- [Kan6] ———, *The existence of a solution of traveling wave type for the Belousov-Zhabotinskiĭ system of equations*, J. Differential Equations **26** (1990), 478–485.
- [Kan7] ———, *The existence of the solutions of traveling wave type for the Belousov-Zhabotinskiĭ system of equations. II*, Siberian Math. J. **32** (1992), 390–400.
- [Kant1] L. V. Kantorovich and G. P. Akilov, *Functional analysis*, “Nauka”, Moscow, 1977; English transl., Pergamon Press, Oxford, 1982.
- [Kapel] H. G. Kaper, G. K. Leaf, S. B. Margolis, and B. J. Matkowsky, *On nonadiabatic condensed phase combustion*, Combust. Sci. and Technol. **53** (1987), 289–314.
- [Kapi1] A. K. Kapila and G. S. Ludford, *Two-step sequential reactions for large activation energies*, Combust. and Flame **29** (1977), 167–176.
- [Kee1] J. P. Keener, *Waves in excitable media*, SIAM J. Appl. Math. **39** (1980), 528–548.
- [Kee2] ———, *A geometrical theory for spiral waves in excitable media*, SIAM J. Appl. Math. **46** (1986), 1039–1056.
- [Kern1] M. Kern, *On the stability and instability of autowaves of reaction-diffusion systems*, Math. Nachr. **141** (1989), 81–100.
- [Kha1] B. I. Khaikin, *Heterogeneous combustion*, Heat and Mass Transfer in Combustion Processes, Inst. Chem. Phys., Chernogolovka, 1980, pp. 58–79. (Russian)
- [Kha2] B. I. Khaikin and A. G. Merzhanov, *Theory of thermal propagation of a chemical reaction front*, Combust., Expl. and Shock Waves **2** (1966), 22–27.
- [Kha3] B. I. Khaikin, A. K. Filonenko, and S. I. Khudyaev, *Flame propagation in the presence of two successive gas-phase reactions*, Combust., Expl. and Shock Waves **4** (1968), 343–349.
- [Kha4] B. I. Khaikin and S. I. Khudyaev, *On nonuniqueness of stationary propagating reaction zones with competing reactions*, Preprint, Inst. Chem. Phys., Chernogolovka, 1978. (Russian)
- [Kha5] ———, *Nonuniqueness of combustion temperature and rate when competing reactions take place*, Dokl. Phys. Chem. **245** (1979), 225–228.
- [Kha6] B. I. Khaikin, S. I. Khudyaev, and L. A. Zhukova, *Nonuniqueness, stability and pulsating regimes of combustion with competing reactions*, Chemical Physics of the Processes of Combustion and Explosion. Combustion of Condensed and Heterogeneous Systems, Inst. Chem. Phys., Chernogolovka, 1980, pp. 28–32. (Russian)
- [Kha7] B. I. Khaikin and S. I. Khudyaev, *On nonuniqueness of stationary combustion waves*, Preprint, Inst. Chem. Phys., Chernogolovka, 1981. (Russian)
- [Kha8] B. I. Khaikin and K. G. Skadinskiĭ, *Effect of heat losses on propagation of the front of exothermal reaction in condensed phase*, Combustion and Explosion (Proc. III All-Union Symposium on Combustion and Explosion), “Nauka”, Moscow, 1972, pp. 24–29. (Russian)
- [Kha9] B. I. Khaikin and E. N. Rumanov, *Exothermic reaction regimes in a one-dimensional flow*, Combust., Expl. and Shock Waves **11** (1975), 573–579.
- [Khu1] S. I. Khudyaev, *Mathematical theory of combustion and explosion*, Preprint, Inst. Chem. Phys., Chernogolovka, 1980. (Russian)
- [Khu2] ———, *Asymptotic theory of stationary combustion waves*, Khimicheskaya Fizika **6** (1987), no. 5, 681–691; English transl. in Soviet J. Chem. Phys.
- [Kir1] K. Kirchgässner, *Wave solutions of reversible systems and applications*, J. Differential Equations **45** (1982), 113–127.
- [Kir2] ———, *Waves in weakly-coupled parabolic systems*, Nonlinear Analysis and Optimization, Lecture Notes in Math., vol. 1107, Springer-Verlag, Berlin and New York, 1984, pp. 154–180.
- [Kis1] O. V. Kiselev, and Yu. Sh. Matros, and N. A. Chumakova, *On propagation of the thermal front through the catalyst layer*, Propagation of Thermal Waves in Heterogeneous Media, “Nauka”, Novosibirsk, 1988, pp. 145–203. (Russian)
- [Kla1] G. A. Klaassen and W. C. Troy, *The stability of traveling wave front solution of a reaction-diffusion system*, SIAM J. Appl. Math. **41** (1981), 145–167.

- [Kla2] ———, *The asymptotic behavior of solutions of a system of reaction-diffusion equations which models the Belousov-Zhabotinskiĭ chemical reaction*, J. Differential Equations **40** (1981), 253–278.
- [Kla3] ———, *Stationary wave solutions of a system of reaction-diffusion equations derived from FitzHugh-Nagumo equations*, SIAM J. Appl. Math. **44** (1984), 96–110.
- [Koga1] S. Koga, *Rotating spiral waves in reaction-diffusion systems. Phase singularities of multi-armed waves*, Progr. Theoret. Phys. **67** (1982), 164–178.
- [Kole1] A. Yu. Kolesov, *A criterion for the stability of traveling waves of parabolic systems with small diffusion*, Siberian Math. J. **30** (1989), 484–488.
- [Kole2] Yu. S. Kolesov, *Stability and bifurcations of traveling waves*, Nonlinear Fluctuations in Problems of Ecology, Yaroslav. Gos. Univ., Yaroslavl', 1985, pp. 3–10. (Russian)
- [Kolm1] A. N. Kolmogorov, I. G. Petrovskii, and N. S. Piskunov, *Étude de l'équation de la chaleur avec croissance de la quantité de matière et son application à un problème biologique*, Bull. Moskov. Gos. Univ. Mat. Mekh. **1** (1937), no. 6, 1–25. (Russian)
- [Kon1] V. N. Kondrat'ev, *The mechanism of carbon disulfide oxidation*, Kinetics and Catalysis **13** (1972), 1223–1235.
- [Kop1] N. J. Kopell, *Waves, shocks and target patterns in an oscillating chemical reagent*, Nonlinear Diffusion, Res. Notes Math., No. 14, Pitman, London, 1977, pp. 129–154.
- [Kop2] ———, *Target pattern solutions to reaction-diffusion equations in the presence of impurities*, Adv. in Appl. Math. **2** (1981), 389–399.
- [Kop3] N. Kopell and L. N. Howard, *Plane wave solutions to reaction-diffusion equations*, Stud. Appl. Math. **52** (1973), 291–328.
- [Kop4] ———, *Bifurcations and trajectories joining critical points*, Adv. Math. **18** (1975), 306–358.
- [Kop5] ———, *Target patterns and horseshoes from perturbed central-force problems: some temporally periodic solutions to reaction-diffusion equations*, Stud. Appl. Math. **64** (1981), 1–56.
- [Kop6] ———, *Target patterns and spiral solutions to reaction-diffusion equations with more than one space dimension*, Adv. Appl. Math. **2** (1989), 417–449.
- [Kor1] H. F. Korman, *Theoretical modeling of cold flames*, Combust. Sci. and Technol. **2** (1970), 149–159.
- [Koro1] A. P. Korostelev and M. I. Freidlin, *On propagation of concentrational waves due to nonlinear boundary effects*, Factors of Variety in Mathematical Ecology and Population Genetics, Pushchino, 1980. (Russian)
- [Korob1] O. P. Korobeinichev (ed.), *Flame structure*, vol. 1–2, “Nauka”, Novosibirsk, 1991. (Russian)
- [Kra1] M. A. Krasnoselskiĭ, *Positive solutions of operator equations*, Noordhoff, Groningen, 1964.
- [Kra2] M. A. Krasnoselskiĭ and P. P. Zabreiko, *Geometrical methods of nonlinear analysis*, Grundlehren Math. Wiss. vol. 263, Springer-Verlag, Berlin and New York, 1984.
- [Kra3] M. A. Krasnoselskiĭ, P. P. Zabreiko, E. I. Pustyl'nik, and P. E. Sobolevskii, *Integral operators in spaces of summable functions*, Noordhoff, Leiden, 1976.
- [Kri1] V. I. Krinskiĭ, *Fibrillation in excitable media*, Problemi Kibernetiki **20** (1968), 59–80. (Russian)
- [Kri2] V. I. Krinskiĭ and K. I. Agladze, *Vortices with topological charge 2, 3, and 4 in an active chemical medium*, Soviet Phys. Dokl. **27** (1982), 228–229.
- [Kri3] V. I. Krinskiĭ, *Mathematical models of cardiac arrhythmias (spiral waves)*, Pharmac. Ther. B. **3** (1978), 539–555.
- [Kuz1] Yu. A. Kuznetsov, *Existence and stability of traveling waves for reaction diffusion systems in one dimension*, Preprint, NIVT, 1982. (Russian)
- [Lad1] O. A. Ladyzhenskaya and N. N. Ural'tseva, *Linear and quasilinear elliptic equations*, Academic Press, New York and London, 1968.
- [Lan1] P. S. Landa, *Self-oscillations in distributed systems*, “Nauka”, Moscow, 1983. (Russian)
- [Lar1] D. Larson, *On the stability of certain wave solutions to Nagumo's equation*, Quart. J. Math. Oxford Ser. (2) **28** (1977), 339–352.
- [Lar2] ———, *Transient bounds and time-asymptotic behaviour of solutions to nonlinear equations of Fisher type*, SIAM J. Appl. Math. **34** (1978), 93–103.

- [Ler1] J. Leray and J. Schauder, *Topologie et equations fonctionnelle*, Ann. Sci. École Norm. Sup. **113** (1934), 45–78.
- [Lev1] C. D. Levermore and J. X. Xin, *Multidimensional stability of traveling waves in a bistable reaction-diffusion equation*. II, Comm. Partial Differential Equations **17** (1992), 1901–1924.
- [Lew1] B. Lewis and G. von Elbe, *Combustion, flames and explosions of gases*, Academic Press, New York, San Francisco, and London, 1961.
- [Li1] Z. Y. Li, *The existence of traveling front solutions for reaction-diffusion system*, J. Partial Differential Equations **5** (1992), 17–22.
- [Li2] Z. Y. Li and Q. X. Ye, *Traveling wave front solutions for reaction-diffusion systems*, J. Partial Differential Equations **4** (1991), 1–14.
- [Liu1] Bao-Ping Liu and C. V. Pao, *Almost periodic plane wave solutions for reaction-diffusion equations*, J. Math. Anal. Appl. **105** (1985), 231–249.
- [Liu2] Bao-Ping Liu and Bi Zhao, *Multiple periodic plane wave solutions for the FitzHugh-Nagumo nerve conduction equations*, Acta Math. Appl. Sinica **12** (1989), 13–23.
- [Lua1] Ka-Sing Lua, *On the nonlinear diffusion equation of Kolmogorov, Petrovskii and Piskunov*, J. Differential Equations **59** (1985), 44–70.
- [Luk1] A. T. Luk'yanov, L. Yu. Artyukh, and P. G. Itskova, *Mathematical modeling of problems of combustion theory*, “Nauka”, Alma-Ata, 1981. (Russian)
- [Luk2] ———, *Resonance equilibrium in problems in combustion theory*, “Nauka”, Alma-Ata, 1989. (Russian)
- [Mag1] K. Maginu, *Stability of periodic travelling wave solutions of a nerve conduction equation*, J. Math. Biol. **6** (1978), 49–57.
- [Mag2] ———, *Existence and stability of periodic travelling wave solutions to Nagumo's nerve equation*, J. Math. Biol. **10** (1980), 133–153.
- [Mag3] ———, *Stability of periodic travelling wave solutions with large spatial periods in reaction-diffusion systems*, J. Differential Equations **39** (1981), 73–99.
- [Mag4] ———, *Geometrical characteristics associated with stability and bifurcations of periodic travelling waves in reaction-diffusion systems*, SIAM J. Appl. Math. **45** (1985), 750–774.
- [Makh1] G. M. Makhviladze and B. V. Novozhilov, *Two-dimensional stability of combustion of condensed systems*, Zh. Prikl. Mekh. i Tekhn. Fiz. (1971), no. 5, 51–59; English transl. in J. Appl. Mech. Tech. Phys.
- [Makh2] ———, *Two-dimensional combustion stability of condensed systems*, Heat Transfer – Soviet Research **5**, 37–44.
- [Mak1] E. I. Maksimov, A. G. Merzhanov, and V. M. Shkiro, *Gasless compositions as a simple model for the combustion of nonvolatile condensed systems*, Combust., Expl. and Shock Waves **1** (1965), 15–19.
- [Mak2] E. I. Maksimov and K. G. Skadinskiĭ, *Steady-state combustion stability gasless compositions*, Combust., Expl. and Shock Waves **7** (1971), 392–396.
- [Mak3] Yu. M. Maksimov, A. T. Pak, G. V. Lavrenchuk, Yu. S. Naiborodenko, and A. G. Merzhanov, *Spin combustion of gasless systems*, Combust., Expl. and Shock Waves **15** (1979), 415–418.
- [Mak4] Yu. M. Maksimov, A. G. Merzhanov, A. T. Pak, and M. N. Kuchkin, *Unstable combustion modes of gasless systems*, Combust., Expl. and Shock Waves **17** (1981), 393–400.
- [Mal1] B. A. Malomed, *Some modes for the propagation of auto-oscillatory waves*, Soviet Phys. Dokl. **26** (1981), 203–205.
- [Mar1] S. B. Margolis, *An asymptotic theory of condensed two-phase flame propagation*, SIAM J. Appl. Math. **43** (1983), 351–369.
- [Mar2] ———, *An asymptotic theory of heterogeneous condensed combustion*, Combust. Sci. and Technol. **43** (1985), 197–215.
- [Mar3] S. B. Margolis and R. M. Green, *Theoretical prediction of self-propagating, diffusion- and decomposition limited intermetallic reactions*, Combust. and Flame **34** (1979), 245–252.
- [Mar4] S. B. Margolis, H. G. Kaper, G. K. Leaf, and B. J. Matkowsky, *Bifurcation of pulsating and spinning reaction fronts in condensed two-phase combustion*, Combust. Sci. and Technol. **43** (1985), 127–165.

- [Mar5] S. B. Margolis and B. J. Matkowsky, *Flame propagation with a sequential reaction mechanism*, SIAM J. Appl. Math. **42** (1982), 1175–1188.
- [Mar6] ———, *Steady and pulsating model of sequential flame propagation*, Combust. Sci. and Technol. **27** (1982), 193–213.
- [Mar7] ———, *Nonlinear stability and bifurcation in the transition from laminar to turbulent flame propagation*, Combust. Sci. and Technol. **34** (1983), 45–77.
- [Mar8] ———, *Flame propagation in channels: secondary bifurcation to quasiperiodic pulsations*, SIAM J. Appl. Math. **45** (1985), 93–129.
- [Mar9] ———, *Flame propagation with multiple fuels*, SIAM J. Appl. Math. **42** (1982), 982–1003.
- [Mar10] ———, *New modes of quasiperiodic combustion near a degenerate Hopf bifurcation point*, SIAM J. Appl. Math. **48** (1988), 828–853.
- [Mars1] J. Marsden and M. McCracken, *The Hopf bifurcation and its applications*, Appl. Math. Sci., vol. 19, Springer-Verlag, New York, 1976.
- [Mas1] V. P. Maslov, V. G. Danilov, and K. A. Volosov, *Mathematical modeling of heat and mass-transport processes*, “Nauka”, Moscow, 1987. (Russian)
- [Mat1] B. J. Matkowsky and G. I. Sivashinsky, *Propagation of a pulsating reaction front in solid fuel combustion*, SIAM J. Appl. Math. **35** (1978), 465–478.
- [Mat2] ———, *An asymptotic derivation of two models in flame theory associated with the constant density approximation*, SIAM J. Appl. Math. **37** (1979), 686–699.
- [Mat3] B. J. Matkowsky and D. O. Olagunju, *Propagation of a pulsating flame front in a gaseous combustible mixture*, SIAM J. Appl. Math. **39** (1980), 290–300.
- [Mat4] ———, *Pulsations in a burner stabilized premixed plane flame*, SIAM J. Appl. Math. **40** (1981), 551–562.
- [Mat5] ———, *Traveling waves along the front of a pulsating flame*, SIAM J. Appl. Math. **42** (1982), 486–501.
- [Mat6] ———, *Spinning waves in gaseous combustion*, SIAM J. Appl. Math. **42** (1982), 1138–1156.
- [Mat7] B. J. Matkowsky and G. I. Sivashinsky, *On oscillatory necking in polymers*, Quart. Appl. Math. **37** (1979), 23–34.
- [McK1] H. P. McKean, *Application of Brownian motion to the equation of Kolmogorov-Petrovskii-Piskunov*, Comm. Pure Appl. Math. **28** (1975), 323–331; *A correction to: “Application of Brownian motion to the equation of Kolmogorov-Petrovskii-Piskunov”*, Comm. Pure Appl. Math. **29** (1976), 553–554.
- [McK2] ———, *Stabilization of solutions of a caricature of the FitzHugh-Nagumo equation. II*, Comm. Pure Appl. Math. **37** (1984), 299–301.
- [Meg1] I. N. Megrabova, Vit. A. Volpert, Vl. A. Volpert, and S. P. Davtyan, *Two-dimensional chemical reaction regimes in a flow*, Dokl. Phys. Chem. **307** (1989), 618–620.
- [Meg2] ———, *Two-dimensional combustion conditions in flow*, Combust., Expl. and Shock Waves **26** (1990), 413–417.
- [Mer1] A. G. Merzhanov, *Theory of gasless combustion*, Archiwum Procesow Spalania **5** (1974), no. 1, 17–39. (Russian)
- [Mer2] ———, *Self-propagating high-temperature synthesis*, Physical Chemistry. Present-Day Problems, Khimiya, Moscow, 1983, pp. 5–45. (Russian)
- [Mer3] ———, *New elementary combustion models of the second kind*, Dokl. Phys. Chem. **233** (1977), 430–434.
- [Mer4] A. G. Merzhanov, I. P. Borovinskaya, and V. M. Shkuro, *Synthesis of refractory inorganic compounds*, Patent Certif. 255221, Appl. No. 1170735, 1967.
- [Mer5] A. G. Merzhanov, A. V. Dvoryankin, and A. G. Strunina, *New type of spin burning*, Dokl. Phys. Chem. **267** (1983), 979–981.
- [Mer6] A. G. Merzhanov, E. N. Rumanov, and B. I. Khaikin, *Multizone burning of condensed systems*, Zh. Prikl. Mekh. i Tekhn. Fiz. (1972), no. 6, 99–105; English transl. in J. Appl. Mech. Tech. Phys.
- [Mer7] A. G. Merzhanov, A. K. Filonenko, and I. P. Borovinskaya, *New phenomena in combustion of condensed systems*, Dokl. Phys. Chem. **208** (1973), 122–125.
- [Mer8] A. G. Merzhanov and B. I. Khaikin, *Theory of combustion waves in homogeneous media*, Progr. Energy Combust. Sci. **14** (1988), 1–98.
- [Mer9] A. G. Merzhanov and A. K. Filonenko, *Thermal self-ignition of a homogeneous gas mixture in a stream*, Dokl. Phys. Chem. **152** (1963), 769–772.

- [Mim1] M. Mimura, *Wave propagation and its failure in bistable reaction-diffusion systems*, Nonlinear Analysis, World Sci. Publishing, Teaneck, NJ, 1991, pp. 185–222.
- [Mis1] K. Mischaikow, *Traveling waves for a cooperative and competitive-cooperative system*, Viscous Profiles and Numerical Methods for Shock Waves, SIAM, Philadelphia, PA, 1991, pp. 125–141.
- [Moe1] H. J. Moet, *A note on the asymptotic behavior of solutions of the KPP equation*, SIAM J. Math. Anal. **10** (1979), 728–732.
- [Mot1] P. de Mottoni and M. Schatzman, *Geometrical evolution of interfaces*, C.R. Acad. Sci. Paris Sér. I Math. **309** (1989), 453–458.
- [Mot2] ———, *Development of interfaces in R^n* , Proc. Roy. Soc. Edinburgh Sect. A **116** (1990), 207–220.
- [Mot3] ———, *Geometrical evolution of developed interfaces*, Trans. Amer. Math. Soc. (to appear).
- [Mot4] ———, *Asymptotics of the Fauve-Thual pulse*, Asymptotic and Numerical Methods for Partial Differential Equations with Critical Parameters (M. Garbey and H. Kaper, eds.), Kluwer, Boston, 1992, pp. 225–239.
- [Mot5] ———, *Existence and stability of Thual-Fauve pulse*, Preprint No. 148, CNRS URA 740, 1993.
- [Mur1] J. D. Murray, *Nonlinear differential equation models in biology*, Clarendon Press, Oxford, 1977.
- [Nan1] P. J. Nandapurkar and A. T. Winfree, *Dynamical stability of untwisted scroll rings in excitable media*, Phys. D **35** (1989), 277–288.
- [Nek1] E. A. Nekrasov and A. M. Timokhin, *Nonuniqueness of steady combustion conditions in a sequential reactions with an endothermic stage*, Combust., Expl. and Shock Waves **20** (1984), 256–261.
- [Nek2] ———, *Theory of multistage combustion with an endothermic reaction*, Combust., Expl. and Shock Waves **20** (1984), 377–383.
- [Nek3] ———, *Theory of thermal wave propagation of multistage reactions described by simple empirical schemes*, Combust., Expl. and Shock Waves **22** (1986), 431–437.
- [Nir1] L. Nirenberg, *On elliptic partial differential equations*, Ann. Scuola Norm. Sup. Pisa Cl. Sci. (3) **13** (1959), 115–162.
- [Nis1] Y. Nishiura, M. Mimura, H. Ikeda, and H. Fujii, *Singular limit analysis of stability of traveling wave solutions in bistable reaction-diffusion systems*, SIAM J. Math. Anal. **21** (1990), 85–122.
- [Nis2] Y. Nishiura, *Singular limit approach to stability and bifurcation for bistable reaction diffusion systems.*, Rocky Mountain J. Math. **21** (1991), 727–767.
- [Non1] A. V. Gaponov-Grekhov and M. I. Rabinovich (eds.), *Nonlinear waves, structures and bifurcations*, “Nauka”, Moscow, 1987. (Russian)
- [Non2] ———, *Nonlinear waves, dynamics and evolution*, “Nauka”, Moscow, 1989; English transl., A. V. Gaponov-Grekhov, M. I. Rabinovich, and J. Engelbrecht (eds.), Springer-Verlag, Berlin and New York, 1989.
- [Nor1] J. Norbury and A. M. Stuart, *Travelling combustion waves in a porous medium. I. Existence*, SIAM J. Appl. Math. **48** (1988), 155–169.
- [Nor2] ———, *Travelling combustion waves in a porous medium. II. Stability*, SIAM J. Appl. Math. **48** (1988), 374–392.
- [Nov1] B. V. Novozhilov, *The rate of propagation of the front of an exothermic reaction in a condensed phase*, Dokl. Phys. Chem. **141** (1961), 836–838.
- [Nov2] ———, *Nonsteady-state combustion of solid rocket fuels*, “Nauka”, Moscow, 1973. (Russian)
- [Nov3] B. V. Novozhilov and V. S. Posvyansky, *Propagation velocity of a cold flame*, Combust., Expl. and Shock Waves **9** (1973), 191–194.
- [Nov4] ———, *Verification of the method of quasistationary concentrations in the problem of cold-flame propagation*, Combust., Expl. and Shock Waves **10** (1974), 81–86.
- [Oli1] L. A. F. De Olivera, *Existence of traveling waves in the FitzHugh-Nagumo equation*, Dynamic Systems Appl. **1** (1992), 83–93.
- [Ort1] P. Ortoleva, *Dynamic Pade approximant and behavior singularities in nonlinear physico-chemical systems*, Bifurcations and Nonlinear Eigenvalue Problems, Lecture Notes in Math., vol. 782, Springer-Verlag, Berlin, 1980, pp. 255–264.

- [Oth1] H. Othmer, *Nonlinear wave propagation in reacting systems*, J. Math. Biol. **2** (1975), 133–163.
- [Pab1] A. de Pablo and J. L. Vazquez, *Traveling waves and finite propagation in a reaction-diffusion equation*, J. Differential Equations **93** (1991), 16–61.
- [Pap1] G. Papanicolaou and X. Xin, *Reaction-diffusion fronts in periodically layered media*, J. Statist. Phys. **63** (1991), 915–931.
- [Pel1] J. Peláez and A. Linan, *Structure and stability of flame with two sequential reactions*, SIAM J. Appl. Math. **45** (1985), 503–522.
- [Pel2] J. Peláez, *Stability of two premixed flames with two thin reaction layers*, SIAM J. Appl. Math. **47** (1987), 781–799.
- [Pelc1] P. Pelce and J. Sun, *Stability of spiral waves in the large-hole-radius limit*, Phys. Rev. A **44** (1991), R7906–R7909.
- [Pim1] G. H. Pimbley, *Wave solutions travelling along quadratic paths for the equation $(\partial u/\partial t) - (K(u)u_x)_x = 0$* , Quart. Appl. Math. **35** (1977), 129–138.
- [Pli1] V. A. Pliss, *Integral sets of periodic systems of differential equations*, “Nauka”, Moscow, 1977. (Russian)
- [Pro1] Yu. Sh. Matros (ed.), *Propagation of thermal waves in heterogeneous media*, “Nauka”, Novosibirsk, 1988. (Russian)
- [Pus1] J. Puszynski, J. Degreve, and V. Hlaváček, *Modeling of exothermic solid-solid noncatalytic reactions*, Indust. Eng. Chem. Res. **26** (1987), 1424–1434.
- [Rab1] M. I. Rabinovich and D. I. Trubetskoy, *Introduction to the theory of oscillations and waves*, “Nauka”, Moscow, 1984; English transl., *Oscillations and waves in linear and nonlinear systems*, Math. Appl. (Soviet Ser.), vol. 50, Kluwer, Dordrecht, 1989.
- [Rad1] S. P. Radev and S. B. Scherbak, *Unstable combustion of a cylindrical sample with a gas-free composition*, C. R. Acad. Bulgare Sci. **35** (1982), 475–478.
- [Rau1] J. Rauch and J. Smoller, *Qualitative theory of the FitzHugh-Nagumo equations*, Adv. Math. **27** (1978), 12–44.
- [Red1] R. Redheffer and W. Walter, *Invariant sets for systems of partial differential equations. I. Parabolic equations*, Arch. Rational Mech. Anal. **67** (1978), 41–52.
- [Rein1] J. F. Reineck, *Travelling wave solutions to a gradient systems*, Trans. Amer. Math. Soc. **307** (1988), 535–544.
- [Reiss1] E. L. Reiss, *Cascading bifurcations*, SIAM J. Appl. Math. **43** (1983), 57–65.
- [Ren1] M. Renardy, *Bifurcation from rotating waves*, Arch. Rational Mech. Anal. **79** (1982), 49–84.
- [Rin1] J. Rinzel, *Spatial stability of travelling wave solutions of a nerve conduction equation*, Biophys. J. **15** (1975), 975–988.
- [Rin2] ———, *Neutrally stable traveling wave solutions of nerve conduction equations*, J. Math. Biol. **2** (1975), 205–217.
- [Rin3] ———, *Nerve signaling and spatial stability of wave trains*, Lecture Notes in Math., vol. 525, Springer-Verlag, Berlin and New York, 1976, pp. 127–142.
- [Rin4] J. Rinzel and J. B. Keller, *Travelling wave solutions of a nerve conduction equation*, Biophys. J. **13** (1973), 1313–1337.
- [Rom1] Yu. M. Romanovskii, N. V. Stepanova, and D. S. Chernavskii, *Mathematical simulation in biophysics*, “Nauka”, Moscow, 1975. (Russian)
- [Rom2] ———, *Mathematical biophysics*, “Nauka”, Moscow, 1984. (Russian)
- [Roq1] J. M. Roquejoffre, *Stability of travelling fronts in a model for flame propagation. Part II: Nonlinear stability*, Arch. Rational Mech. Anal. **117** (1992), 119–153.
- [Roq2] ———, *Convergence to travelling waves for solutions of a class of semilinear parabolic equations*, Preprint No. 236, Centre Math. Appl., Ecole Polyt., Palaiseau, 1991.
- [Roq3] J. F. Mallordy and J. M. Roquejoffre, *A parabolic equation of KPP type in higher dimensions*, Preprint No. 262, Centre Math. Appl., Ecole Polyt., Palaiseau, 1992.
- [Ros1] G. Rosen, *An action principle for the laminar flame*, VII International Symposium on Combustion, Butterworths Scientific Publications, London, 1959, pp. 339–341.
- [Ros2] ———, *Generalization of the laminar flame action principle for Arrhenius-type rate functions*, J. Chem. Phys. **32** (1960), 311–312.
- [Rot1] F. Rothe, *Convergence to travelling fronts in semilinear parabolic equations*, Proc. Roy. Soc. Edinburgh Sect. A **80** (1978), 213–234.
- [Rot2] ———, *Convergence to pushed fronts*, Rocky Mountain J. Math. **11** (1981), 617–633.

- [Roy1] V. Roytburd, *A Hopf bifurcation for a reaction-diffusion equation with concentrated chemical kinetics*, J. Differential Equations **56** (1985), 40–62.
- [Ryb1] S. S. Rybanin and S. L. Sobolev, *Velocity and combustion limits in a thermally thin condensed substance layer undergoing heat exchange with an inert medium*, Combust., Expl. and Shock Waves **25** (1989), 524–531.
- [Ryb2] ———, *Critical conditions of combustion of macroheterogeneous systems consisting of a fuel and an inert material*, Dokl. Phys. Chem. **269** (1983), 276–279.
- [Ryb3] ———, *Velocity and limits of combustion of a thermally thick condensed substance layer exchanging heat with an inert medium*, Combust., Expl. and Shock Waves **25** (1989), 531–540.
- [Sab1] J. Sabina, *Directional wave fronts of reaction diffusion systems*, Bull. Austral. Math. Soc. **33** (1986), 1–20.
- [Sam1] A. A. Samarskiĭ, V. A. Galaktionov, S. P. Kurdyumov, and A. P. Mikhaĭlov, *Peaking modes in problems for quasilinear parabolic equations*, “Nauka”, Moscow, 1987. (Russian)
- [Sat1] D. H. Sattinger, *On the stability of waves of nonlinear parabolic systems*, Adv. Math. **22** (1976), 312–355.
- [Sat2] ———, *Weighted norms for the stability of traveling waves*, J. Differential Equations **25** (1977), 130–144.
- [Sat3] ———, *Group theoretic methods in bifurcation theory*, Lecture Notes in Math., vol. 762, Springer-Verlag, Berlin and New York, 1980.
- [Sch1] S. B. Scherbak, *Unstable combustion of samples of gas-free compositions in the form of rods of square and circular cross section*, Combust., Expl. and Shock Waves **19** (1983), 542–545.
- [Sch2] ———, *Spatial modes of unstable combustion of a specimen of gasless composition in the form of a long rod of square section*, Combust., Expl. and Shock Waves **20** (1984), 145–149.
- [Schon] M. E. Schonbek, *Boundary value problems for the FitzHugh-Nagumo equations*, J. Differential Equations **30** (1978), 119–147.
- [Sco1] A. Scott, *Active and nonlinear wave propagation in electronics*, Wiley-Interscience, New York, 1970.
- [Sco2] S. K. Scott, *Chemical chaos*, Clarendon Press, Oxford, 1991.
- [Sem1] N. N. Semenov, *Chain reactions*, “Nauka”, Moscow, 1986. (Russian)
- [Sem2] ———, *Chemical kinetics and chain reactions*, Clarendon Press, Oxford, 1935.
- [Sem3] ———, *Thermal theory of combustion and explosion*, Uspekhi Fiz. Nauk **23** (1940), 251–292. (Russian)
- [Sem4] ———, *Theory of the normal propagation of flames*, Uspekhi Fiz. Nauk **24** (1940), 433–486. (Russian)
- [Sem5] ———, *Theory of homogeneous combustion of homogeneous gas systems*, Izvest. Akad. Nauk SSSR, Otdel. Tekh. Nauk (1953), 708–729. (Russian)
- [Scha1] M. Schatzman, *On the stability of the saddle solution of Allen – Cahn’s equation*, Preprint No. 151, CNRS URA 740, 1993.
- [Shi1] N. Shigesada, K. Kawasaki, and E. Teramoto, *Traveling periodic waves in heterogeneous environments*, Theoret. Population Biol. **30** (1986), 143–160.
- [Shk1] K. G. Skadinskiĭ, V. V. Barelko, and I. I. Kurochka, *Set of solutions in the form of traveling waves for the combustion type equation*, Dokl. Phys. Chem. **233** (1977), 377–379.
- [Shk2] K. G. Skadinskiĭ and M. I. Lebedeva, *Stationary flame propagation in a heterogeneous solid in the presence of heat loss*, Combust., Expl. and Shock Waves **11** (1975), 448–454.
- [Shk3] K. G. Skadinskiĭ, B. I. Khaikin, and A. G. Merzhanov, *Propagation of a pulsating exothermic reaction front in the condensed phase*, Combust., Expl. and Shock Waves **7** (1971), 15–22.
- [Siv1] G. I. Sivashinsky, *Diffusional-thermal theory of cellular flames*, Combust. Sci. and Technol. **15** (1977), 137–146.
- [Siv2] ———, *On spinning propagation of combustion waves*, SIAM J. Appl. Math. **40** (1981), 432–438.
- [Siv3] ———, *Instabilities, pattern formation, and turbulence in flames*, Ann. Rev. Fluid Mech. **15** (1983), 179–199.

- [Siv4] ———, *On flame propagation under conditions of stoichiometry*, SIAM J. Appl. Math. **39** (1980), 67–82.
- [Siv5] G. I. Sivashinsky and S. B. Margolis, *Some new solutions of the flame front equation*, Numerical Simulation of Combustion Phenomena (Sophia-Antipolis, 1985), Lecture Notes in Phys., vol. 241, Springer-Verlag, Berlin and New York, 1985, pp. 131–136.
- [Skr1] I. V. Skrypnik, *Nonlinear elliptic boundary value problems*, Teubner-Texte Math., vol. 91, Teubner, Leipzig, 1986.
- [Sle1] B. D. Sleeman and E. Tuma, *On exact solution of a class of reaction-diffusion equations*, IMA J. Appl. Math. **33** (1984), 153–168.
- [Sle2] B. D. Sleeman, *Small amplitude periodic waves for the FitzHugh-Nagumo equations*, J. Math. Biol. **14** (1982), 309–325.
- [Smol1] J. A. Smoller, *Shock waves and reaction in diffusion equation*, Grundlehren Math. Wiss., vol. 258, Springer-Verlag, Berlin and New York, 1983.
- [Soh1] S. A. Sohrab and B. A. Chao, *Influences of upstream versus downstream heat loss/gain on stability of premixed flames*, Combust. Sci. and Technol. **38** (1984), 245–265.
- [Spal1] D. B. Spalding, *A theory of inflammability limits and flame quenching*, Proc. Roy. Soc. London Ser. A **240** (1957), 83–100.
- [Sto1] A. N. Stokes, *On two types of moving front in quasilinear diffusion*, Math. Biosci. **31** (1976), 307–315.
- [Sto2] ———, *Nonlinear diffusion waveshapes generated by possibly finite initial disturbances*, J. Math. Anal. Appl. **61** (1977), 370–381.
- [Str1] V. A. Strunin, A. N. Firsov, K. G. Skadinskiĭ, and G. B. Manelis, *Combustion characteristics of a heterogeneous layered system*, Combust., Expl. and Shock Waves **25** (1989), 540–546.
- [Str2] A. G. Strunina and A. V. Dvoryankin, *Effect of thermal factors on the mechanism of unstable combustion*, Dokl. Phys. Chem. **260** (1981), 954–957.
- [Str3] A. G. Strunina, A. V. Dvoryankin, and A. G. Merzhanov, *Unstable regimes of thermite system combustion*, Combust., Expl. and Shock Waves **19** (1983), 158–163.
- [Str4] A. G. Strunina, L. K. Demidova, A. N. Firsov, and A. G. Merzhanov, *Stability of gasless system combustion in the presence of heat losses*, Combust., Expl. and Shock Waves **23** (1987), 294–299.
- [Svi1] Yu. M. Svirezhev and V. P. Pasekov, *Foundations of mathematical genetics*, “Nauka”, Moscow, 1982. (Russian)
- [Svi2] Yu. M. Svirezhev, *Nonlinear waves, dissipative structures and catastrophes in ecology*, “Nauka”, Moscow, 1987. (Russian)
- [Tali1] S. D. Taliaferro, *Stability and bifurcations of traveling wave solutions of nerve axon type equations*, J. Math. Anal. and Appl. **137** (1989), 396–416.
- [Tan1] M. M. Tang and P. C. Fife, *Propagating fronts for competing species equations with diffusion*, Arch. Rational Mech. Anal. **73** (1980), 69–77.
- [Ter1] D. Terman, *Directed graphs and traveling waves*, Trans. Amer. Math. Soc. **289** (1985), 809–847.
- [Ter2] ———, *Propagation phenomena in the FitzHugh-Nagumo equations*, Delft. Progr. Rep. **10** (1985), 67–73.
- [Ter3] ———, *Infinitely many traveling wave solutions of a gradient system*, Trans. Amer. Math. Soc. **301** (1987), 537–556.
- [Ter4] ———, *Travelling wave solutions of a gradient system: solutions with a prescribed winding number. I*, Trans. Amer. Math. Soc. **308** (1988), 369–389.
- [Ter5] ———, *Stability of planar wave solutions to a combustion model*, SIAM J. Math. Anal. **21** (1990), 1139–1171.
- [Ter6] ———, *Traveling wave solutions arising from a two-step combustion model*, SIAM J. Math. Anal. **19** (1988), 1057–1080.
- [Ter7] ———, *Wave propagation in two chemical systems*, Rend. Sem. Mat. Univ. Politec. Torino, Special Issue, 1989, pp. 145–157.
- [Thi1] J. J. Thiert, H. J. Viljoen, N. F. J. van Rensburg, J. E. Gatica, and V. Hlaváček, *Stability of nonadiabatic solid-solid combustion*, Combust. Sci. and Technol. **82** (1992), 185–204.
- [Troy1] W. C. Troy, *The bifurcation of periodic solutions in the Hodgkin-Huxley equations*, Quart. Appl. Math. **36** (1978), 73–83.

- [Troy2] ———, *The existence of travelling wave front solutions of a model of the Belousov-Zhabotinskiĭ chemical reaction*, J. Differential Equations **36** (1980), 89–98.
- [Tys1] J. Tyson and P. Fife, *Target patterns in a realistic model of the Belousov-Zhabotinskiĭ reaction*, J. Chem. Phys. **73** (1980), 2224–2237.
- [Tys2] J. J. Tyson and J. P. Keener, *Singular perturbation theory of traveling waves in excitable media*, Phys. D **32** (1988), 327–361.
- [Uch1] K. Uchiyama, *The behaviour of solutions of the equation of Kolmogorov-Petrovskiĭ-Piskunov*, Proc. Japan. Acad. Ser. A Math. Sci. **53** (1977), 225–228.
- [Uch2] ———, *The behavior of solutions of some nonlinear diffusion equations for large time*, J. Math. Kyoto Univ. **18** (1978), 453–508.
- [Uch3] ———, *Asymptotic behavior of solutions of reaction-diffusion equations with varying drift coefficients*, Arch. Rational Mech. Anal. **90** (1985), 291–311.
- [Vag1] D. A. Vaganov and S. I. Khudyaev, *Stationary problem of the theory of combustion*, Combust., Expl. and Shock Waves **5** (1969), 114–117.
- [Vas1] V. A. Vasilev, Yu. M. Romanovskiĭ, and V. G. Yakhno, *Autowave processes in distributed kinetic systems*, Soviet Phys. Uspekhi **22** (1979), 615–639.
- [Vas2] ———, *Autowave processes*, “Nauka”, Moscow, 1987; English transl., V. M. Vasiliev, Yu. M. Romanovskiĭ, D. S. Chernavskiĭ, and V. G. Yakhno, *Autowave processes in kinetic systems*, Math. Appl. (Soviet Ser.), vol. 11, Reidel, Dordrecht and Boston, 1987.
- [Vel1] E. J. M. Veling, *Convergence to a traveling wave in an initial-boundary problem*, Ordinary and Partial Differential Equations (Dundee, 1980), Lecture Notes in Math., vol. 856, Springer-Verlag, Berlin, 1981, pp. 366–372.
- [Vel2] ———, *Travelling waves in an initial-boundary value problem*, Proc. Roy. Soc. Edinburgh Sect. A **90** (1981), 41–61.
- [Volos1] K. A. Volosov, V. G. Danilov, N. A. Kolobov, and V. P. Maslov, *Solutions of localized solitary wave type for quasilinear parabolic diffusion equations with chemical reactions*, Soviet Math. Dokl. **33** (1986), 517–521.
- [Vol1] A. I. Volpert, *Qualitative methods of investigation of equations of chemical kinetics*, Preprint, Inst. Chem. Phys., Chernogolovka, 1976. (Russian)
- [Vol2] ———, *Asymptotic behavior of solutions of nonlinear diffusion equations*, Boundary Value Problems of Mathematical Physics, “Naukova Dumka”, Kiev, 1981, pp. 13–17. (Russian)
- [Vol3] ———, *Application of functionals to investigation of traveling waves*, Operator Equations and Set Functions, Perm. Gos. Univ., Syktyvkar, 1985, pp. 30–35. (Russian)
- [Vol4] A. I. Volpert and V. A. Volpert, *Bifurcation of waves described by parabolic systems*, General Theory of Boundary Value Problems, “Naukova Dumka”, Kiev, 1983, pp. 43–49. (Russian)
- [Vol5] ———, *Estimates of operators describing traveling waves and their application to construction of the rotation of vector fields*, Preprint, Inst. Chem. Phys., Chernogolovka, 1985. (Russian)
- [Vol6] ———, *Applications of the rotation theory of vector fields to the study of wave solutions of parabolic equations*, Trans. Moscow Math. Soc. **52** (1990), 59–108.
- [Vol7] ———, *Traveling waves described by monotone parabolic systems*, Preprint, Inst. Chem. Phys., Chernogolovka, 1990. (Russian)
- [Vol8] ———, *Construction of the rotation of a vector field for operators describing wave solutions of parabolic systems*, Soviet Math. Dokl. **36** (1988), 452–455.
- [Vol9] A. I. Volpert and S. I. Khudyaev, *Analysis in classes of discontinuous functions and equations of mathematical physics*, “Nauka”, Moscow, 1975; English transl., Nijhoff, Dordrecht, 1985.
- [Vol10] V. A. Volpert, *The spectrum of an elliptic operator in an unbounded cylindrical domain*, Dokl. Akad. Nauk Ukrain. SSR Ser. A **1981**, no. 9, 9–12. (Russian)
- [Vol11] ———, *Stability problems for traveling wave solutions*, Preprint, Inst. Chem. Phys., Chernogolovka, 1980. (Russian)
- [Vol12] ———, *On the spectrum of an elliptic operator in an unbounded cylindrical domain and some applications to the stability of traveling waves*, Boundary Value Problems of Mathematical Physics (Ya. B. Lopatinskiĭ, ed.), “Naukova Dumka”, Kiev, 1981, pp. 17–19. (Russian)

- [Vol13] ———, *Bifurcation of nonstationary combustion modes*, Preprint, Inst. Chem. Phys., Chernogolovka, 1982. (Russian)
- [Vol14] ———, *Asymptotic behavior of solutions of nonlinear diffusion equations with positive source-function*, Preprint, Inst. Chem. Phys., Chernogolovka, 1983. (Russian)
- [Vol15] ———, *Asymptotic behavior of solutions of a nonlinear diffusion equation*, Preprint, Inst. Chem. Phys., Chernogolovka, 1983. (Russian)
- [Vol16] ———, *The approach of solutions of a nonlinear diffusion equation to traveling waves*, Preprint, Inst. Chem. Phys., Chernogolovka, 1984. (Russian)
- [Vol17] ———, *Stability of combustion in flow*, *Combust., Expl. and Shock Waves* **23** (1987), 320–324.
- [Vol18] ———, *Asymptotic behavior of solutions of a nonlinear diffusion equation with a source term of general form*, *Siberian Math. J.* **30** (1989), 25–36.
- [Vol19] ———, *Convergence to a wave of solutions of a nonlinear diffusion equation with source of general form*, *Siberian Math. J.* **30** (1989), 203–210.
- [Vol20] V. A. Volpert and R. A. Barzykina, *Theory of combustion waves for SHS-processes*, Preprint, Inst. Struct. Macrokinetics, Chernogolovka, 1988. (Russian)
- [Vol21] V. A. Volpert and A. I. Volpert, *Bifurcations of waves described by parabolic systems*, *General Theory of Boundary Value Problems* (Ya. B. Lopatinskiĭ, ed.), “Naukova Dumka”, Kiev, 1983, pp. 43–49. (Russian)
- [Vol22] ———, *Application of the Leray-Schauder method to the proof of the existence of wave solutions of parabolic systems*, *Soviet Math. Dokl.* **37** (1988), 138–141.
- [Vol23] ———, *Existence and stability of traveling waves in chemical kinetics*, *Dynamics of Chemical and Biological Systems*, “Nauka”, Novosibirsk, 1989, pp. 56–131. (Russian)
- [Vol24] ———, *Waves of chemical transformation having complex kinetics*, *Dokl. Phys. Chem.* **309** (1989), 877–879.
- [Vol25] ———, *Existence and stability of waves in chemical kinetics*, *Khimicheskaya Fizika* **9** (1990), no. 2, 238–245; English transl. in *Soviet J. Chem. Phys.*
- [Vol26] ———, *Some mathematical problems of wave propagation in chemical active media*, *Khimicheskaya Fizika* **9** (1990), no. 8, 1118–1127; English transl. in *Soviet J. Chem. Phys.*
- [Vol27] ———, *Some problems of multidimensional wave propagation in chemical kinetics* (to appear).
- [Vol28] Vit. A. Volpert and Vl. A. Volpert, *Determinating the asymptotics of the velocity of a combustion wave using successive approximations*, *J. Appl. Mech. Tech. Phys.* **31** (1990), 680–686.
- [Vol29] V. A. Volpert, A. I. Volpert, and A. G. Merzhanov, *Application of bifurcation theory to investigation of spin waves of combustion*, *Dokl. Akad. Nauk SSSR* **262** (1982), no. 3, 642–645; English transl. in *Soviet Phys. Dokl.*
- [Vol30] ———, *Analysis of nonunidimensional combustion regimes by bifurcation theory methods*, *Dokl. Phys. Chem.* **263** (1982), 239–242.
- [Vol31] ———, *Application of the theory of bifurcation to the investigation of nonstationary combustion regimes*, *Combust., Expl. and Shock Waves* **18** (1983), 435–438.
- [Vol32] V. A. Volpert, A. V. Dvoryankin, and A. G. Strunina, *Non-one-dimensional combustion of specimens with rectangular cross section*, *Combust., Expl. and Shock Waves* **19** (1983), 377–380.
- [Vol33] V. A. Volpert and S. P. Davtyan, *Existence of waves in combined polymerization–crystallization processes*, *Soviet Phys. Dokl.* **28** (1983), 15–16.
- [Vol34] Vit. A. Volpert, Vl. A. Volpert, and D. S. Davtyan, *Evaluation of combustion wave velocity for condensed media*, Preprint, Inst. Struct. Macrokinetics, Chernogolovka, 1988. (Russian)
- [Vol35] ———, *Application of a minimax method in combustion problems*, *Combust., Expl. and Shock Waves* **26** (1990), 371–376.
- [Vol36] V. A. Volpert and P. M. Krishenik, *Stability in two-stage combustion wave propagation under controlled conditions*, *Combust., Expl. and Shock Waves* **22** (1986), 148–156.
- [Vol37] ———, *Nonsteady propagation of combustion waves in a system of successive reactions with endothermal stages*, *Combust., Expl. and Shock Waves* **22** (1986), 285–292.

- [Vol38] V. A. Volpert, I. N. Megrabova, and S. P. Davtyan, *Determination of combustion and polymerization wave velocity*, Combust., Expl. and Shock Waves **21** (1985), 151–157.
- [Vol39] V. A. Volpert, B. I. Khaikin, and S. I. Khudyaev, *Combustion waves with independent reactions*, Problems of Technological Combustion, vol. 1, Inst. Chem. Phys., Chernogolovka, 1981, pp. 110–113. (Russian)
- [Vol40] Vit. A. Volpert and Vl. A. Volpert, *Propagation velocity estimation for condensed phase combustion*, SIAM J. Appl. Math. **51** (1991), 1074–1089.
- [Vol41] A. I. Volpert and V. A. Volpert, *Travelling waves in kinetic-diffusion systems*, Internat. Conf. “Unstationary Processes in Catalysis”, Novosibirsk, 1990, pp. 579–584.
- [Vol42] ———, *Application of the theory of rotation of vector fields to investigation of traveling waves*, Proc. of the Republican Conference on Nonlinear Problems in Mathematical Physics, Donetsk, 1983. (Russian)
- [Vol43] A. I. Volpert, *Traveling wave solutions of parabolic equations*, Preprint, Inst. Chem. Phys., Chernogolovka, 1983. (Russian)
- [Vol44] V. A. Volpert and A. I. Volpert, *Travelling solutions of monotone parabolic systems*, Preprint No. 146, CNR URA 740, 1993.
- [Vol45] ———, *Stability of waves described by parabolic systems of equations*, Boundary Value Problems for Partial Differential Equations (S. K. Godunov, ed.), Akad. Nauk SSR, Sibirsk. Otdel., Inst. Mat., Novosibirsk, 1990, pp. 20–34. (Russian)
- [Vol46] Vit. A. Volpert, Vl. A. Volpert, S. P. Davtyan, I. N. Megrabova, and N. F. Surkov, *Two-dimensional combustion modes in condensed flow*, SIAM J. Appl. Math. **52** (1992), 368–383.
- [Vol47] A. I. Volpert, *On propagation of waves described by nonlinear parabolic equations*, I. G. Petrovskii. Selected Works. Differential Equations. Probability Theory, “Nauka”, Moscow, 1987, pp. 333–358. (Russian)
- [Vol48] A. I. Volpert and S. I. Khudyaev, *On the Cauchy problem for composite systems of nonlinear differential equations*, Math. USSR-Sb. **16** (1972), 517–544.
- [Vol49] V. A. Volpert and A. I. Volpert, *Bifurcations of waves described by parabolic systems in a circular cylinder*, Differential’nye Uravneniya **21** (1985), no. 6, 1068–1070; English transl. in Differential Equations **21** (1985).
- [Volt1] V. Volterra, *Variazioni e fluttuazioni del numero d’individui in specie animali conviventi*, Mem. Accad. Naz. Lincei **2** (1926); English transl., *Animal ecology*, McGraw-Hill, New York, 1931, pp. 409–448.
- [Vor1] V. G. Voronkov and N. N. Semenov, *Propagation of cold flames in combustible mixtures containing 0.03% carbon disulfide*, Zh. Fiz. Khimii **13** (1939), no. 12, 1695–1727. (Russian)
- [Wan1] W.-P. Wang, *Multiple impulse solutions to McKean’s caricature of the nerve equation. I. Existence*, Comm. Pure Appl. Math. **41** (1988), 71–103.
- [Wan2] ———, *Multiple impulse solutions to McKean’s caricature of the nerve equation. II. Stability*, Comm. Pure Appl. Math. **41** (1988), 997–1025.
- [Wil1] F. A. Williams, *Combustion theory*, Benjamin, Menlo Park, CA, 1985.
- [Win1] A. T. Winfree, *Rotating solutions to reaction-diffusion equations in simply-connected media*, Mathematical Aspects of Chemical and Biochemical Problems and Quantum Chemistry, SIAM AMS Proceedings, vol. 8, Amer. Math. Soc., Providence, RI, 1974, pp. 13–31.
- [Win2] ———, *Stably rotating patterns of reaction-diffusion*, Theoret. Chem. **4** (1978), 1–51.
- [Win3] ———, *Dynamical stability of untwisted scroll rings in excitable media*, Phys. D **35** (1989), 277–288.
- [Xin1] X. Xin, *Existence and uniqueness of traveling waves in a reaction-diffusion equation with combustion nonlinearity*, Indiana Univ. Math. J. **40** (1991), 985–1008.
- [Xin2] ———, *Multidimensional stability of traveling waves in a bistable reaction-diffusion equation. I*, Comm. Partial Differential Equations **17** (1992), 1889–1899.
- [Yan1] E. Yanagida, *Stability of fast travelling pulse solutions of the FitzHugh-Nagumo equations*, J. Math. Biol. **22** (1985), 81–104.
- [Yan2] ———, *Existence of periodic travelling wave solutions of reaction-diffusion systems with fast-slow dynamics*, J. Differential Equations **76** (1988), 115–134.
- [Yan3] E. Yanagida and K. Maginu, *Stability of double-pulse solutions in nerve axon equations*, SIAM J. Appl. Math. **49** (1989), 1158–1173.

- [Ye1] Q.-X. Ye and M.-X. Wang, *Travelling wave front solutions of Noyes-Field system for Belousov-Zhabotinskiĭ reaction*, *Nonlinear Anal.* **11** (1987), 1289–1302.
- [Zai1] P. M. Zaidel' and Ya. B. Zel'dovich, *Possible regimes of stationary combustion*, *Zh. Prikl. Mekh. i Tekhn. Fiz.* (1962), no. 4, 27–32. (Russian)
- [Zel1] Ya. B. Zel'dovich, *A theory of the limit of slow flame propagation*, *Zh. Prikl. Mekh. i Tekhn. Fiz.* **11** (1941), no. 1, 159–169. (Russian)
- [Zel2] Ya. B. Zel'dovich and D. A. Frank-Kamenetskiĭ, *A theory of thermal propagation of flame*, *Acta Physicochim. USSR* **9** (1938), 341–350. (Russian)
- [Zel3] Ya. B. Zel'dovich, *Theory of combustion and detonation of gases*, OGIZ, Academy of Sciences, Moscow, 1944. (Russian)
- [Zel4] ———, *Theory of propagation of flame*, *Zh. Fiz. Khimii* **22** (1948), 27–48; English transl., National Advisory Committee Aeronautics Tech. Memo **1951**, no. 1282.
- [Zel5] Ya. B. Zel'dovich, G. I. Barenblatt, V. B. Librovich, and G. M. Makhviladze, *The mathematical theory of combustion and explosions*, Consultants Bureau, New York, 1985.
- [Zel6] Ya. B. Zeldovich and G. I. Barenblatt, *Theory of flame propagation*, *Combust. Flame* **3** (1959), 61–74.
- [Zel7] Ya. B. Zeldovich and N. N. Semenov, *Kinetics of chemical reactions in flames*, National Advisory Committee Aeronautics Tech. Memo **1946**, no. 1084.
- [Zel8] ———, *J. Exptl. Theoret. Phys. (USSR)* **10** (1940), 1116–1123. (Russian)
- [Zel9] Ya. B. Zeldovich, and V. V. Voevodskiĭ, *Course in the theory of combustion, detonation and explosion. I. Thermal explosion and propagation of flames in gases*, Izdat. Moskov. Mekh. Inst., Moscow, 1947. (Russian)
- [Zel10] Ya. B. Zeldovich and D. A. Frank-Kamenetskiĭ, *Course in the theory of combustion, detonation and explosion. II. Turbulent and heterogeneous combustion*, Izdat. Moskov. Mekh. Inst., Moscow, 1947. (Russian)
- [Zel11] Ya. B. Zeldovich, *Chain reactions in hot flames theory of burning velocity*, *Kinetika i Kataliz* **2** (1961), 305–318. (Russian)
- [Zha1] A. M. Zhabotinskiĭ, *Concentrational self-oscillations*, “Nauka”, Moscow, 1974. (Russian)
- [Zhan1] K. J. Zhang, *Existence of anisotropic traveling wave solutions of a reaction-diffusion system*, *Dongbei Shuxue* **8** (1992), 136–150.
- [Zhi1] A. M. Zhiljaev, A. I. Volpert, and K. G. Skadinskiĭ, *Traveling waves described by parabolic equations containing source and convective terms*, Preprint, Inst. Chem. Phys., Chernogolovka, 1985. (Russian)
- [Zve1] I. N. Zverev and N. N. Smirnov, *Gasdynamics of combustion*, Izdat. Moskov. Gos., Moscow, 1987. (Russian)

Copying and reprinting. Individual readers of this publication, and non-profit libraries acting for them, are permitted to make fair use of the material, such as to copy a chapter for use in teaching or research. Permission is granted to quote brief passages from this publication in reviews, provided the customary acknowledgment of the source is given.

Republication, systematic copying, or multiple reproduction of any material in this publication is permitted only under license from the American Mathematical Society. Requests for such permission should be addressed to the Assistant to the Publisher, American Mathematical Society, P. O. Box 6248, Providence, Rhode Island 02940-6248. Requests can also be made by e-mail to reprint-permission@ams.org.